



Auer Metallprofile

GmbH

ENDKUNDENPREISE | final customer prices

Alle Preise in diesem Katalog: Netto zzgl. MwSt. | all prices in this catalog: net plus VAT



2024

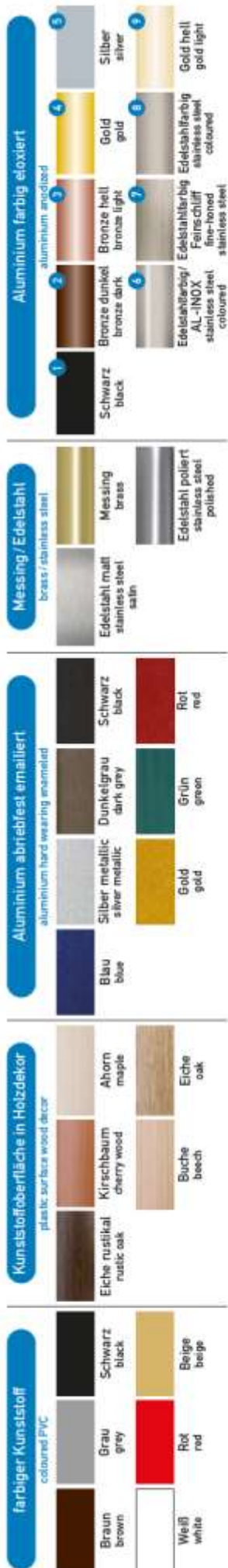

| Koffer Nr./case no. | Seite page | Koffer Nr./case no. | Seite page | Koffer Nr./case no. | Seite page | Koffer Nr./case no. | Seite page | Koffer Nr./case no. | Seite page | Koffer Nr./case no. | Seite page | Koffer Nr./case no. | Seite page | Koffer Nr./case no. | Seite page |
|---------------------|------------|---------------------|------------|---------------------|------------|---------------------|------------|---------------------|------------|---------------------|------------|---------------------|------------|---------------------|------------|
| 1 | 51 | 94 | 16 | 173 | 136 | 244 | 149 | 308 | 98 | 380 | 121 | 444 | 80 | 513 | 90 |
| 2 | 58 | 95 | 9 | 174 | 136 | 246 | 150 | 309 | 90 | 381 | 121 | 447 | 99 | 514 | 91 |
| 3 | 61 | 97 | 10 | 175 | 136 | 248 | 159 | 310 | 117 | 382 | 121 | 448 | 100 | 515 | 91 |
| 4 | 62 | 98 | 20 | 178 | 137 | 249 | 159 | 311 | 35 | 383 | 15 | 449 | 101 | 516 | 96 |
| 5 | 53/54 | 99 | 6 | 179 | 137 | 250 | 65 | 312 | 35 | 384 | 16 | 450 | 102 | 517 | 96 |
| 6 | 56 | 100 | 6 | 180 | 144 | 251 | 93 | 315 | 105 | 385 | 16 | 451 | 103 | 518 | 121/127 |
| 7 | 57 | 101 | 88 | 182 | 146 | 252 | 31 | 316 | 105 | 386 | 26 | 452 | 113 | 519 | 27 |
| 8 | 62 | 105 | 85 | 183 | 146 | 253 | 31 | 317 | 105 | 387 | 75 | 453 | 113 | 520 | 27 |
| 9 | 69 | 108 | 80 | 184 | 147 | 254 | 31 | 318 | 35 | 388 | 7 | 454 | 113 | 521 | 27 |
| 10 | 55 | 109 | 81 | 185 | 147 | 255 | 95 | 319 | 35 | 389 | 8 | 455 | 113 | 522 | 27 |
| 11 | 55 | 110 | 81 | 186 | 147 | 256 | 97 | 320 | 35 | 394 | 30 | 456 | 113 | 523 | 38 |
| 12 | 59/60 | 111 | 82 | 187 | 147 | 257 | 98 | 322 | 133 | 395 | 30 | 457 | 66/114 | 524 | 50 |
| 13 | 52 | 112 | 87 | 189 | 141 | 258 | 79 | 323 | 134 | 396 | 30 | 458 | 66/114 | 525 | 78 |
| 14 | 52 | 119 | 149 | 190 | 141 | 259 | 88 | 324 | 134 | 397 | 47 | 461 | 116 | 526 | 78 |
| 15 | 58 | 120 | 149 | 194 | 145 | 260 | 88 | 325 | 135 | 398 | 47 | 462 | 117 | 527 | 78 |
| 16 | 58 | 121 | 22 | 197 | 142 | 261 | 88 | 326 | 135 | 399 | 31 | 463 | 117 | 528 | 78 |
| 17 | 84 | 127 | 13 | 198 | 143 | 262 | 86 | 327 | 105 | 400 | 31 | 464 | 121 | 529 | 78 |
| 18 | 79 | 128 | 13 | 199 | 143 | 263 | 87 | 328 | 36 | 401 | 31 | 465 | 122 | 530 | 79 |
| 19 | 74 | 129 | 13 | 200 | 143 | 264 | 26 | 329 | 36 | 402 | 31 | 466 | 122 | 531 | 79 |
| 20 | 74 | 130 | 73 | 201 | 33 | 265 | 86 | 330 | 36 | 403 | 31 | 467 | 122 | 532 | 81 |
| 21 | 83 | 131 | 73 | 202 | 33 | 266 | 15 | 331 | 36 | 404 | 31 | 468 | 123 | 533 | 82 |
| 22 | 75 | 132 | 70 | 203 | 33 | 267 | 18 | 332 | 36 | 405 | 31 | 469 | 123 | 534 | 83 |
| 23 | 74 | 133 | 70 | 204 | 33 | 268 | 75 | 333 | 18 | 406 | 32 | 470 | 123 | 535 | 84 |
| 24 | 80 | 134 | 26 | 205 | 20 | 269 | 75 | 334 | 17 | 407 | 32 | 471 | 124 | 536 | 78 |
| 25 | 138 | 135 | 26 | 206 | 34 | 270 | 20 | 336 | 149 | 408 | 32 | 472 | 124 | 537 | 17 |
| 26 | 138 | 136 | 65 | 207 | 34 | 271 | 20 | 337 | 42 | 409 | 32 | 473 | 112 | 538 | 66/114 |
| 27 | 76 | 137 | 71 | 208 | 34 | 272 | 99 | 338 | 42 | 410 | 32 | 474 | 14 | 539 | 66/114 |
| 28 | 76 | 138 | 107 | 209 | 43 | 273 | 100 | 339 | 13 | 411 | 32 | 475 | 14 | 540 | 66/114 |
| 29 | 76 | 139 | 107 | 210 | 44 | 274 | 101 | 340 | 18 | 412 | 64 | 476 | 14 | 541 | 66/114 |
| 30 | 76 | 140 | 107 | 211 | 44 | 275 | 102 | 341 | 17 | 413 | 67/111 | 477 | 45 | 542 | 66/115 |
| 31 | 130 | 141 | 108 | 212 | 45 | 276 | 103 | 342 | 7 | 414 | 67/111 | 478 | 83 | 543 | 66/115 |
| 32 | 127 | 142 | 50 | 213 | 45 | 277 | 104 | 343 | 7 | 415 | 67/111 | 479 | 133 | 544 | 66/115 |
| 33 | 128 | 143 | 50 | 214 | 45 | 278 | 159 | 344 | 8 | 416 | 67/111 | 480 | 77 | 545 | 66/115 |
| 34 | 128 | 144 | 50 | 215 | 45 | 279 | 159 | 345 | 8 | 417 | 67/111 | 481 | 43 | 546 | 66/115 |
| 35 | 129 | 145 | 61 | 216 | 45 | 280 | 159 | 346 | 73 | 418 | 67/111 | 482 | 134 | 547 | 66/115 |
| 36 | 128 | 146 | 22 | 217 | 45 | 281 | 131 | 347 | 73 | 419 | 67/111 | 483 | 138 | 548 | 67/111 |
| 51 | 151 | 147 | 21 | 218 | 45 | 282 | 77 | 348 | 73 | 420 | 67/111 | 484 | 135 | 549 | 67/111 |
| 57 | 151 | 148 | 109 | 219 | 45 | 283 | 77 | 349 | 69 | 421 | 67/111 | 486 | 22 | 550 | 67/111 |
| 68 | 144 | 149 | 109 | 220 | 45 | 284 | 77 | 350 | 63 | 422 | 67/111 | 487 | 23 | 551 | 67/111 |
| 69 | 144 | 150 | 109 | 221 | 45 | 285 | 67/111 | 351 | 106 | 423 | 67/111 | 489 | 25 | 552 | 67/111 |
| 70 | 144 | 151 | 109 | 222 | 45 | 286 | 67/111 | 352 | 31 | 424 | 67/111 | 490 | 25 | 553 | 67/111 |
| 71 | 145 | 152 | 109 | 223 | 112 | 287 | 67/111 | 353 | 31 | 425 | 67/111 | 491 | 28 | 554 | 67/111 |
| 72 | 145 | 153 | 108 | 224 | 112 | 288 | 67/111 | 354 | 31 | 426 | 67/111 | 492 | 28 | 555 | 67/111 |
| 73 | 141 | 154 | 33 | 225 | 112 | 289 | 67/111 | 355 | 31 | 427 | 86 | 493 | 40 | 556 | 67/111 |
| 74 | 140 | 155 | 61 | 226 | 112 | 290 | 67/111 | 356 | 150 | 428 | 66/114 | 494 | 41 | 557 | 67/111 |
| 75 | 140 | 156 | 118 | 227 | 45 | 291 | 67/111 | 357 | 150 | 429 | 140 | 495 | 41 | 558 | 67/111 |
| 76 | 140 | 157 | 118 | 228 | 31 | 292 | 116 | 358 | 150 | 430 | 142 | 496 | 18 | 559 | 67/111 |
| 79 | 159 | 158 | 118 | 229 | 31 | 293 | 116 | 361 | 152 | 431 | 142 | 498 | 96 | 560 | 68 |
| 80 | 25 | 159 | 118 | 230 | 48 | 294 | 116 | 362 | 152 | 432 | 149 | 499 | 96 | 561 | 68 |
| 81 | 21 | 160 | 120 | 231 | 48 | 295 | 116 | 363 | 152 | 433 | 151 | 500 | 24 | 562 | 68 |
| 82 | 21 | 161 | 120 | 232 | 48 | 296 | 116 | 364 | 152 | 434 | 146 | 501 | 84 | 563 | 68 |
| 83 | 12 | 162 | 120 | 233 | 48 | 297 | 116 | 366 | 152 | 435 | 15 | 502 | 85 | 564 | 68 |
| 84 | 12 | 163 | 120 | 234 | 48 | 298 | 66/114 | 367 | 32 | 436 | 15 | 503 | 42 | 565 | 68 |
| 85 | 6 | 164 | 108 | 235 | 46 | 299 | 66/114 | 368 | 32 | 437 | 16 | 504 | 24 | 566 | 68 |
| 86 | 25 | 165 | 129 | 236 | 46 | 300 | 66/114 | 369 | 19 | 438 | 34 | 505 | 24 | 567 | 68 |
| 87 | 9 | 166 | 129 | 237 | 65 | 301 | 125 | 370 | 19 | 439 | 64 | 506 | 71 | 568 | 68 |
| 88 | 4/5 | 167 | 131 | 238 | 65 | 302 | 125 | 371 | 140 | 440 | 64 | 507 | 37 | 569 | 118 |
| 89 | 2/3 | 168 | 131 | 239 | 65 | 303 | 125 | 372 | 7 | 441 | 64 | 508 | 37 | 570 | 119 |
| 90 | 6 | 169 | 131 | 240 | 65 | 304 | 125 | 373 | 23 | 442 | 67/111 | 509 | 37 | 571 | 119 |
| 91 | 10/11 | 170 | 136 | 241 | 47 | 305 | 125 | 374 | 23 | 443 | 67/111 | 510 | 37 | 572 | 119 |
| 92 | 22 | 171 | 136 | 242 | 149 | 306 | 95 | 375 | 23 | 444 | 67/111 | 511 | 40 | 573 | 119 |
| 93 | 85 | 172 | 136 | 243 | 149 | 307 | 97 | 379 | 142 | 445 | 67/111 | 512 | 41 | 574 | 119 |



Dirk Rohde DW - 14
Geschäftsführer
general manager



Manja Ulbricht DW - 10
Geschäftsführerin
general manager



Jan Rohde DW - 21
Produktionsleiter / Vertrieb
production manager / distribution



Jan Ulbricht DW - 29
Vertrieb / Laserbeauftragter
distribution / laser representative



Uwe Albrecht DW - 27
Vertrieb / Reklamations-
beauftragter
distribution / complaint officer



Frank Wollrab DW - 12
Vertrieb
distribution



Nicole Scheppan DW - 15
Auftragsannahme
order acceptance



Angela Rohde DW - 31
Auftragsannahme
order acceptance



Katrin Rohde DW - 16
Buchhaltung
accounting



Kathi Wollrab DW - 28
Rechnungslegung
invoice department



Silke Nostitz DW - 17
Vertrieb
distribution



Carmen Sachse DW - 18
Vertrieb / Marketing
distribution / marketing

Auer.Metallprofile



Die Auer Metallprofile-App

Ihre Profilauswahl für unterwegs – ab jetzt im Apple- und Google-Store erhältlich!

Auer Metallprofile App - your profile selection to go - now available in Apple and Google Store!

Für Angebote und Ausschreibungen:
For inquiries:

Angebot@Auer-Metallprofile.de

Für Ihre Bestellungen:
For your order:

Order@Auer-Metallprofile.de

Für alles andere:
For everything else:

Info@Auer-Metallprofile.de

Unsere AMP - Außendienstmitarbeiter

Our AMP field service employees

Abweichungen möglich – bei Rückfragen +49 (0) 2771 / 20 08-0 | deviations possible – for any questions +49 (0) 2771 / 20 08-0

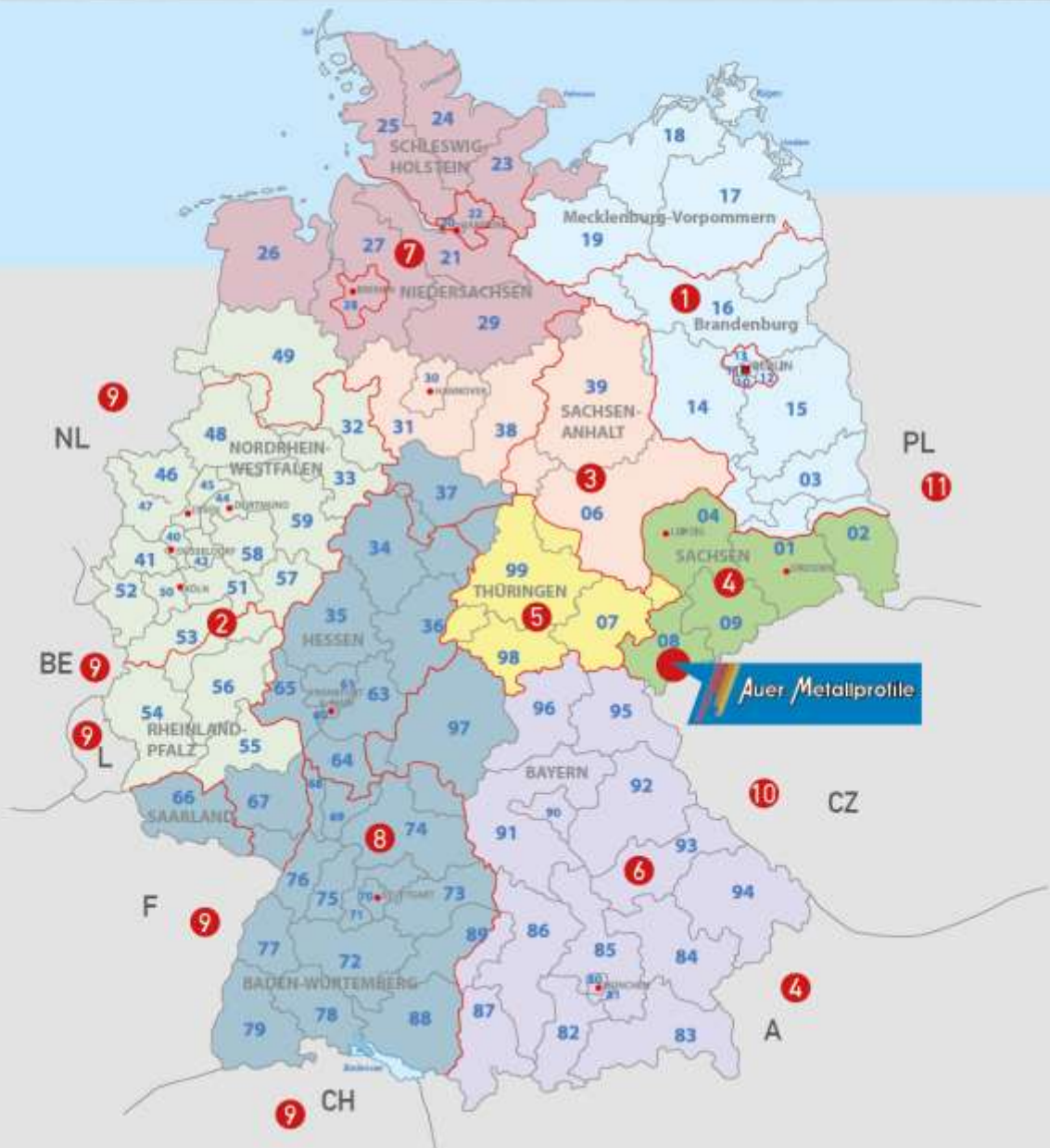

1 Marco Kalbhen
Handelsvertretung

D-14476 Fahrland
Mobil: 0175 / 20 47 971
Email: info@kalma-handel.de
Fax: 033208 / 20 89 66

4 Matthias Bäbler
Handelsvertretung

D-04643 Geithain
Mobil: 0171 / 82 39 292
Email: info@baessler-werkzeug.de
Fax: 034341 / 40 804

7 Andrea Facklam
Handelsvertretung

D-22927 Großhansdorf
Mobil: 0160 / 70 13 414
Email: A.Facklam@t-online.de
Fax: 04102 / 69 14 89

9 Michel Kuentz
E.I.R.L.

F-68740 Rumersheim-Le-Haut
Mobil: 0033 633 / 10 12 56
Email: michelkuentz@orange.fr

2 André Schlepphorst
ABS-Leisten-Vertriebsges.

Mobil: 0151 / 29 50 17 82
Email: Kontakt@ABS-Leisten.de
Schlepphorst@ABS-Leisten.de

5 Marcel Bäbler
Handelsvertretung

D-04654 Frohburg / OT Flößberg
Mobil: 0163 / 47 74 765
Email: info@handelsagentur-baessler.de

8 Silke & Michael Davin
Handelsvertretung

D-63637 Jossgrund-Lettgenbrunn
Fax: 06059 / 90 75 13

Silke Davin
Mobil: 0173 / 35 96 854
Email: silke.davin186@yahoo.de

10 Veronika Burianová
RESKO Tachov s.r.o.

CZ-34701 Tachov
Tel.: 00420 374 / 78 76 52
Mobil: 00420 725 / 92 36 30
Email: info@resko-tachov.cz

3 Martin Paetzel
Handelsvertretung

D-39387 Oschersleben
Mobil: 0177 / 28 78 533
Email: mpae2002@freenet.de
Fax: 03949 / 51 15 80

6 Tanja Wehnl
Handelsagentur

D-91338 Igensdorf
Mobil: 0170 / 21 76 854
Email: tanja.wehnl@handelsagentur-wehnl.de
Fax: 09192 / 99 32 53

Michael Davin
Mobil: 0172 / 61 93 307
Email: michael.davin@t-online.de

11 Grzegorz Matys
Centrum Profili

PL-05-092 Lomianki k / W-yy
Tel.: 0048 502 / 02 90 49
Email: sklep@auer-metallprofile.pl

NEUHEITEN 2024

NEWS 2024

NEU!



NEU:
Treppenkante
80 x 50 x 3 mm
Aluminium
eloxiert

NEW:
stair nosing
80 x 50 x 3 mm
aluminium
anodized



NEU: in 2 m Länge
bei allen Treppenkanten mit
Emaillbeschichtung in
verschiedenen Farben, mit und
ohne nachleuchtenden Rillen

NEW: in 2 m length
at all stair nosings with enamel coating
in different colours, with and
without photoluminescent grooves



NEU: Farben
schwarz und
edelstahlfarbig
bei Eckprofilen 30 x 40 mm.
Aluminium eloxiert

NEW: colours black and
stainless steel coloured
at stair nosings 30 x 40 mm,
aluminium anodized



413 538 - 565



NEU: Breiten 30/35/45 mm
bei Flachprofil/Flachschwelle
Edelstahl matt

NEW: width 30/35/45 mm
at flat threshold
stainless steel matt

566 - 568

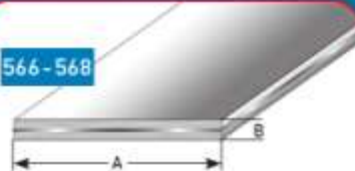

NEU: Verbundschwelle
in Breiten 40/50/60 mm

NEW: composite threshold
in width 40/50/60 mm



530 - 535

NEU: Farbe schwarz
bei Einschubprofile glatt.
Aluminium eloxiert,
mit und ohne Nase,
verschiedene Höhen

NEW: colour black
at insert profile smooth,
aluminium anodized,
with and without nose,
in different heights



31



NEU:
Dehnungsfugenprofil 2 - 6 mm
in Aluminium pressblank
mit schwarzer Silikoneinlage

NEW:
expansion gap profile 2 - 6 mm,
in aluminum mill-finish with black
silicone insert

31



NEU: 3 m Länge
bei Dehnungsfugenprofil
2 - 6 mm, Aluminium
pressblank mit grauer
Silikoneinlage

NEW: 3 m length at expansion
gap profile, aluminum mill-finish,
with gray silicone insert

32



NEU:
Höhen 8/10/11/12,5/15 mm
bei Fliesentrennprofil
Aluminium schwarz eloxiert

NEW:
height: 8/10/11/12,5/15 mm
at tile separation profile
aluminum black anodized

NEUHEITEN 2024

NEWS 2024

NEU!

569

NEU: Maß
100 x 10 x 1.7 mm
Sockelleiste
Typ L100,
Aluminium
stranggepresst

NEW: dimension
100 x 10 x 1.7 mm
skirting type L100,
aluminum extruded



570

NEU:
Außenecke
für L-Sockelleisten,
Druckguss
L40 / L60 /
L80 / L100

NEW: outside corner
for L-skirlings,
diecast
L40 / L60 / L80 / L100



571

NEU:
Innenecke für
L-Sockelleisten,
Druckguss
L40 / L60 /
L80 / L100

NEW: inside corner
for L-skirlingg,
diecast
L40 / L60 /
L80 / L100



572

NEU: Verbinder
für L-Sockelleisten
Druckguss
L40 / L60 /
L80 / L100

NEW: connector
for L-skirlings,
diecast
L40 / L60 /
L80 / L100



573 574

NEU: Endstücke
links und rechts
für L-Sockelleisten
Druckguss
L40 / L60 /
L80 / L100

NEW: end caps
left and right
for L-skirlings,
diecast
L40 / L60 / L80 / L100



25 26

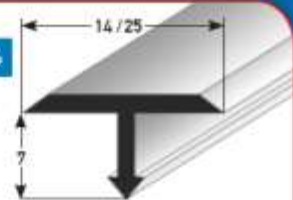

NEU: 3 m Länge
bei T-Profilen 14 und 25 mm,
Edelstahl matt

NEW: 3 m length at T-profiles
14 and 25 mm, stainless steel matt



AMP-Standard-
Musterkoffer

AMP standard
example case 2023



AMP-Läuferstangen-
Musterkoffer

AMP stair rods
example case



1-28

1. Winkelprofile und Treppenkanten aus Aluminium und Messing

1. angle edges and stair nosings out of aluminium + brass

Winkelprofile / Treppenkanten / Vorstoßprofile / Fassonprofile /
 wendbare Treppenseitenprofile / ALU-Treppeninnenecken / Eckprofile
 Kombi-Treppenkanten mit Einlagen / Doppel-einschub-Treppenkanten
 angle edges / stair nosings / edge profiles / fasson stair nosings /
 turnable stair side profiles / aluminium stair inside corners / corner profiles
 combination stair nosings with inserts / double insert stair nosings

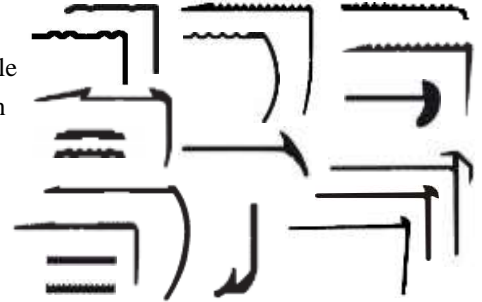

29-38

2. Treppenkanten aus Edelstahl

2. stair nosings out of stainless steel

Edelstahl-Treppenkanten: *INOX PROTECT* / *profilierte Riffelung* /
gefräste Riffelung / *Prägelochung* / *Prägelochung + Anker* /
gezogen V4A / *Noppenprägung* / *Fliesen-Treppenkante* /
 Edst.-Einschubprofile mit Nase / Edst.-Treppeninnenecken
 stainless steel stair nosing: *INOX PROTECT* / fluted riffle / antislip fluting /
 embossed punching / embossed punching + anchor / drawn V4A / nub embossing /
 tile stair nosing / stainless steel nosed insert profile / stainless steel stair inside corner



39-48

3. Wand-, Kantenschutz- & Spezialprofile aus Edelstahl + Aluminium + Messing

3. wall + corner protection and special profiles out of stainless steel + aluminium + brass

Wandprofile / Eckschutzwinkel / Edelstahl-Deko-Winkel /
 Edst.-Einschubprofile / Edst.-Ausgleichsprofile /
 Miniwinkel Edelstahl + Messing / Edelstahl-Spezialprofile
 wall profiles / corner protection angles / stainless steel deco-angles /
 stainless steel insert profiles / stainless steel leveling profiles /
 stainless steel special profiles

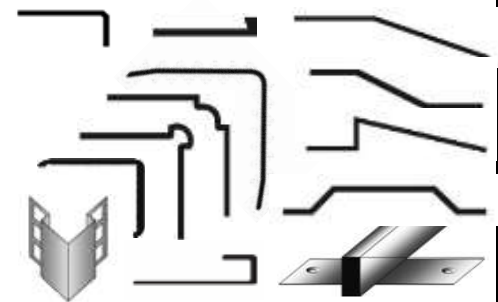

49-71

4. Übergangsprofile aus Aluminium, Edelstahl und Messing

4. connecting profiles out of aluminium + stainless steel + brass

Übergangsprofile Aluminium / Messing / Edelstahl /
 Edelstahl-Übergangsprofile: *profilierte Riffelung* / *gezogen V4A* /
gekantet / *Flachschwellen* / *INOX PROTECT* /
 Aluminium-Flachschwellen / Abschlussprofile /
 Anpassungsprofile / Sockelprofile
 connecting profiles aluminium / brass / stainless steel /
 stainless steel cover profiles: fluted riffle / drawn V4A / edged / flat threshold / *INOX PROTECT* /
 aluminium flat threshold / adaptation profiles / levelling profiles / plinth profiles



72-88 **5. Einschub- und Anstoßprofile aus Aluminium**
 5. insert profiles out of aluminium

ein- & doppelseitige Einschubprofile mit & ohne Nase /
 Doppel- / Einfach- / Miniklemmprofile / Anstoßprofile /
 Rampenprofile / Einfassschienen
 one and double sided insert profiles with and without nose /
 double-/ single-/ mini clamping profiles / ramp profiles /

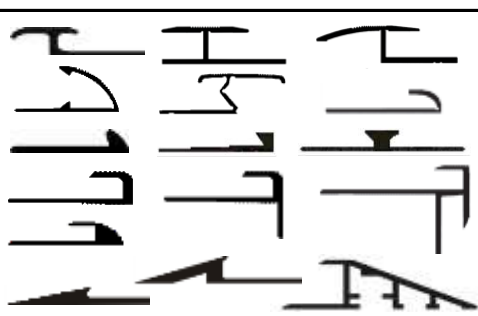

89-93 **6. LED und Service**
 6. LED + service

LED-Treppenkanten direkt + indirekt / LED-Sckelleisten indirekt/
 Serviceleistungen / ausklinken & biegen / Säulenringe biegen
 LED stair nosing direct + indirect / LED skirting indirect
 service / flanges notched + bent / pillar ring bent



94-109 **7. Systemprofile aus Aluminium und Edelstahl für 4 - 24 mm Beläge**
 7. system profiles out of aluminium + stainless steel for 4 - 24 mm floorings

MINI-APL-System 5-9 mm /
 APL-System 7-15 mm /
 MINI-APL-Klick-System 4-7 mm /
 APL-Klick-System 7-10 / 11-15 / 15-24 mm /
 SKD-System 4-7 mm /
 SLP-System 7-17 / 12-22 mm
 MINI-APL-system 5-9 mm / APL-system 7-15 mm /
 MINI-APL-click-system 4-7 mm / APL-click-system 7-10 / 11-15 / 15-24 mm /
 SKD-system 4-7 mm / SLP-system 7-17 / 12-22 mm

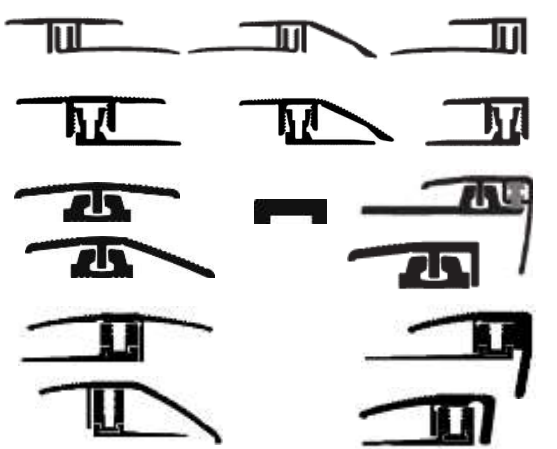

110-121 **8. Sockelleisten aus Edelstahl und Aluminium**
 8. skirtings out of stainless steel + aluminium

Edelstahl-Sockelleisten: TYP I / L / J / r -Form + Ecken /
 Aluminium-Sockelleisten:
 Sockelleisten TYP I / L / J / r -Form + Zubehör /
 Sockelleisten Contego + Zubehör / Sockelblech /
 Design-Einklebe-Sockel. / Klick-Sockelleisten + Zubehör
 stainless steel skirtings type I / L / J / r-form + corners /
 aluminium: skirtings type I / L / J / r-form + accessories / skirting metal sheet /
 skirtings Contego + accessories / design skirting / click-skirting + accessories

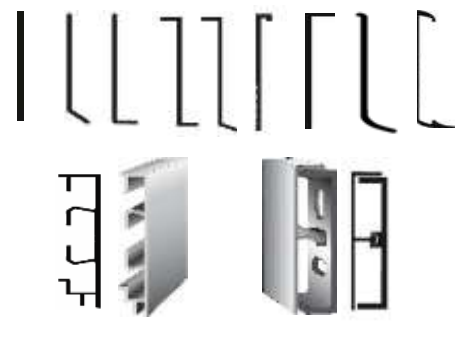

Seite/
page

Produktkategorien/ product categories

Form/ shape

126-138 9. Fliesentrenn-, Dehnungsfugen-, Bau- & T-Profile aus Aluminium, Edelstahl, Messing & PVC
 9. ceramic tile separation profiles + expansion gap profiles out of aluminium + stainless steel + brass + PVC

Fliesentrennprofile / Flexible Fliesentrennpr. / Dehnungsfugenprofile /
 Spezial-Dehnungsfugenprofile, Fugenbreite bis 20 mm /
 SUPER-Dehnungsfugenprofile, Fugenbreite 20/ 35 mm /
 Wellenverbinder / Bauprofile:
 Winkel / U-Profile / T-Profile + Befestigung / Rohre /
 Flachprofile / Vierkantrohre
 ceramic tile separation profiles / flexible ceramic tile separation profiles /
 expansion gap profiles / special expansion gap profile, over 20 mm joint width /
 wave connector / super expansion gap profile, joint width 20/ 35 mm /
 T-profiles + fastening / pipes / flat profiles / rectangular pipes

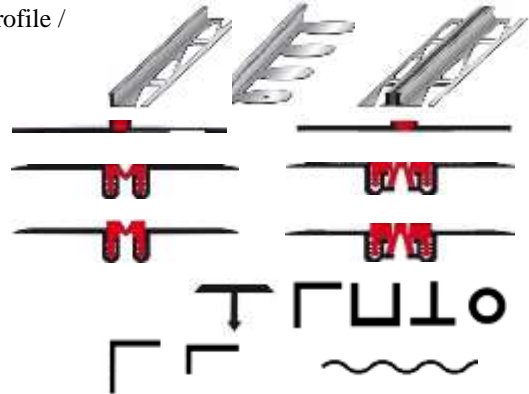

139-147 10. Läuferstangen aus Messing und Edelstahl
 10. stair rods out of brass + stainless steel

Läuferstange Ø 10 / 13 / 16 / 25 mm + Zubehör /
 Dreikantläuferstange 16x16 mm + Zubehör /
 Teppichschrauben & -nägel
 stair rod Ø 10 / 13 / 16 / 25 mm + accessories /
 triangular stair rod 16x16 mm + accessories / carpet screws + carpet nails



148-152 11. Reparaturwinkel f. Treppen und PVC-Profile
 11. repair angles for stairs + PVC profiles

Reparaturwinkel Edelstahl + verzinkter Stahl / Rund-Reparaturwinkel /
 PVC-Profile:
 PVC-Einfassleisten ein- u. doppelseitig / PVC-Übergangsprofil /
 Stufenmattenwinkel / Knickwinkel / Weichsockelleisten /
 Hohlkehldprofil / PVC-Treppenkanten
 repair angles stainless steel + galvanized steel / round repair angles /
 PVC profiles: insert profiles single and double-sided / PVC connecting profile /
 PVC-angles for stair mats / edge profiles / soft skirtings / hollow profile / stair nosings

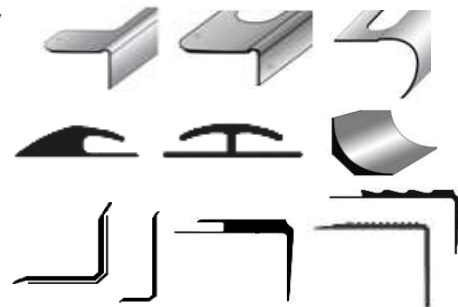

153-160 12. Zubehör
 12. accessories

Fußbodenverlegebänder / Montagekleber / Schrauben / Dübel /
 Ringnägel / Leistenstifte / Türstopper / Wegmarkierungsronden /
 Edelst.-Heizrohrrosetten / Lüftungsbleche
 tapes / builders adhesive / screws / dowels / riffled nails / pins / door stopper /
 trail marker ronden / stainless steel heating pipe rosettes



161-165 13. Hinweise und AGB
 13. hints + terms and conditions

Verlegehinweise / AGB - Liefer- & Zahlungsbedingungen
 installation tips / terms and conditions - delivery and payment

Register/ register

| | |
|---|-----------|
| 1. Winkelprofile und Treppenkanten aus Aluminium und Messing | 1 |
| 1. angle edges and stair nosings out of aluminium + brass | |
| 2. Treppenkanten aus Edelstahl | 2 |
| 2. stair nosings out of stainless steel | |
| 3. Wand-, Kantenschutz- und Spezialprofile aus Edelstahl, Aluminium & Messing | 3 |
| 3. wall, corner protection and special profiles out of stainless steel + aluminium + brass | |
| 4. Übergangprofile aus Aluminium, Edelstahl und Messing | 4 |
| 4. connecting profiles out of aluminium + stainless steel + brass | |
| 5. Einschub- und Anstoßprofile aus Aluminium | 5 |
| 5. insert profiles out of aluminium | |
| 6. LED + Service | 6 |
| 6. LED + service | |
| 7. Systemprofile aus Aluminium und Edelstahl für 4 - 24 mm Beläge | 7 |
| 7. system profiles out of aluminium + stainless steel for 4 - 24 mm floorings | |
| 8. Sockelleisten aus Edelstahl und Aluminium | 8 |
| 8. skirtings out of stainless steel + aluminium | |
| 9. Fliesentrenn-, Dehnungsfugen-, Bau- & T-Profile aus Aluminium, Edelstahl, Messing & PVC | 9 |
| 9. ceramic tile separation profiles + expansion gap profiles out of aluminium + stainless steel + brass + PVC | |
| 10. Läuferstangen aus Messing und Edelstahl | 10 |
| 10. stair rods out of brass + stainless steel | |
| 11. Reparaturwinkel f. Treppen und PVC-Profile | 11 |
| 11. repair angles for stairs + PVC profiles | |
| 12. Zubehör | 12 |
| 12. accessories | |
| 13. Hinweise und AGB | 13 |
| 13. hints + terms and conditions | |

1. WINKELPROFILE + TREPPENKANTEN AUS ALUMINIUM UND MESSING

1. ANGLE EDGES + STAIR NOSINGS
OUT OF ALUMINIUM AND BRASS



1. WINKELPROFILE + TREPPENKANTEN AUS ALUMINIUM + MESSING / 1. ANGLE EDGES + STAIR NOSINGS ALU + BRASS

Andere Eloxalfarben siehe Abschnitt 6,
 Lieferzeit 14 Tage/ other anodized colours
 see section 6, delivery time 14 days

| Profi-Pack à 10 Stück im Bund | | | |
|--------------------------------|-----------|-----------|-------------|
| professional packing à 10 pcs. | | | |
| Farbe/colour | L / l (m) | Art./ref. | €/Stk./pcs. |

| SB-Pack incl. Schr./ Dübel; VE 20 Stk. | |
|---|-------------|
| self-service-pack with screws/ dowels; à 20 pcs. | |
| Art./ref. | €/Stk./pcs. |

89 Winkelprofil 10 x 24,5 mm, Aluminium eloxiert, gebohrt

angle edge 10 x 24,5 mm,
 aluminium anodized, drilled



| | | | |
|---|-----|---------|-------|
| silberfarbig silver | 0,8 | 04480-2 | 3,92 |
| | 0,9 | 04490-1 | 4,38 |
| | 1,0 | 04500-7 | 4,88 |
| | 1,2 | 04510-6 | 5,86 |
| | 2,0 | 04520-5 | 9,78 |
| goldfarbig gold | 2,7 | 04530-4 | 13,20 |
| | 0,8 | 04580-9 | 4,90 |
| | 0,9 | 04590-8 | 5,54 |
| | 1,0 | 04600-4 | 6,14 |
| | 1,2 | 04610-3 | 7,38 |
| bronzefarbig hell bronze light | 2,0 | 04620-2 | 12,28 |
| | 2,7 | 04630-1 | 16,60 |
| | 0,8 | 04680-6 | 5,20 |
| | 0,9 | 04690-5 | 5,86 |
| | 1,0 | 04700-1 | 6,52 |
| bronzefarbig dunkel bronze dark | 1,2 | 04710-0 | 7,80 |
| | 2,0 | 04720-9 | 13,04 |
| | 2,7 | 04730-8 | 17,58 |
| | 0,8 | 04780-3 | 5,20 |
| | 0,9 | 04790-2 | 5,86 |
| gold hell gold light | 1,0 | 04800-8 | 6,52 |
| | 1,2 | 04810-7 | 7,80 |
| | 2,0 | 04820-6 | 13,04 |
| | 2,7 | 04830-5 | 17,58 |
| | 0,8 | 70580-2 | 4,90 |
| edelstahlfarbig Feinschliff fine-honed stainless steel coloured | 0,9 | 70582-6 | 5,54 |
| | 1,0 | 70584-0 | 6,14 |
| | 1,2 | 70586-4 | 7,38 |
| | 2,0 | 70588-8 | 12,28 |
| | 2,7 | 70590-1 | 16,60 |
| schwarz black | 0,8 | 70592-5 | 5,20 |
| | 0,9 | 70594-9 | 5,86 |
| Eiche | 1,0 | 70596-3 | 6,52 |
| | 1,2 | 70598-7 | 7,80 |
| Ahorn | 2,0 | 70600-7 | 13,04 |
| | 2,7 | 70602-1 | 17,58 |
| Kirschbaum | 1,0 | 72024-9 | 6,52 |
| | 2,7 | 72026-3 | 17,58 |

| | |
|---------|-------|
| 04491-8 | 5,26 |
| 04501-4 | 5,76 |
| 04521-2 | 11,52 |
| 04531-1 | 15,82 |
| 04591-5 | 6,48 |
| 04601-1 | 7,04 |
| 04621-9 | 14,26 |
| 04631-8 | 19,46 |
| 04691-2 | 6,94 |
| 04701-8 | 7,60 |
| 04721-6 | 15,22 |
| 04731-5 | 20,88 |
| 04791-9 | 6,80 |
| 04801-5 | 7,46 |
| 04821-3 | 14,94 |
| 04831-2 | 20,44 |
| 70604-5 | 6,48 |
| 70606-9 | 7,04 |
| 70608-3 | 14,26 |
| 70610-6 | 19,46 |
| 70612-0 | 6,80 |
| 70614-4 | 7,46 |
| 70616-8 | 14,94 |
| 70618-2 | 20,44 |
| 72028-7 | 7,46 |
| 72030-0 | 20,44 |

Holzdekorfolie/ wood decor

| | | | |
|------------------------------|-----|---------|-------|
| Buche beech | 1,0 | 38700-8 | 11,28 |
| | 2,7 | 38710-7 | 30,52 |
| Eiche oak | 1,0 | 38720-6 | 11,28 |
| | 2,7 | 38730-5 | 30,52 |
| Ahorn maple | 1,0 | 38740-4 | 11,28 |
| | 2,7 | 38750-3 | 30,52 |
| Kirschbaum cherry wood | 1,0 | 38760-2 | 11,28 |
| | 2,7 | 38765-7 | 30,52 |
| Eiche rustikal rustic oak | 1,0 | 38770-1 | 11,28 |
| | 2,7 | 38775-6 | 30,52 |

| | |
|---------|-------|
| 38701-5 | 12,30 |
| 38711-4 | 33,24 |
| 38721-3 | 12,30 |
| 38731-2 | 33,24 |
| 38741-1 | 12,30 |
| 38751-0 | 33,24 |
| 38761-9 | 12,30 |
| 38766-4 | 33,24 |
| 38771-8 | 12,30 |
| 38776-3 | 33,24 |

1. WINKELPROFILE + TREPPENKANTEN AUS ALUMINIUM + MESSING / 1. ANGLE EDGES + STAIR NOSINGS ALU + BRASS

Andere Eloxalfarben siehe Abschnitt 6,
 Lieferzeit 14 Tage/ other anodized colours
 see section 6, delivery time 14 days

| Profi-Pack à 10 Stück im Bund | | | |
|--------------------------------|-----------|-----------|-------------|
| professional packing à 10 pcs. | | | |
| Farbe/colour | L / l (m) | Art./ref. | €/Stk./pcs. |

| SB-Pack incl. Schr./ Dübel; VE 20 Stk. | |
|---|-------------|
| self-service-pack with screws/ dowels; à 20 pcs. | |
| Art./ref. | €/Stk./pcs. |

8 9 Winkelprofil 10 x 24,5 mm, Aluminium eloxiert, selbstklebend

angle edge 10 x 24,5 mm,
 aluminium anodized,
 self adhesive



| | | | |
|---|-----|---------|-------|
| silberfarbig silver | 1,0 | 04503-8 | 6,52 |
| | 2,7 | 04533-5 | 17,58 |
| goldfarbig gold | 1,0 | 04603-5 | 7,90 |
| | 2,7 | 04633-2 | 21,32 |
| bronzef. hell bronze light | 1,0 | 04703-2 | 8,26 |
| | 2,7 | 04733-9 | 22,32 |
| bronzef. dunkel bronze dark | 1,0 | 04803-9 | 8,26 |
| | 2,7 | 04833-6 | 22,32 |
| gold hell gold light | 1,0 | 70622-9 | 7,90 |
| | 2,7 | 70624-3 | 21,32 |
| edelstahlfarbig Feinschliff fine-honed stainless steel coloured | 1,0 | 70626-7 | 8,26 |
| | 2,7 | 70628-1 | 22,32 |
| schwarz black | 1,0 | 72032-4 | 8,26 |
| | 2,7 | 72034-8 | 22,32 |

| | |
|---------|-------|
| 04502-1 | 7,40 |
| 04532-8 | 20,02 |
| 04602-8 | 8,90 |
| 04632-5 | 23,94 |
| 04702-5 | 9,24 |
| 04732-2 | 24,92 |
| 04802-2 | 9,24 |
| 04832-9 | 24,92 |
| 70630-4 | 8,90 |
| 70632-8 | 23,94 |
| 70634-2 | 9,24 |
| 70636-6 | 24,92 |
| 72036-2 | 9,24 |
| 72038-6 | 24,92 |

| Holzdekorfolie/ wood decor | | | |
|------------------------------|----------------|---------|---------|
| | Buche beech | 1,0 | 38640-7 |
| 2,7 | | 38650-6 | 37,42 |
| Eiche oak | 1,0 | 38660-5 | 13,88 |
| | 2,7 | 38670-4 | 37,42 |
| Ahorn maple | 1,0 | 38680-3 | 13,88 |
| | 2,7 | 38690-2 | 37,42 |
| Kirschbaum cherry wood | 1,0 | 38780-0 | 13,88 |
| | 2,7 | 38785-5 | 37,42 |
| Eiche rustikal rustic oak | 1,0 | 38790-9 | 13,88 |
| | 2,7 | 38795-4 | 37,42 |

| | |
|---------|-------|
| 38641-4 | 14,46 |
| 38651-3 | 39,12 |
| 38661-2 | 14,46 |
| 38671-1 | 39,12 |
| 38681-0 | 14,46 |
| 38691-9 | 39,12 |
| 38781-7 | 14,46 |
| 38786-2 | 39,12 |
| 38791-6 | 14,46 |
| 38796-1 | 39,12 |

1. WINKELPROFILE + TREPPENKANTEN AUS ALUMINIUM + MESSING / 1. ANGLE EDGES + STAIR NOSINGS ALU + BRASS

Andere Eloxalfarben siehe
 Abschnitt 6, Lieferzeit 14 Tage
 other anodized colours see section 6,
 delivery time 14 days

| Profi-Pack à 10 Stück im Bund | | | |
|--------------------------------|-----------|-----------|-------------|
| professional packing à 10 pcs. | | | |
| Farbe/colour | L / l (m) | Art./ref. | €/Stk./pcs. |

| SB-Pack incl. Schr./ Dübel; VE 20 Stk. | |
|---|-------------|
| self-service-pack with screws/ dowels; à 20 pcs. | |
| Art./ref. | €/Stk./pcs. |

8 8 Winkelprofil 18 x 24,5 mm, Aluminium eloxiert, gebohrt

angle edge 18 x 24,5 mm,
 aluminium anodized, drilled



| | | | |
|---|-----|---------|-------|
| silberfarbig silver | 0,8 | 04080-4 | 4,38 |
| | 0,9 | 04090-3 | 4,96 |
| | 1,0 | 04100-9 | 5,50 |
| | 1,2 | 04110-8 | 6,60 |
| | 2,0 | 04120-7 | 11,00 |
| goldfarbig gold | 2,7 | 04130-6 | 14,86 |
| | 0,8 | 04180-1 | 6,00 |
| | 0,9 | 04190-0 | 6,78 |
| | 1,0 | 04200-6 | 7,52 |
| | 1,2 | 04210-5 | 9,02 |
| bronzefarbig hell bronze light | 2,0 | 04220-4 | 15,04 |
| | 2,7 | 04230-3 | 20,26 |
| | 0,8 | 04280-8 | 6,38 |
| | 0,9 | 04290-7 | 7,18 |
| | 1,0 | 04300-3 | 7,94 |
| bronzefarbig dunkel bronze dark | 1,2 | 04310-2 | 9,54 |
| | 2,0 | 04320-1 | 15,88 |
| | 2,7 | 04330-0 | 21,50 |
| | 0,8 | 04380-5 | 6,38 |
| | 0,9 | 04390-4 | 7,18 |
| gold hell gold light | 1,0 | 04400-0 | 7,94 |
| | 1,2 | 04410-9 | 9,54 |
| | 2,0 | 04420-8 | 15,88 |
| | 2,7 | 04430-7 | 21,50 |
| | 0,8 | 70640-3 | 6,00 |
| edelstahlfarbig Feinschliff fine-honed stainless steel coloured | 0,9 | 70642-7 | 6,78 |
| | 1,0 | 70644-1 | 7,52 |
| | 1,2 | 70646-5 | 9,02 |
| | 2,0 | 70648-9 | 15,04 |
| | 2,7 | 70650-2 | 20,26 |
| schwarz black | 0,8 | 70652-6 | 6,38 |
| | 0,9 | 70654-0 | 7,18 |
| | 1,0 | 70656-4 | 7,94 |
| | 1,2 | 70658-8 | 9,54 |
| | 2,0 | 70660-1 | 15,88 |
| Holzdekorfolie/ wood decor | 2,7 | 70662-5 | 21,50 |
| | 1,0 | 72040-9 | 7,94 |
| | 2,7 | 72042-3 | 21,50 |
| | 1,0 | 38520-2 | 12,62 |
| | 2,7 | 38530-1 | 34,16 |
| Buche beech | 1,0 | 38540-0 | 12,62 |
| | 2,7 | 38550-9 | 34,16 |
| Eiche oak | 1,0 | 38560-8 | 12,62 |
| | 2,7 | 38570-7 | 34,16 |
| Ahorn maple | 1,0 | 38580-6 | 12,62 |
| | 2,7 | 38585-1 | 34,16 |
| Kirschbaum cherry wood | 1,0 | 38590-5 | 12,62 |
| | 2,7 | 38595-0 | 34,16 |
| Eiche rustikal rustic oak | 1,0 | | |
| | 2,7 | | |

| | |
|---------|-------|
| 04091-0 | 5,84 |
| 04101-6 | 6,38 |
| 04121-4 | 12,76 |
| 04131-3 | 17,48 |
| 04191-7 | 7,72 |
| 04201-3 | 8,48 |
| 04221-1 | 16,96 |
| 04231-0 | 23,16 |
| 04291-4 | 8,24 |
| 04301-0 | 9,02 |
| 04321-8 | 18,06 |
| 04331-7 | 24,76 |
| 04391-1 | 8,08 |
| 04401-7 | 8,90 |
| 04421-5 | 17,80 |
| 04431-4 | 24,34 |
| 70664-9 | 7,72 |
| 70666-3 | 8,48 |
| 70668-7 | 16,96 |
| 70670-0 | 23,16 |
| 70672-4 | 8,08 |
| 70674-8 | 8,90 |
| 70676-2 | 17,80 |
| 70678-6 | 24,34 |
| 72044-7 | 8,90 |
| 72046-1 | 24,34 |

| | | | |
|------------------------------|-----|---------|-------|
| Buche beech | 1,0 | 38520-2 | 12,62 |
| | 2,7 | 38530-1 | 34,16 |
| Eiche oak | 1,0 | 38540-0 | 12,62 |
| | 2,7 | 38550-9 | 34,16 |
| Ahorn maple | 1,0 | 38560-8 | 12,62 |
| | 2,7 | 38570-7 | 34,16 |
| Kirschbaum cherry wood | 1,0 | 38580-6 | 12,62 |
| | 2,7 | 38585-1 | 34,16 |
| Eiche rustikal rustic oak | 1,0 | 38590-5 | 12,62 |
| | 2,7 | 38595-0 | 34,16 |

| | |
|---------|-------|
| 38521-9 | 13,62 |
| 38531-8 | 36,80 |
| 38541-7 | 13,62 |
| 38551-6 | 36,80 |
| 38561-5 | 13,62 |
| 38571-4 | 36,80 |
| 38581-3 | 13,62 |
| 38586-8 | 36,80 |
| 38591-2 | 13,62 |
| 38596-7 | 36,80 |

1. WINKELPROFILE + TREPPENKANTEN AUS ALUMINIUM + MESSING / 1. ANGLE EDGES + STAIR NOSINGS ALU + BRASS

Andere Eloxalfarben siehe
 Abschnitt 6, Lieferzeit 14 Tage
 other anodized colours see section 6,
 delivery time 14 days

| Profi-Pack à 10 Stück im Bund | | | |
|--------------------------------|-----------|-----------|-------------|
| professional packing à 10 pcs. | | | |
| Farbe/colour | L / l (m) | Art./ref. | €/Stk./pcs. |

| SB-Pack incl. Schr./ Dübel; VE 20 Stk. | |
|---|-------------|
| self-service-pack with screws/ dowels; à 20 pcs. | |
| Art./ref. | €/Stk./pcs. |

8 8 Winkelprofil 18 x 24,5 mm, Aluminium eloxiert, selbstklebend

angle edge 18 x 24,5 mm,
 aluminium anodized, self
 adhesive



| | | | |
|---|-----|---------|-------|
| silberfarbig silver | 1,0 | 04103-0 | 7,14 |
| | 2,7 | 04133-7 | 19,24 |
| goldfarbig gold | 1,0 | 04203-7 | 8,98 |
| | 2,7 | 04233-4 | 24,24 |
| bronzef. hell bronze light | 1,0 | 04303-4 | 9,42 |
| | 2,7 | 04333-1 | 25,32 |
| bronzef. dunkel bronze dark | 1,0 | 04403-1 | 9,42 |
| | 2,7 | 04433-8 | 25,32 |
| gold hell gold light | 1,0 | 70682-3 | 8,98 |
| | 2,7 | 70684-7 | 24,24 |
| edelstahlfarbig Feinschliff fine-honed stainless steel coloured | 1,0 | 70686-1 | 9,42 |
| | 2,7 | 70688-5 | 25,32 |
| schwarz black | 1,0 | 72048-5 | 9,42 |
| | 2,7 | 72050-8 | 25,32 |

| | |
|---------|-------|
| 04102-3 | 8,04 |
| 04132-0 | 21,68 |
| 04202-0 | 9,92 |
| 04232-7 | 26,80 |
| 04302-7 | 10,34 |
| 04332-4 | 27,88 |
| 04402-4 | 10,34 |
| 04432-1 | 27,88 |
| 70690-8 | 9,92 |
| 70692-2 | 26,80 |
| 70694-6 | 10,34 |
| 70696-0 | 27,88 |
| 720522 | 10,34 |
| 720546 | 27,88 |

| | | | | |
|----------------------------|------------------------------|-----|---------|-------|
| Holzdekorfolie/ wood decor | Buche beech | 1,0 | 38460-1 | 15,22 |
| | | 2,7 | 38470-0 | 41,10 |
| | Eiche oak | 1,0 | 38480-9 | 15,22 |
| | | 2,7 | 38490-8 | 41,10 |
| | Ahorn maple | 1,0 | 38500-4 | 15,22 |
| | | 2,7 | 38510-3 | 41,10 |
| | Kirschbaum cherry wood | 1,0 | 38600-1 | 15,22 |
| | | 2,7 | 38605-6 | 41,10 |
| | Eiche rustikal rustic oak | 1,0 | 38610-0 | 15,22 |
| | | 2,7 | 38615-5 | 41,10 |

| | |
|---------|-------|
| 38461-8 | 15,84 |
| 38471-7 | 42,82 |
| 38481-6 | 15,84 |
| 38491-5 | 42,82 |
| 38501-1 | 15,84 |
| 38511-0 | 42,82 |
| 38601-8 | 15,84 |
| 38606-3 | 42,82 |
| 38611-7 | 15,84 |
| 38616-2 | 42,82 |

1. WINKELPROFILE + TREPPENKANTEN AUS ALUMINIUM + MESSING / 1. ANGLE EDGES + STAIR NOSINGS ALU + BRASS

Andere Eloxalfarben siehe
 Abschnitt 6, Lieferzeit 14 Tage
 other anodized colours see section 6,
 delivery time 14 days

| Profi-Pack à 10 Stück im Bund | | | |
|--------------------------------|-----------|-----------|-------------|
| professional packing à 10 pcs. | | | |
| Farbe/colour | L / l (m) | Art./ref. | €/Stk./pcs. |

| SB-Pack incl. Schr./ Dübel; VE 20 Stk. | |
|---|-------------|
| self-service-pack with screws/ dowels; à 20 pcs. | |
| Art./ref. | €/Stk./pcs. |

90 Treppenkante 20 x 20 mm, Aluminium eloxiert, gebohrt

stair nosing 20 x 20 mm,
 aluminium anodized, drilled

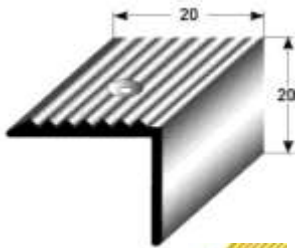

100

| | | | |
|--------------------------------|-----|---------|-------|
| silberfarbig silver | 1,0 | 39500-3 | 6,80 |
| | 2,7 | 39510-2 | 18,36 |
| goldfarbig gold | 1,0 | 39520-1 | 7,66 |
| | 2,7 | 39530-0 | 20,70 |
| bronzef. hell bronze light | 1,0 | 39540-9 | 8,18 |
| | 2,7 | 39550-8 | 22,14 |
| bronzef. dunkel bronze dark | 1,0 | 39560-7 | 8,18 |
| | 2,7 | 39570-6 | 22,14 |

| | |
|---------|-------|
| 39501-0 | 7,74 |
| 39511-9 | 20,80 |
| 39521-8 | 8,62 |
| 39531-7 | 23,20 |
| 39541-6 | 9,62 |
| 39551-5 | 25,98 |
| 39561-4 | 9,12 |
| 39571-3 | 24,74 |

| MESSING poliert brass polished | | | |
|-----------------------------------|---------|-------|--|
| 1,0 | 28733-9 | 31,24 | |
| 2,5 | 28730-8 | 78,08 | |

| | |
|---------|-------|
| 28732-2 | 32,56 |
| 28731-5 | 81,54 |

Bitte fordern Sie unsere Pflegehinweise für Messingprofile an! / Please ask for our care tips for brass profiles!

85 Treppenkante 30 x 30 mm, Aluminium eloxiert, gebohrt

stair nosing 30 x 30 mm,
 aluminium anodized, drilled

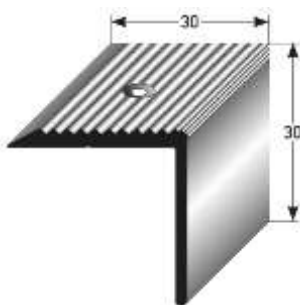

99

| | | | |
|--------------------------------|-----|---------|-------|
| silberfarbig silver | 0,9 | 31450-9 | 8,10 |
| | 1,0 | 31455-4 | 9,00 |
| | 2,7 | 31460-8 | 24,30 |
| goldfarbig gold | 0,9 | 31465-3 | 10,82 |
| | 1,0 | 31470-7 | 12,08 |
| | 2,7 | 31475-2 | 32,54 |
| bronzef. hell bronze light | 0,9 | 31480-6 | 12,28 |
| | 1,0 | | 13,62 |
| | 2,7 | 31490-5 | 36,82 |
| bronzef. dunkel bronze dark | 0,9 | 31495-0 | 12,28 |
| | 1,0 | 31500-1 | 13,62 |
| | 2,7 | 31505-6 | 36,82 |

| | |
|---------|-------|
| 31456-1 | 9,92 |
| 31461-5 | 26,74 |
| 31471-4 | 13,04 |
| 31476-9 | 35,14 |
| 31486-8 | 15,04 |
| 31491-2 | 40,64 |
| 31501-8 | 14,60 |
| 31506-3 | 39,40 |

| MESSING poliert brass polished | | | |
|-----------------------------------|---------|--------|--|
| 1,0 | 28752-0 | 51,92 | |
| 2,5 | 28750-6 | 129,82 | |

| | |
|---------|--------|
| 28753-7 | 53,08 |
| 28751-3 | 133,24 |

Bitte fordern Sie unsere Pflegehinweise für Messingprofile an! / Please ask for our care tips for brass profiles!

Aluminium mit abriebfester Spezialmaillierung, gebohrt/ aluminium enameled, hard wearing, drilled



Edelstahl-Emaillbeschichtung
 Farbton - dunkelgrau

stainless steel-enameled, colour - dark grey



| | | |
|-------|-----------|-------|
| 1,0 | 40060-8 | 31,72 |
| 2,0 | 72848-1 | 63,44 |
| 2,7 * | 40070-7 * | 85,64 |

| | |
|-----------|-------|
| 40061-5 | 33,68 |
| 72850-4 | 67,34 |
| 40071-4 * | 91,50 |



Emaillbeschichtung
 Farbton - silber metallic

stainless steel-enameled, colour - silver metallic



| | | |
|-------|-----------|--------|
| 1,0 | 40210-7 | 41,00 |
| 2,0 | 72852-8 | 81,98 |
| 2,7 * | 40211-4 * | 110,22 |

| | |
|-----------|--------|
| 40212-1 | 42,94 |
| 72854-2 | 85,90 |
| 40213-8 * | 116,08 |



Edelst.-Emaillbeschichtung
 mit 4 nachleuchtenden Rillen
 Farbton - dunkelgrau

stainless steel-enameled with 4 photoluminescent grooves, colour - dark grey



| | | |
|-------|-----------|--------|
| 1,0 | 40065-3 | 57,42 |
| 2,0 | 72856-6 | 114,84 |
| 2,7 * | 40075-2 * | 155,04 |

| | |
|-----------|--------|
| 40067-7 | 59,38 |
| 72858-0 | 118,74 |
| 40077-6 * | 160,90 |

* Auslaufartikel / discontinued item

passende emaillierte Schrauben siehe Abschnitt 12/ suitable enameled screws see section 12

1. WINKELPROFILE + TREPPENKANTEN AUS ALUMINIUM + MESSING / 1. ANGLE EDGES + STAIR NOSINGS ALU + BRASS

Andere Eloxalfarben siehe
 Abschnitt 6, Lieferzeit 14 Tage/
 other anodized colours see
 section 6, delivery time 14 days

| Profi-Pack à 10 Stück im Bund | | | |
|--------------------------------|-----------|-----------|-------------|
| professional packing à 10 pcs. | | | |
| Farbe/colour | L / l (m) | Art./ref. | €/Stk./pcs. |

| SB-Pack incl. Schr./ Dübel; VE 20 Stk. | |
|---|-------------|
| self-service-pack with screws/ dowels; à 20 pcs. | |
| Art./ref. | €/Stk./pcs. |

372 Treppenkante 30 x 30 x 2 mm R, Aluminium eloxiert, gebohrt

stair nosing 30 x 30 x 2 mm R,
 aluminium anodized, drilled

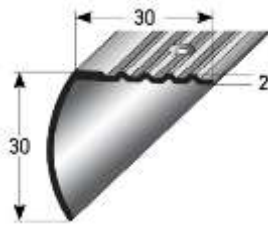

| | | | |
|--------------------------------|-----|---------|-------|
| silberfarbig silver | 1,0 | 66200-6 | 8,92 |
| | 2,7 | 66202-0 | 24,04 |
| goldfarbig gold | 1,0 | 66204-4 | 9,30 |
| | 2,7 | 66206-8 | 25,12 |
| bronzef. hell bronze light | 1,0 | 66208-2 | 10,26 |
| | 2,7 | 66210-5 | 27,76 |
| bronzef. dunkel bronze dark | 1,0 | 66212-9 | 10,74 |
| | 2,7 | 66214-3 | 29,04 |

| | |
|---------|-------|
| 66216-7 | 9,96 |
| 66218-1 | 27,16 |
| 66220-4 | 10,34 |
| 66222-8 | 28,24 |
| 66224-2 | 11,30 |
| 66226-6 | 30,88 |
| 66228-0 | 11,76 |
| 66230-3 | 32,16 |

342 Treppenkante 22 x 30 mm, Aluminium eloxiert, gebohrt

stair nosing 22 x 30 mm,
 aluminium anodized, drilled

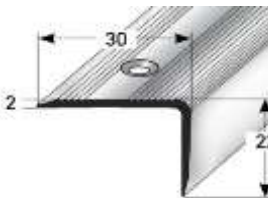

| | | | |
|--------------------------------|-----|---------|-------|
| silberfarbig silver | 1,0 | 65540-4 | 8,80 |
| | 2,7 | 65542-8 | 23,72 |
| goldfarbig gold | 1,0 | 65544-2 | 9,08 |
| | 2,7 | 65546-6 | 24,54 |
| bronzef. hell bronze light | 1,0 | 65548-0 | 10,24 |
| | 2,7 | 65550-3 | 27,72 |
| bronzef. dunkel bronze dark | 1,0 | 65552-7 | 10,24 |
| | 2,7 | 65554-1 | 27,72 |

| | |
|---------|-------|
| 65560-2 | 9,70 |
| 65562-6 | 26,50 |
| 65564-0 | 10,02 |
| 65566-4 | 27,36 |
| 65568-8 | 11,66 |
| 65570-1 | 31,92 |
| 65572-5 | 11,18 |
| 65574-9 | 30,52 |

388 Treppenkante 27 x 27 mm, Aluminium eloxiert, gebohrt

stair nosing 27 x 27 mm,
 aluminium anodized, drilled



| | | | |
|--------------------------------|-----|---------|-------|
| silberfarbig silver | 1,0 | 67196-1 | 9,12 |
| | 2,7 | 67198-5 | 24,70 |
| goldfarbig gold | 1,0 | 67200-5 | 9,46 |
| | 2,7 | 67202-9 | 25,54 |
| bronzef. hell bronze light | 1,0 | 67204-3 | 10,62 |
| | 2,7 | 67206-7 | 28,68 |
| bronzef. dunkel bronze dark | 1,0 | 67208-1 | 10,62 |
| | 2,7 | 67210-4 | 28,68 |

| | |
|---------|-------|
| 67216-6 | 9,56 |
| 67218-0 | 27,48 |
| 67220-3 | 10,40 |
| 67222-7 | 28,32 |
| 67224-1 | 12,04 |
| 67226-5 | 32,88 |
| 67228-9 | 11,56 |
| 67230-2 | 31,48 |

343 Treppenkante 32 x 30 mm, Aluminium eloxiert, gebohrt

stair nosing 32 x 30 mm,
 aluminium anodized, drilled

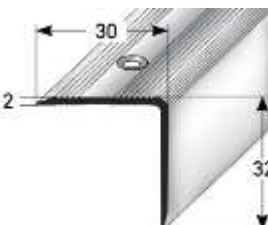

| | | | |
|--------------------------------|-----|---------|-------|
| silberfarbig silver | 1,0 | 65582-4 | 11,02 |
| | 2,7 | 65584-8 | 29,74 |
| goldfarbig gold | 1,0 | 65586-2 | 11,72 |
| | 2,7 | 65588-6 | 31,70 |
| bronzef. hell bronze light | 1,0 | 65590-9 | 13,24 |
| | 2,7 | 65592-3 | 35,74 |
| bronzef. dunkel bronze dark | 1,0 | 65594-7 | 13,24 |
| | 2,7 | 65596-1 | 35,74 |

| | |
|---------|-------|
| 65602-9 | 11,92 |
| 65604-3 | 32,52 |
| 65606-7 | 12,66 |
| 65608-1 | 34,50 |
| 65610-4 | 14,66 |
| 65612-8 | 39,96 |
| 65614-2 | 14,16 |
| 65616-6 | 38,56 |

1. WINKELPROFILE + TREPPENKANTEN AUS ALUMINIUM + MESSING / 1. ANGLE EDGES + STAIR NOSINGS ALU + BRASS

Andere Eloxalfarben siehe
 Abschnitt 6, Lieferzeit 14 Tage
 other anodized colours see
 section 6, delivery time 14 days

| Profi-Pack à 10 Stück im Bund | | | |
|--------------------------------|-----------|-----------|-------------|
| professional packing à 10 pcs. | | | |
| Farbe/colour | L / l (m) | Art./ref. | €/Stk./pcs. |

| SB-Pack incl. Schr./ Dübel; VE 20 Stk. | |
|---|-------------|
| self-service-pack with screws/ dowels; à 20 pcs. | |
| Art./ref. | €/Stk./pcs. |

344 Treppenkante 42 x 30 mm, Aluminium eloxiert, gebohrt

stair nosing 42 x 30 mm,
 aluminium anodized, drilled

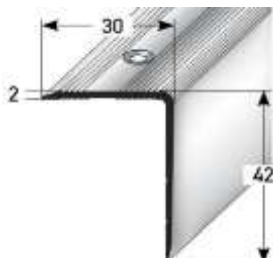

| | | | |
|--------------------------------|-----|---------|-------|
| silberfarbig silver | 1,0 | 65624-1 | 12,76 |
| | 2,7 | 65626-5 | 34,42 |
| goldfarbig gold | 1,0 | 65628-9 | 13,20 |
| | 2,7 | 65630-2 | 35,64 |
| bronzef. hell bronze light | 1,0 | 65632-6 | 14,26 |
| | 2,7 | 65634-0 | 38,50 |
| bronzef. dunkel bronze dark | 1,0 | 65636-4 | 14,26 |
| | 2,7 | 65638-8 | 38,50 |

| | |
|---------|-------|
| 65644-9 | 13,66 |
| 65646-3 | 37,24 |
| 65648-7 | 14,12 |
| 65650-0 | 38,46 |
| 65652-4 | 15,68 |
| 65654-8 | 42,72 |
| 65656-2 | 15,16 |
| 65658-6 | 41,30 |

389 Treppenkante 42 x 40 mm, Aluminium eloxiert, gebohrt

stair nosing 42 x 40 mm,
 aluminium anodized, drilled



| | | | |
|--------------------------------|-----|---------|-------|
| silberfarbig silver | 1,0 | 67152-7 | 14,50 |
| | 2,7 | 67154-1 | 39,12 |
| goldfarbig gold | 1,0 | 67156-5 | 15,02 |
| | 2,7 | 67158-9 | 40,54 |
| bronzef. hell bronze light | 1,0 | 67160-2 | 16,78 |
| | 2,7 | 67162-6 | 45,30 |
| bronzef. dunkel bronze dark | 1,0 | 67164-0 | 16,78 |
| | 2,7 | 67166-4 | 45,30 |

| | |
|---------|-------|
| 67172-5 | 15,40 |
| 67174-9 | 41,94 |
| 67176-3 | 15,92 |
| 67178-7 | 43,36 |
| 67180-0 | 18,16 |
| 67182-4 | 49,50 |
| 67184-8 | 17,68 |
| 67186-2 | 48,10 |

345 Treppenkante 52 x 30 mm, Aluminium eloxiert, gebohrt

stair nosing 52 x 30 mm,
 aluminium anodized, drilled



| | | | |
|--------------------------------|-----|---------|-------|
| silberfarbig silver | 1,0 | 65666-1 | 14,50 |
| | 2,7 | 65668-5 | 39,12 |
| goldfarbig gold | 1,0 | 65670-8 | 15,02 |
| | 2,7 | 65672-2 | 40,54 |
| bronzef. hell bronze light | 1,0 | 65674-6 | 16,78 |
| | 2,7 | 65676-0 | 45,30 |
| bronzef. dunkel bronze dark | 1,0 | 65678-4 | 16,78 |
| | 2,7 | 65680-7 | 45,30 |

| | |
|---------|-------|
| 65686-9 | 15,40 |
| 65688-3 | 41,94 |
| 65690-6 | 15,92 |
| 65692-0 | 43,36 |
| 65694-4 | 18,16 |
| 65696-8 | 49,50 |
| 65698-2 | 17,68 |
| 65700-2 | 48,10 |

1. WINKELPROFILE + TREPPENKANTEN AUS ALUMINIUM + MESSING / 1. ANGLE EDGES + STAIR NOSINGS ALU + BRASS

Andere Eloxalfarben siehe
 Abschnitt 6, Lieferzeit 14 Tage
 other anodized colours see
 section 6, delivery time 14 days

| Profi-Pack à 10 Stück im Bund | | | |
|--------------------------------|-----------|-----------|-------------|
| professional packing à 10 pcs. | | | |
| Farbe/colour | L / l (m) | Art./ref. | €/Stk./pcs. |

| SB-Pack incl. Schr./ Dübel; VE 20 Stk. | |
|---|-------------|
| self-service-pack with screws/ dowels; à 20 pcs. | |
| Art./ref. | €/Stk./pcs. |

9 5 Treppenkante 15 x 40 mm, Aluminium eloxiert, gebohrt

stair nosing 15 x 40 mm,
 aluminium anodized, drilled



| | | | |
|------------------------------------|-----|---------|-------|
| silberfarbig silver | 1,0 | 41100-0 | 13,24 |
| | 2,7 | 41110-9 | 35,82 |
| goldfarbig gold | 1,0 | 41120-8 | 13,76 |
| | 2,7 | 41130-7 | 37,08 |
| bronzef. hell bronze light | 1,0 | 41140-6 | 14,96 |
| | 2,7 | 41150-5 | 40,36 |
| bronzef. dunkel bronze dark | 1,0 | 41160-4 | 14,96 |
| | 2,7 | 41170-3 | 40,36 |
| Aluminium blank aluminium plain | 1,0 | 41180-2 | 10,76 |
| | 2,7 | 41190-1 | 29,18 |

| | |
|---------|-------|
| 41105-5 | 14,20 |
| 41115-4 | 38,36 |
| 41125-3 | 14,68 |
| 41135-2 | 39,64 |
| 41145-1 | 16,36 |
| 41155-0 | 44,14 |
| 41165-9 | 15,88 |
| 41175-8 | 42,92 |
| 41185-7 | 11,74 |
| 41195-6 | 31,76 |

8 7 Treppenkante 23 x 40 mm, Aluminium eloxiert, gebohrt

stair nosing 23 x 40 mm,
 aluminium anodized, drilled

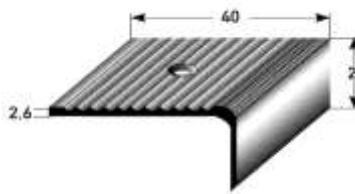

| | | | |
|--------------------------------|-----|---------|-------|
| silberfarbig silver | 0,9 | 29430-6 | 12,76 |
| | 1,0 | 29435-1 | 14,18 |
| | 2,7 | 29440-5 | 38,30 |
| goldfarbig gold | 0,9 | 29445-0 | 13,22 |
| | 1,0 | 29450-4 | 14,70 |
| | 2,7 | 29455-9 | 39,70 |
| bronzef. hell bronze light | 0,9 | 29460-3 | 14,46 |
| | 1,0 | 29465-8 | 16,08 |
| | 2,7 | 29470-2 | 43,40 |
| bronzef. dunkel bronze dark | 0,9 | 29475-7 | 14,46 |
| | 1,0 | 29480-1 | 16,08 |
| | 2,7 | 29485-6 | 43,40 |

| | |
|---------|-------|
| 29436-8 | 15,12 |
| 29441-2 | 40,90 |
| 29451-1 | 15,64 |
| 29456-6 | 42,30 |
| 29466-5 | 17,52 |
| 29471-9 | 47,30 |
| 29481-8 | 17,04 |
| 29486-3 | 46,00 |

Aluminium mit abriebfester Spezialmaillierung, gebohrt/ aluminium enameled, hard wearing, drilled



Edelst.-Emaillbeschichtung
 Farbton - dunkelgrau

stainless steel-enameled, colour - dark grey



| | | |
|-------|-----------|-------|
| 1,0 | 40080-6 | 36,90 |
| 2,0 | 72836-8 | 73,80 |
| 2,7 * | 40090-5 * | 99,64 |

| | |
|-----------|--------|
| 40081-3 | 38,86 |
| 72838-2 | 77,70 |
| 40091-2 * | 105,48 |



Emaillbeschichtung
 Farbton - silber metallic

stainless steel-enameled, colour - silver metallic



| | | |
|-------|-----------|--------|
| 1,0 | 40230-5 | 46,18 |
| 2,0 | 72840-5 | 92,36 |
| 2,7 * | 40231-2 * | 124,68 |

| | |
|-----------|--------|
| 40232-9 | 48,12 |
| 72842-9 | 96,26 |
| 40233-6 * | 130,54 |



Edelst.-Emaillbeschichtung mit
 5 nachleuchtenden Rillen
 Farbton - dunkelgrau

stainless steel-enameled with 5 photoluminescent grooves, colour - dark grey



| | | |
|-------|-----------|--------|
| 1,0 | 40085-1 | 62,60 |
| 2,0 | 72844-3 | 125,20 |
| 2,7 * | 40095-0 * | 169,04 |

| | |
|-----------|--------|
| 40087-5 | 64,56 |
| 72846-7 | 129,12 |
| 40097-4 * | 174,88 |

* Auslaufartikel / discontinued item

passende emaillierte Schrauben siehe Abschnitt 12/ suitable enameled screws see section 12

1. WINKELPROFILE + TREPPENKANTEN AUS ALUMINIUM + MESSING / 1. ANGLE EDGES + STAIR NOSINGS ALU + BRASS

Andere Eloxalfarben siehe Abschnitt 6, Lieferzeit 14 Tage
 other anodized colours see section 6, delivery time 14 days

| Profi-Pack à 10 Stück im Bund | | | |
|--------------------------------|-----------|-----------|-------------|
| professional packing à 10 pcs. | | | |
| Farbe/colour | L / l (m) | Art./ref. | €/Stk./pcs. |

| SB-Pack incl. Schr./ Dübel; VE 20 Stk. | |
|--|-------------|
| self-service-pack with screws/ dowels; à 20 pcs. | |
| Art./ref. | €/Stk./pcs. |

91 Treppenkante 20 x 40 mm, Aluminium eloxiert, gebohrt

stair nosing 20 x 40 mm, aluminium anodized, drilled

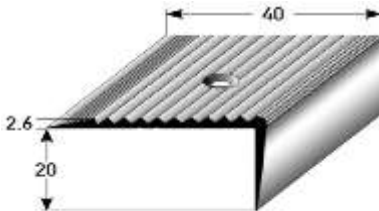

| | | | | | |
|------------------------------------|-----|---------|--------|---------|--------|
| silberfarbig silver | 0,8 | 07080-1 | 9,84 | | |
| | 0,9 | 07090-0 | 11,08 | 07091-7 | 11,94 |
| | 1,0 | 07100-6 | 12,30 | 07101-3 | 13,18 |
| | 1,2 | 07110-5 | 14,74 | 07111-2 | 15,80 |
| | 2,0 | 07120-4 | 24,58 | 07121-1 | 26,36 |
| | 2,7 | 07130-3 | 33,22 | 07131-0 | 35,84 |
| goldfarbig gold | 0,8 | 07180-8 | 12,10 | | |
| | 0,9 | 07190-7 | 13,58 | 07191-4 | 14,42 |
| | 1,0 | 07200-3 | 15,08 | 07201-0 | 16,04 |
| | 1,2 | 07210-2 | 18,10 | 07211-9 | 19,24 |
| | 2,0 | 07220-1 | 30,20 | 07221-8 | 32,14 |
| | 2,7 | 07230-0 | 40,76 | 07231-7 | 43,30 |
| bronzefarbig hell bronze light | 0,8 | 07280-5 | 13,18 | | |
| | 0,9 | 07290-4 | 14,84 | 07291-1 | 16,08 |
| | 1,0 | 07300-0 | 16,46 | 07301-7 | 17,88 |
| | 1,2 | 07310-9 | 19,80 | 07311-6 | 21,50 |
| | 2,0 | 07320-8 | 32,92 | 07321-5 | 35,82 |
| | 2,7 | 07330-7 | 44,50 | 07331-4 | 48,30 |
| bronzefarbig dunkel bronze dark | 0,8 | 07380-2 | 13,18 | | |
| | 0,9 | 07390-1 | 14,84 | 07391-8 | 15,68 |
| | 1,0 | 07400-7 | 16,46 | 07401-4 | 17,42 |
| | 1,2 | 07410-6 | 19,80 | 07411-3 | 20,90 |
| | 2,0 | 07420-5 | 32,92 | 07421-2 | 34,86 |
| | 2,7 | 07430-4 | 44,50 | 07431-1 | 47,04 |
| MESSING poliert brass polished | 1,0 | 28722-3 | 60,36 | 28723-0 | 61,52 |
| | 2,5 | 28720-9 | 150,90 | 28721-6 | 154,34 |

Bitte fordern Sie unsere Pflegehinweise für Messingprofile an!
 Please ask for our care tips for brass profiles!

97



Beispiel: Treppenkante mit abriebfester und nachleuchtender Spezialmaillierung (91) für bodennahe Leitsysteme nach BGR 216. Leuchtzeit: 1 Stunde stark bei einer Mindestbeleuchtung von 100 Lux für ca. 5 Min. (siehe nächste Seite)

example: stair nosing with abrasion-resistant and special luminescent enamel (91) for floor-level guidance systems according to BGR 216. Lighting time: 1 hour strong with a minimum illumination of 100 lux for approx. 5 min. (see next page)

1. WINKELPROFILE + TREPPENKANTEN AUS ALUMINIUM + MESSING / 1. ANGLE EDGES + STAIR NOSINGS ALU + BRASS

Andere Eloxalfarben siehe
Abschnitt 6, Lieferzeit 14 Tage
other anodized colours see
section 6, delivery time 14 days





| Profi-Pack à 10 Stück im Bund | | | |
|--------------------------------|-----------|-----------|-------------|
| professional packing à 10 pcs. | | | |
| Farbe/colour | L / l (m) | Art./ref. | €/Stk./pcs. |

| SB-Pack incl. Schr./ Dübel; VE 20 Stk. | |
|---|-------------|
| self-service-pack with screws/ dowels; à 20 pcs. | |
| Art./ref. | €/Stk./pcs. |

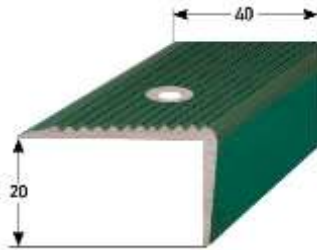
9 1 Treppenkante 20 x 40 mm, Aluminium mit abriebfester Spezialmaillierung, gebohrt

stair nosing 20 x 40 mm,
aluminium hard wearing enamel,
drilled



| | | | | | | |
|------------------------------------|---|-------|-----------|--------|-----------|--------|
| dunkelgrau dark grey |  | 1,0 | 40000-4 | 35,02 | 40001-1 | 36,96 |
| | | 2,0 | 72796-5 | 70,04 | 72798-9 | 73,94 |
| | | 2,7 * | 40010-3 * | 94,54 | 40011-0 * | 100,38 |
| silber metallic silver metallic |  | 1,0 | 40150-6 | 44,28 | 40152-0 | 46,24 |
| | | 2,0 | 72800-9 | 88,58 | 72802-3 | 92,48 |
| | | 2,7 * | 40151-3 * | 119,58 | 40153-7 * | 125,44 |
| gold gold | | 1,0 * | 64000-4 * | 42,78 | 64022-6 * | 44,72 |
| | | 2,7 * | 64002-8 * | 115,50 | 64024-0 * | 121,34 |
| blau blue |  | 1,0 | 64004-2 | 42,78 | 64026-4 | 44,72 |
| | | 2,0 | 72804-7 | 85,56 | 72806-1 | 89,46 |
| | | 2,7 * | 64006-6 * | 115,50 | 64028-8 * | 121,34 |
| rot red | | 1,0 * | 64008-0 * | 42,78 | 64030-1 * | 44,72 |
| | | 2,7 * | 64010-3 * | 115,50 | 64032-5 * | 121,34 |
| grün green |  | 1,0 | 64012-7 | 42,78 | 64034-9 | 44,72 |
| | | 2,0 | 72808-5 | 85,56 | 72810-8 | 89,46 |
| | | 2,7 * | 64014-1 * | 115,50 | 64036-3 * | 121,34 |
| schwarz black |  | 1,0 | 64016-5 | 42,78 | 64038-7 | 44,72 |
| | | 2,0 | 72812-2 | 85,56 | 72814-6 | 89,46 |
| | | 2,7 * | 64018-9 * | 115,50 | 64040-0 * | 121,34 |





* Auslaufartikel / discontinued item

9 1 Treppenkante 20 x 40 mm, Aluminium mit abriebfester Spezialmaillierung,

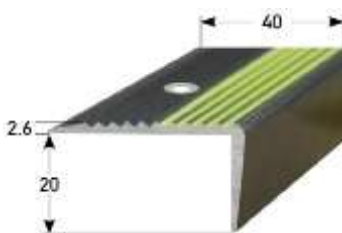
5 Rillen nachleuchtend, gebohrt

stair nosing 20 x 40 mm,
aluminium hard wearing enamel,
drilled, 5 photoluminescent
grooves



| | | | | | | |
|------------------------------------|---|-------|-----------|--------|-----------|--------|
| dunkelgrau dark grey |  | 1,0 | 40005-9 | 60,72 | 40007-3 | 62,66 |
| | | 2,0 | 72816-0 | 121,44 | 72818-4 | 125,34 |
| | | 2,7 * | 40015-8 * | 163,94 | 40017-2 * | 169,80 |
| silber metallic silver metallic |  | 1,0 | 40140-7 | 69,98 | 40144-5 | 71,94 |
| | | 2,0 | 72820-7 | 139,98 | 72822-1 | 143,88 |
| | | 2,7 * | 40142-1 * | 188,96 | 40146-9 * | 194,82 |
| gold gold | | 1,0 * | 64044-8 * | 68,48 | 64066-0 * | 70,42 |
| | | 2,7 * | 64046-2 * | 184,90 | 64068-4 * | 190,76 |
| blau blue |  | 1,0 | 64048-6 | 68,48 | 64070-7 | 70,42 |
| | | 2,0 | 72824-5 | 136,96 | 72826-9 | 140,86 |
| | | 2,7 * | 64050-9 * | 184,90 | 64072-1 * | 190,76 |
| rot red | | 1,0 * | 64052-3 * | 68,48 | 64074-5 * | 70,42 |
| | | 2,7 * | 64054-7 * | 184,90 | 64076-9 * | 190,76 |
| grün green |  | 1,0 | 64056-1 | 68,48 | 64078-3 | 70,42 |
| | | 2,0 | 72828-3 | 136,96 | 72830-6 | 140,86 |
| | | 2,7 * | 64058-5 * | 184,90 | 64080-6 * | 190,76 |
| schwarz black |  | 1,0 | 64060-8 | 68,48 | 64082-0 | 70,42 |
| | | 2,0 | 72832-0 | 136,96 | 72834-4 | 140,86 |
| | | 2,7 * | 64062-2 * | 184,90 | 64084-4 * | 190,76 |

* Auslaufartikel / discontinued item

1. WINKELPROFILE + TREPPENKANTEN AUS ALUMINIUM + MESSING / 1. ANGLE EDGES + STAIR NOSINGS ALU + BRASS

Andere Eloxalfarben siehe
Abschnitt 6, Lieferzeit 14 Tage
other anodized colours see
section 6, delivery time 14 days

| Profi-Pack à 10 Stück im Bund | | | |
|--------------------------------|-----------|-----------|-------------|
| professional packing à 10 pcs. | | | |
| Farbe/colour | L / l (m) | Art./ref. | €/Stk./pcs. |

| SB-Pack incl. Schr./ Dübel; VE 20 Stk. | |
|---|-------------|
| self-service-pack with screws/ dowels; à 20 pcs. | |
| Art./ref. | €/Stk./pcs. |

8 4 Treppenkante 28 x 50 mm, Aluminium eloxiert, gebohrt

stair nosing 28 x 50 mm,
aluminium anodized, drilled

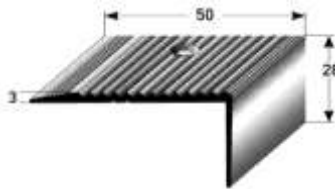

| | | | |
|--------------------------------|-----|---------|-------|
| silberfarbig silver | 1,0 | 31410-3 | 19,10 |
| | 2,7 | 31415-8 | 51,46 |
| goldfarbig gold | 1,0 | 31420-2 | 19,22 |
| | 2,7 | 31425-7 | 51,88 |
| bronzef. hell bronze light | 1,0 | 31430-1 | 22,46 |
| | 2,7 | 31435-6 | 60,76 |
| bronzef. dunkel bronze dark | 1,0 | 31440-0 | 22,46 |
| | 2,7 | 31445-5 | 60,76 |

| | |
|---------|-------|
| 31416-5 | 54,12 |
| 31426-4 | 54,44 |
| 31436-3 | 64,54 |
| 31446-2 | 63,28 |

Aluminium mit abriebfester Spezialmaillierung, gebohrt/ aluminium enameled, hard wearing, drilled



Edelstahl-Emaillbeschichtung
Farbton - dunkelgrau

stainless steel-enameled, colour - dark grey



| | | |
|-------|-----------|--------|
| 1,0 | 40040-0 | 41,82 |
| 2,0 | 72772-9 | 83,62 |
| 2,7 * | 40050-9 * | 112,90 |

| | |
|-----------|--------|
| 40041-7 | 43,76 |
| 72774-3 | 87,52 |
| 40051-6 * | 118,74 |



Emaillbeschichtung
Farbton - silber metallic

stainless steel-enameled, colour - silver metallic



| | | |
|-------|-----------|--------|
| 1,0 | 40190-2 | 51,08 |
| 2,0 | 72776-7 | 102,18 |
| 2,7 * | 40191-9 * | 137,94 |

| | |
|-----------|--------|
| 40192-6 | 53,04 |
| 72778-1 | 106,08 |
| 40193-3 * | 143,80 |



Edelstahl-Emaillbeschichtung
mit 5 nachleuchtenden Rillen
Farbton - dunkelgrau

stainless steel-enameled with 5 photoluminescent grooves, colour - dark grey



| | | |
|-------|-----------|--------|
| 1,0 | 40045-5 | 67,52 |
| 2,0 | 72780-4 | 135,02 |
| 2,7 * | 40055-4 * | 182,30 |

| | |
|-----------|--------|
| 40047-9 | 69,46 |
| 72782-8 | 138,92 |
| 40057-8 * | 188,14 |

* Auslaufartikel / discontinued item

passende emaillierte Schrauben siehe Abschnitt 12/ suitable enameled screws see section 12

8 3 Treppenkante 42 x 50 mm, Aluminium eloxiert, gebohrt

stair nosing 42 x 50 mm,
aluminium anodized, drilled

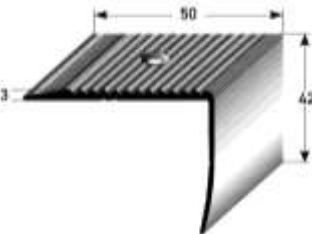

| | | | |
|--------------------------------|-----|---------|-------|
| silberfarbig silver | 1,0 | 07621-6 | 16,42 |
| | 2,5 | 07620-9 | 41,08 |
| goldfarbig gold | 1,0 | 07641-4 | 23,10 |
| | 2,5 | 07640-7 | 57,74 |
| bronzef. hell bronze light | 1,0 | 07661-2 | 27,00 |
| | 2,5 | 07660-5 | 67,62 |
| bronzef. dunkel bronze dark | 1,0 | 07681-0 | 27,00 |
| | 2,5 | 07680-3 | 67,62 |

| | |
|---------|-------|
| 07622-3 | 43,56 |
| 07642-1 | 60,28 |
| 07662-9 | 71,40 |
| 07682-7 | 70,18 |

Aluminium mit abriebfester Spezialmaillierung, gebohrt/ aluminium enameled, hard wearing, drilled



Edelstahl-Emaillbeschichtung
Farbton - dunkelgrau

stainless steel-enameled, colour - dark grey



| | | |
|-------|-----------|-------|
| 1,0 | 40020-2 | 39,14 |
| 2,0 | 72784-2 | 78,30 |
| 2,5 * | 40030-1 * | 97,88 |

| | |
|-----------|--------|
| 40021-9 | 41,10 |
| 72786-6 | 82,20 |
| 40031-8 * | 103,72 |



Emaillbeschichtung
Farbton - silber metallic

stainless steel-enameled, colour - silver metallic



| | | |
|-------|-----------|--------|
| 1,0 | 40170-4 | 48,42 |
| 2,0 | 72788-0 | 96,84 |
| 2,5 * | 40171-1 * | 121,06 |

| | |
|-----------|--------|
| 40172-8 | 50,38 |
| 72790-3 | 100,74 |
| 40173-5 * | 126,90 |



Edelstahl-Emaillbeschichtung
mit 5 nachleuchtenden Rillen
Farbton - dunkelgrau

stainless steel-enameled with 5 photoluminescent grooves, colour - dark grey



| | | |
|-------|-----------|--------|
| 1,0 | 40025-7 | 64,84 |
| 2,0 | 72792-7 | 129,70 |
| 2,5 * | 40035-6 * | 162,14 |

| | |
|-----------|--------|
| 40027-1 | 66,80 |
| 72794-1 | 133,60 |
| 40037-0 * | 167,98 |

* Auslaufartikel / discontinued item

passende emaillierte Schrauben siehe Abschnitt 12/ suitable enameled screws see section 12

1. WINKELPROFILE + TREPPENKANTEN AUS ALUMINIUM + MESSING / 1. ANGLE EDGES + STAIR NOSINGS ALU + BRASS

Andere Eloxfarben siehe
Abschnitt 6, Lieferzeit 14 Tage
other anodized colours see section 6,
delivery time 14 days

| Profi-Pack à 5 Stück im Bund | | | |
|-------------------------------|-----------|-----------|-------------|
| professional packing à 5 pcs. | | | |
| Farbe/colour | L / l (m) | Art./ref. | €/Stk./pcs. |

339 Treppenkante 55 x 69 mm, Aluminium eloxiert, gebohrt

stair nosing 55 x 69 mm, aluminium anodized, drilled

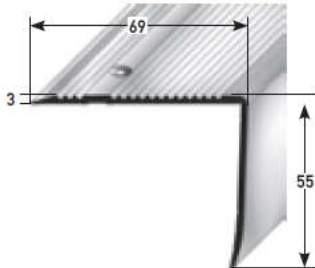

| | | | |
|--------------------------------|-----|---------|-------|
| silberfarbig silver | 1,0 | 65504-6 | 23,14 |
| | 2,7 | 65506-0 | 62,44 |
| goldfarbig gold | 1,0 | 65508-4 | 23,96 |
| | 2,7 | 65510-7 | 64,72 |
| bronzef. hell bronze light | 1,0 | 65512-1 | 26,84 |
| | 2,7 | 65514-5 | 72,44 |
| bronzef. dunkel bronze dark | 1,0 | 65516-9 | 26,84 |
| | 2,7 | 65518-3 | 72,44 |

passende Schrauben
siehe Abschnitt 12
suitable screws see
section 12

| Profi-Pack à 10 Stück im Bund | | | |
|--------------------------------|-----------|-----------|-------------|
| professional packing à 10 pcs. | | | |
| Farbe/colour | L / l (m) | Art./ref. | €/Stk./pcs. |

| SB-Pack incl. Schr./ Dübel; VE 20 Stk. | |
|---|-------------|
| self-service-pack with screws/ dowels; à 20 pcs. | |
| Art./ref. | €/Stk./pcs. |

127 Vorstoßprofil 2 x 25 mm, gebohrt

edge profile 2 x 25 mm,
drilled



| | | | |
|-----------------------------------|-----|---------|-------|
| Alu silberfarbig silver | 1,0 | 69960-6 | 6,00 |
| | 2,5 | 69962-0 | 14,98 |
| Alu goldfarbig gold | 1,0 | 69964-4 | 6,22 |
| | 2,5 | 69966-8 | 15,54 |
| Alu bronze hell bronze light | 1,0 | 69968-2 | 7,60 |
| | 2,5 | 69970-5 | 19,02 |
| Alu bronze dunkel bronze dark | 1,0 | 69972-9 | 7,60 |
| | 2,5 | 69974-3 | 19,02 |
| MESSING poliert brass polished | 1,0 | 28210-5 | 30,98 |
| | 2,0 | 28220-4 | 61,98 |
| | 2,5 | 28200-6 | 77,46 |

| | |
|---------|-------|
| 69978-1 | 6,92 |
| 69980-4 | 17,72 |
| 69982-8 | 7,14 |
| 69984-2 | 18,30 |
| 69986-6 | 8,52 |
| 69988-0 | 21,90 |
| 69990-3 | 8,52 |
| 69992-7 | 21,90 |
| 28211-2 | 32,36 |
| 28201-3 | 80,90 |

Bitte fordern Sie unsere Pflegehinweise für Messingprofile an!
Please ask for our care tips for brass profiles!

129 Vorstoßprofil 3 x 30 mm, gebohrt

edge profile 3 x 30 mm,
drilled



| | | | |
|-----------------------------------|-----|---------|-------|
| MESSING poliert brass polished | 1,0 | 28630-1 | 34,10 |
| | 2,0 | 28640-0 | 68,18 |
| | 2,5 | 28650-9 | 85,24 |

| | |
|---------|-------|
| 28631-8 | 35,48 |
| 28651-6 | 88,78 |

Bitte fordern Sie unsere Pflegehinweise für Messingprofile an!
Please ask for our care tips for brass profiles!

128 Vorstoßprofil 3 x 35 mm, gebohrt

edge profile 3 x 35 mm,
drilled

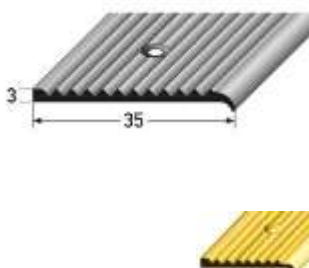

| | | | |
|-----------------------------------|-----|---------|--------|
| Alu silberfarbig silver | 1,0 | 28530-4 | 10,30 |
| | 2,5 | 28535-9 | 25,78 |
| Alu goldfarbig gold | 1,0 | 28540-3 | 10,64 |
| | 2,5 | 28545-8 | 26,66 |
| Alu bronze hell bronze light | 1,0 | 28550-2 | 12,28 |
| | 2,5 | 28555-7 | 30,70 |
| Alu bronze dunkel bronze dark | 1,0 | 28560-1 | 12,28 |
| | 2,5 | 28565-6 | 30,70 |
| MESSING poliert brass polished | 1,0 | 28610-3 | 43,56 |
| | 2,0 | 28620-2 | 87,10 |
| | 2,5 | 28600-4 | 108,90 |

| | |
|---------|--------|
| 28531-1 | 11,30 |
| 28536-6 | 28,30 |
| 28541-0 | 11,68 |
| 28546-5 | 29,24 |
| 28551-9 | 13,82 |
| 28556-4 | 34,48 |
| 28561-8 | 13,32 |
| 28566-3 | 33,30 |
| 28611-0 | 44,90 |
| 28601-1 | 112,36 |

Bitte fordern Sie unsere Pflegehinweise für Messingprofile an!
Please ask for our care tips for brass profiles!

1. WINKELPROFILE + TREPPENKANTEN AUS ALUMINIUM + MESSING / 1. ANGLE EDGES + STAIR NOSINGS ALU + BRASS

Andere Eloxalfarben siehe
Abschnitt 6, Lieferzeit 14 Tage
other anodized colours see section 6,
delivery time 14 days

| Profi-Pack à 10 Stück im Bund | | | |
|--------------------------------|-----------|-----------|-------------|
| professional packing à 10 pcs. | | | |
| Farbe/colour | L / l (m) | Art./ref. | €/Stk./pcs. |

| SB-Pack incl. Schr./ Dübel; VE 20 Stk. | |
|---|-------------|
| self-service-pack with screws/ dowels; à 20 pcs. | |
| Art./ref. | €/Stk./pcs. |

474 Fassonprofil 2 mm, Aluminium eloxiert, gebohrt

fasson stair nosing 2 mm,
aluminium anodized, drilled



| | | | | | |
|--------------------------------|-----|---------|-------|---------|---------|
| silberfarbig silver | 1,0 | 70700-4 | 5,86 | 70716-5 | 6,78 |
| | 2,7 | 70702-8 | 15,78 | | 70718-9 |
| goldfarbig gold | 1,0 | 70704-2 | 6,16 | 70720-2 | 7,12 |
| | 2,7 | 70706-6 | 16,64 | 70722-6 | 19,22 |
| bronzef. hell bronze light | 1,0 | 70708-0 | 6,74 | 70724-0 | 8,12 |
| | 2,7 | 70710-3 | 18,16 | 70726-4 | 21,94 |
| bronzef. dunkel bronze dark | 1,0 | 70712-7 | 6,74 | 70728-8 | 7,70 |
| | 2,7 | 70714-1 | 18,16 | 70730-1 | 21,94 |

| | |
|---------|-------|
| 70716-5 | 6,78 |
| 70718-9 | 18,42 |
| 70720-2 | 7,12 |
| 70722-6 | 19,22 |
| 70724-0 | 8,12 |
| 70726-4 | 21,94 |
| 70728-8 | 7,70 |
| 70730-1 | 21,94 |

475 Fassonprofil 2,5 mm, Aluminium eloxiert, gebohrt

fasson stair nosing 2,5 mm,
aluminium anodized, drilled



| | | | | | |
|--------------------------------|-----|---------|-------|---------|---------|
| silberfarbig silver | 1,0 | 70734-9 | 5,88 | 70750-9 | 6,80 |
| | 2,7 | 70736-3 | 15,84 | | 70752-3 |
| goldfarbig gold | 1,0 | 70738-7 | 6,22 | 70754-7 | 7,16 |
| | 2,7 | 70740-0 | 16,78 | 70756-1 | 19,36 |
| bronzef. hell bronze light | 1,0 | 70742-4 | 6,78 | 70758-5 | 8,16 |
| | 2,7 | 70744-8 | 18,32 | 70760-8 | 22,12 |
| bronzef. dunkel bronze dark | 1,0 | 70746-2 | 6,78 | 70762-2 | 7,74 |
| | 2,7 | 70748-6 | 18,32 | 70764-6 | 22,12 |

| | |
|---------|-------|
| 70750-9 | 6,80 |
| 70752-3 | 18,50 |
| 70754-7 | 7,16 |
| 70756-1 | 19,36 |
| 70758-5 | 8,16 |
| 70760-8 | 22,12 |
| 70762-2 | 7,74 |
| 70764-6 | 22,12 |

476 Fassonprofil 3 mm, Aluminium eloxiert, gebohrt

fasson stair nosing 3 mm,
aluminium anodized, drilled



| | | | | | |
|--------------------------------|-----|---------|-------|---------|---------|
| silberfarbig silver | 1,0 | 70768-4 | 5,92 | 70784-4 | 6,86 |
| | 2,7 | 70770-7 | 15,98 | | 70786-8 |
| goldfarbig gold | 1,0 | 70772-1 | 6,26 | 70788-2 | 7,20 |
| | 2,7 | 70774-5 | 16,90 | 70790-5 | 19,50 |
| bronzef. hell bronze light | 1,0 | 70776-9 | 6,84 | 70792-9 | 8,22 |
| | 2,7 | 70778-3 | 18,46 | 70794-3 | 22,24 |
| bronzef. dunkel bronze dark | 1,0 | 70780-6 | 6,84 | 70796-7 | 7,78 |
| | 2,7 | 70782-0 | 18,46 | 70798-1 | 22,24 |

| | |
|---------|-------|
| 70784-4 | 6,86 |
| 70786-8 | 18,64 |
| 70788-2 | 7,20 |
| 70790-5 | 19,50 |
| 70792-9 | 8,22 |
| 70794-3 | 22,24 |
| 70796-7 | 7,78 |
| 70798-1 | 22,24 |



| |
|---|
| Befestigungsschenkel ausklinken attachment flanges notched |
| Befestigungsschenkel ausklinken und biegen attachment flanges notched and bent |

| Art./ref. | €/m |
|---------------------------|------|
| 22240-8 | 6,76 |
| auf Anfrage on request | |

1. WINKELPROFILE + TREPPENKANTEN AUS ALUMINIUM + MESSING / 1. ANGLE EDGES + STAIR NOSINGS ALU + BRASS

Andere Eloxalfarben siehe
 Abschnitt 6, Lieferzeit 14 Tage
 other anodized colours see
 section 6, delivery time 14 days

| Profi-Pack à 10 Stück im Bund | | | |
|--------------------------------|-----------|-----------|-------------|
| professional packing à 10 pcs. | | | |
| Farbe/colour | L / l (m) | Art./ref. | €/Stk./pcs. |

| SB-Pack incl. Schr./ Dübel; VE 20 Stk. | |
|---|-------------|
| self-service-pack with screws/ dowels; à 20 pcs. | |
| Art./ref. | €/Stk./pcs. |

435 Treppenkante 10 x 37 x 2 mm, Aluminium eloxiert, gebohrt

stair nosing 10 x 37 x 2 mm,
 aluminium anodized, drilled



| | | | |
|--------------------------------|-----|---------|-------|
| silberfarbig silver | 1,0 | 68100-7 | 10,76 |
| | 2,7 | 68102-1 | 29,10 |
| goldfarbig gold | 1,0 | 68104-5 | 11,40 |
| | 2,7 | 68106-9 | 30,76 |
| bronzef. hell bronze light | 1,0 | 68108-3 | 12,82 |
| | 2,7 | 68110-6 | 34,66 |
| bronzef. dunkel bronze dark | 1,0 | 68112-0 | 12,82 |
| | 2,7 | 68114-4 | 34,66 |

| | |
|---------|-------|
| 68118-2 | 11,72 |
| 68120-5 | 31,98 |
| 68122-9 | 12,34 |
| 68124-3 | 33,66 |
| 68126-7 | 13,78 |
| 68128-1 | 37,54 |
| 68130-4 | 13,78 |
| 68132-8 | 37,54 |

436 Treppenkante 24 x 37 x 2 mm, Aluminium eloxiert, gebohrt

stair nosing 24 x 37 x 2 mm,
 aluminium anodized, drilled

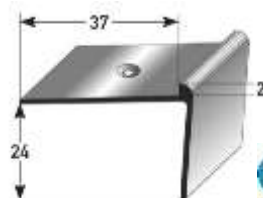

| | | | |
|--------------------------------|-----|---------|-------|
| silberfarbig silver | 1,0 | 68150-2 | 11,58 |
| | 2,7 | 68152-6 | 31,30 |
| goldfarbig gold | 1,0 | 68154-0 | 12,18 |
| | 2,7 | 68156-4 | 32,88 |
| bronzef. hell bronze light | 1,0 | 68158-8 | 13,70 |
| | 2,7 | 68160-1 | 36,96 |
| bronzef. dunkel bronze dark | 1,0 | 68162-5 | 13,70 |
| | 2,7 | 68164-9 | 36,96 |

| | |
|---------|-------|
| 68168-7 | 12,56 |
| 68170-0 | 34,20 |
| 68172-4 | 13,16 |
| 68174-8 | 35,80 |
| 68176-2 | 14,66 |
| 68178-6 | 39,86 |
| 68180-9 | 14,66 |
| 68182-3 | 39,86 |

266 Treppenkante 40 x 37 x 2 mm, Aluminium eloxiert, gebohrt

stair nosing 40 x 37 x 2 mm,
 aluminium anodized, drilled



| | | | |
|--------------------------------|-----|---------|-------|
| silberfarbig silver | 1,0 | 46482-2 | 12,72 |
| | 2,7 | 46480-8 | 34,38 |
| goldfarbig gold | 1,0 | 46492-1 | 13,24 |
| | 2,7 | 46490-7 | 35,84 |
| bronzef. hell bronze light | 1,0 | 46502-7 | 15,04 |
| | 2,7 | 46500-3 | 40,58 |
| bronzef. dunkel bronze dark | 1,0 | 46512-6 | 15,04 |
| | 2,7 | 46510-2 | 40,58 |

| | |
|---------|-------|
| 46486-0 | 13,70 |
| 46484-6 | 37,24 |
| 46496-9 | 14,20 |
| 46494-5 | 38,68 |
| 46506-5 | 15,98 |
| 46504-1 | 43,42 |
| 46516-4 | 15,98 |
| 46514-0 | 43,42 |

383 Treppenkante 10 x 37 x 2,5 mm, Aluminium eloxiert, gebohrt

stair nosing 10 x 37 x 2,5 mm,
 aluminium anodized, drilled

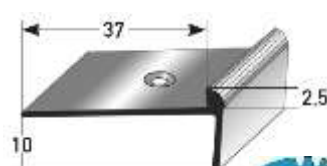

| | | | |
|--------------------------------|-----|---------|-------|
| silberfarbig silver | 1,0 | 66556-4 | 11,36 |
| | 2,7 | 66558-8 | 30,74 |
| goldfarbig gold | 1,0 | 66560-1 | 12,00 |
| | 2,7 | 66562-5 | 32,34 |
| bronzef. hell bronze light | 1,0 | 66564-9 | 13,40 |
| | 2,7 | 66566-3 | 36,20 |
| bronzef. dunkel bronze dark | 1,0 | 66568-7 | 13,40 |
| | 2,7 | 66570-0 | 36,20 |

| | |
|---------|-------|
| 66580-9 | 12,32 |
| 66582-3 | 33,58 |
| 66584-7 | 12,94 |
| 66586-1 | 35,22 |
| 66588-5 | 14,36 |
| 66590-8 | 39,06 |
| 66592-2 | 14,36 |
| 66594-6 | 39,06 |



| |
|---|
| Befestigungsschenkel ausklinken attachment flanges notched |
| Befestigungsschenkel ausklinken und biegen attachment flanges notched and bent |

| | |
|---------------------------|------|
| Art./ref. | €/m |
| 22240-8 | 6,76 |
| auf Anfrage on request | |

1. WINKELPROFILE + TREPPENKANTEN AUS ALUMINIUM + MESSING / 1. ANGLE EDGES + STAIR NOSINGS ALU + BRASS

Andere Eloxalfarben siehe
Abschnitt 6, Lieferzeit 14 Tage
other anodized colours see section 6,
delivery time 14 days

| Profi-Pack à 10 Stück im Bund | | | |
|--------------------------------|-----------|-----------|-------------|
| professional packing à 10 pcs. | | | |
| Farbe/colour | L / l (m) | Art./ref. | €/Stk./pcs. |

| SB-Pack incl. Schr./ Dübel; VE 20 Stk. | |
|---|-------------|
| self-service-pack with screws/ dowels; à 20 pcs. | |
| Art./ref. | €/Stk./pcs. |

384 Treppenkante 24 x 37 x 2,5 mm, Aluminium eloxiert, gebohrt

stair nosing 24 x 37 x 2,5 mm,
aluminium anodized, drilled



| | | | | | |
|--------------------------------|-----|---------|-------|---------|-------|
| silberfarbig silver | 1,0 | 66604-2 | 11,68 | 66628-8 | 12,66 |
| | 2,7 | 66606-6 | 31,56 | | |
| goldfarbig gold | 1,0 | 66608-0 | 12,28 | 66630-1 | 34,42 |
| | 2,7 | 66610-3 | 33,20 | | |
| bronzef. hell bronze light | 1,0 | 66612-7 | 13,76 | 66632-5 | 13,24 |
| | 2,7 | 66614-1 | 37,18 | | |
| bronzef. dunkel bronze dark | 1,0 | 66616-5 | 13,76 | 66634-9 | 36,04 |
| | 2,7 | 66618-9 | 37,18 | | |

| | |
|---------|-------|
| 66636-3 | 14,72 |
| | |
| 66640-0 | 14,72 |
| | |

385 Treppenkante 40 x 37 x 2,5 mm, Aluminium eloxiert, gebohrt

stair nosing 40 x 37 x 2,5 mm,
aluminium anodized, drilled



| | | | | | |
|--------------------------------|-----|---------|-------|---------|-------|
| silberfarbig silver | 1,0 | 66652-3 | 12,80 | 66676-9 | 13,76 |
| | 2,7 | 66654-7 | 34,78 | | |
| goldfarbig gold | 1,0 | 66656-1 | 13,28 | 66678-3 | 37,68 |
| | 2,7 | 66658-5 | 35,90 | | |
| bronzef. hell bronze light | 1,0 | 66660-8 | 15,82 | 66680-6 | 14,26 |
| | 2,7 | 66662-2 | 42,72 | | |
| bronzef. dunkel bronze dark | 1,0 | 66664-6 | 15,82 | 66682-0 | 38,78 |
| | 2,7 | 66666-0 | 42,72 | | |

| | |
|---------|-------|
| 66684-4 | 16,78 |
| | |
| 66688-2 | 16,78 |
| | |

437 Treppenkante 10 x 37 x 3 mm, Aluminium eloxiert, gebohrt

stair nosing 10 x 37 x 3 mm,
aluminium anodized, drilled



| | | | | | |
|--------------------------------|-----|---------|-------|---------|-------|
| silberfarbig silver | 1,0 | 68200-4 | 10,98 | 68218-9 | 11,94 |
| | 2,7 | 68202-8 | 29,62 | | |
| goldfarbig gold | 1,0 | 68204-2 | 11,58 | 68220-2 | 32,50 |
| | 2,7 | 68206-6 | 31,30 | | |
| bronzef. hell bronze light | 1,0 | 68208-0 | 12,98 | 68222-6 | 12,56 |
| | 2,7 | 68210-3 | 35,04 | | |
| bronzef. dunkel bronze dark | 1,0 | 68212-7 | 12,98 | 68224-0 | 34,20 |
| | 2,7 | 68214-1 | 35,04 | | |

| | |
|---------|-------|
| 68226-4 | 13,96 |
| | |
| 68230-1 | 13,96 |
| | |

9 4 Treppenkante 24 x 37 x 3 mm, Aluminium eloxiert, gebohrt

stair nosing 24 x 37 x 3 mm,
aluminium anodized, drilled



| | | | | | |
|--------------------------------|-----|---------|-------|---------|-------|
| silberfarbig silver | 1,0 | 35560-1 | 11,76 | 35561-8 | 12,76 |
| | 2,7 | 35520-5 | 31,88 | | |
| goldfarbig gold | 1,0 | 35570-0 | 12,40 | 35521-2 | 34,48 |
| | 2,7 | 35530-4 | 33,44 | | |
| bronzef. hell bronze light | 1,0 | 35580-9 | 13,82 | 35571-7 | 13,28 |
| | 2,7 | 35540-3 | 37,26 | | |
| bronzef. dunkel bronze dark | 1,0 | 35590-8 | 13,82 | 35531-1 | 36,04 |
| | 2,7 | 35550-2 | 37,26 | | |

| | |
|---------|-------|
| 35581-6 | 14,74 |
| | |
| 35591-5 | 14,74 |
| | |



| | |
|---|--|
| Befestigungsschenkel ausklinken attachment flanges notched | |
| Befestigungsschenkel ausklinken und biegen attachment flanges notched and bent | |

| | |
|---------------------------|------|
| Art./ref. | €/m |
| 22240-8 | 6,76 |
| auf Anfrage on request | |

1. WINKELPROFILE + TREPPENKANTEN AUS ALUMINIUM + MESSING / 1. ANGLE EDGES + STAIR NOSINGS ALU + BRASS

Andere Eloxalfarben siehe
 Abschnitt 6, Lieferzeit 14 Tage
 other anodized colours see
 section 6, delivery time 14 days

| Profi-Pack à 10 Stück im Bund | | | |
|--------------------------------|-----------|-----------|-------------|
| professional packing à 10 pcs. | | | |
| Farbe/colour | L / l (m) | Art./ref. | €/Stk./pcs. |

| SB-Pack incl. Schr./ Dübel; VE 20 Stk. | |
|---|-------------|
| self-service-pack with screws/ dowels; à 20 pcs. | |
| Art./ref. | €/Stk./pcs. |

341 Treppenkante 40 x 40 x 3 mm, Aluminium eloxiert, gebohrt

stair nosing 40 x 40 x 3 mm,
 aluminium anodized, drilled



| | | | | | |
|--------------------------------|-----|---------|-------|---------|-------|
| silberfarbig silver | 1,0 | 65750-7 | 12,84 | 65770-5 | 13,76 |
| | 2,7 | 65752-1 | 34,74 | | |
| goldfarbig gold | 1,0 | 65754-5 | 13,36 | 65772-9 | 37,44 |
| | 2,7 | 65756-9 | 36,10 | | |
| bronzef. hell bronze light | 1,0 | 65758-3 | 15,92 | 65774-3 | 14,28 |
| | 2,7 | 65760-6 | 42,98 | | |
| bronzef. dunkel bronze dark | 1,0 | 65762-0 | 15,92 | 65776-7 | 38,86 |
| | 2,7 | 65764-4 | 42,98 | | |

| | |
|---------|-------|
| 65778-1 | 16,82 |
| 65780-4 | 45,70 |
| 65782-8 | 16,82 |
| 65784-2 | 45,70 |

537 Treppenkante 80 x 50 x 3 mm, Aluminium eloxiert, gebohrt

stair nosing 80 x 50 x 3 mm,
 aluminium anodized, drilled



| | | | | | |
|--------------------------------|-----|---------|-------|---------|-------|
| silberfarbig silver | 1,0 | 72862-7 | 19,38 | 72878-8 | 20,28 |
| | 2,7 | 72864-1 | 52,32 | | |
| goldfarbig gold | 1,0 | 72866-5 | 20,38 | 72880-1 | 55,02 |
| | 2,7 | 72868-9 | 55,02 | | |
| bronzef. hell bronze light | 1,0 | 72870-2 | 22,74 | 72882-5 | 21,28 |
| | 2,7 | 72872-6 | 61,40 | | |
| bronzef. dunkel bronze dark | 1,0 | 72874-0 | 22,74 | 72884-9 | 57,72 |
| | 2,7 | 72876-4 | 61,40 | | |

| | |
|---------|-------|
| 72886-3 | 23,64 |
| 72888-7 | 64,10 |
| 72890-0 | 23,64 |
| 72892-4 | 64,10 |



334 Treppenkante 10 x 37 x 5 mm, Aluminium eloxiert, gebohrt

stair nosing 10 x 37 x 5 mm,
 aluminium anodized, drilled

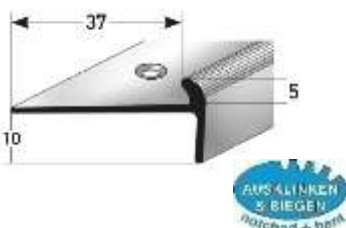

| | | | | | |
|--------------------------------|-----|---------|-------|---------|-------|
| silberfarbig silver | 1,0 | 65350-9 | 11,86 | 65354-7 | 12,80 |
| | 2,7 | 65352-3 | 32,10 | | |
| goldfarbig gold | 1,0 | 65360-8 | 12,48 | 65356-1 | 34,92 |
| | 2,7 | 65362-2 | 33,68 | | |
| bronzef. hell bronze light | 1,0 | 65370-7 | 13,88 | 65364-6 | 13,40 |
| | 2,7 | 65372-1 | 37,52 | | |
| bronzef. dunkel bronze dark | 1,0 | 65380-6 | 13,88 | 65366-0 | 36,48 |
| | 2,7 | 65382-0 | 37,52 | | |

| | |
|---------|-------|
| 65374-5 | 14,84 |
| 65376-9 | 40,34 |
| 65384-4 | 14,84 |
| 65386-8 | 40,34 |



| | | |
|---|---------------------------|------|
| Befestigungsschenkel ausklinken attachment flanges notched | Art./ref. | €/m |
| Befestigungsschenkel ausklinken und biegen attachment flanges notched and bent | 22240-8 | 6,76 |
| | auf Anfrage on request | |

1. WINKELPROFILE + TREPPENKANTEN AUS ALUMINIUM + MESSING / 1. ANGLE EDGES + STAIR NOSINGS ALU + BRASS

Andere Eloxalfarben siehe
Abschnitt 6, Lieferzeit 14 Tage
other anodized colours see
section 6, delivery time 14 days

| Profi-Pack à 10 Stück im Bund | | | |
|--------------------------------|-----------|-----------|-------------|
| professional packing à 10 pcs. | | | |
| Farbe/colour | L / l (m) | Art./ref. | €/Stk./pcs. |

| SB-Pack incl. Schr./ Dübel; VE 20 Stk. | |
|---|-------------|
| self-service-pack with screws/ dowels; à 20 pcs. | |
| Art./ref. | €/Stk./pcs. |

267 Treppenkante 24 x 37 x 5 mm, Aluminium eloxiert, gebohrt

stair nosing 24 x 37 x 5 mm,
aluminium anodized, drilled

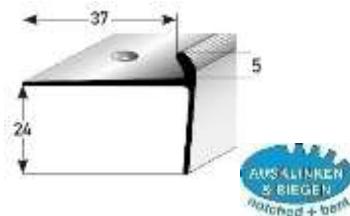

| | | | |
|--------------------------------|-----|---------|-------|
| silberfarbig silver | 1,0 | 46522-5 | 12,02 |
| | 2,7 | 46520-1 | 32,40 |
| goldfarbig gold | 1,0 | 46532-4 | 12,60 |
| | 2,7 | 46530-0 | 34,00 |
| bronzef. hell bronze light | 1,0 | 46542-3 | 14,02 |
| | 2,7 | 46540-9 | 37,88 |
| bronzef. dunkel bronze dark | 1,0 | 46552-2 | 14,02 |
| | 2,7 | 46550-8 | 37,88 |

| | |
|---------|-------|
| 46526-3 | 12,96 |
| 46524-9 | 35,24 |
| 46536-2 | 13,56 |
| 46534-8 | 36,88 |
| 46546-1 | 14,98 |
| 46544-7 | 40,76 |
| 46556-0 | 14,98 |
| 46554-6 | 40,76 |

340 Treppenkante 40 x 40 x 5 mm, Aluminium eloxiert, gebohrt

stair nosing 40 x 40 x 5 mm,
aluminium anodized, drilled



| | | | |
|--------------------------------|-----|---------|-------|
| silberfarbig silver | 1,0 | 65708-8 | 13,18 |
| | 2,7 | 65710-1 | 35,54 |
| goldfarbig gold | 1,0 | 65712-5 | 13,72 |
| | 2,7 | 65714-9 | 37,02 |
| bronzef. hell bronze light | 1,0 | 65716-3 | 16,30 |
| | 2,7 | 65718-7 | 44,04 |
| bronzef. dunkel bronze dark | 1,0 | 65720-0 | 16,30 |
| | 2,7 | 65722-4 | 44,04 |

| | |
|---------|-------|
| 65728-6 | 14,10 |
| 65730-9 | 38,28 |
| 65732-3 | 14,64 |
| 65734-7 | 39,78 |
| 65736-1 | 17,20 |
| 65738-5 | 46,78 |
| 65740-8 | 17,20 |
| 65742-2 | 46,78 |

333 Treppenkante 10 x 37 x 7 mm, Aluminium eloxiert, gebohrt

stair nosing 10 x 37 x 7 mm,
aluminium anodized, drilled



| | | | |
|--------------------------------|-----|---------|-------|
| silberfarbig silver | 1,0 | 65300-4 | 12,02 |
| | 2,7 | 65302-8 | 32,40 |
| goldfarbig gold | 1,0 | 65310-3 | 12,60 |
| | 2,7 | 65312-7 | 34,00 |
| bronzef. hell bronze light | 1,0 | 65320-2 | 14,02 |
| | 2,7 | 65322-6 | 37,88 |
| bronzef. dunkel bronze dark | 1,0 | 65330-1 | 14,02 |
| | 2,7 | 65332-5 | 37,88 |

| | |
|---------|-------|
| 65304-2 | 12,96 |
| 65306-6 | 35,24 |
| 65314-1 | 13,56 |
| 65316-5 | 36,88 |
| 65324-0 | 14,98 |
| 65326-4 | 40,76 |
| 65334-9 | 14,98 |
| 65336-3 | 40,76 |

496 wendbares Treppenseitenprofil 3 / 5 mm, Aluminium eloxiert, ungebohrt

turnable stair side profile
3 / 5 mm, aluminium
anodized, undrilled



| | | | |
|--------------------------------|-----|---------|-------|
| silberfarbig silver | 2,7 | 71330-2 | 15,36 |
| goldfarbig gold | | 71332-6 | 15,64 |
| bronzef. hell bronze light | | 71334-0 | 19,04 |
| bronzef. dunkel bronze dark | | 71336-4 | 19,04 |

| | |
|---------|-------|
| 71338-8 | 16,08 |
| 71340-1 | 16,34 |
| 71342-5 | 19,76 |
| 71344-9 | 19,76 |



| | |
|---|--|
| Befestigungsschenkel ausklinken attachment flanges notched | |
| Befestigungsschenkel ausklinken und biegen attachment flanges notched and bent | |

| Art./ref. | €/m |
|---------------------------|------|
| 22240-8 | 6,76 |
| auf Anfrage on request | |

1. WINKELPROFILE + TREPPENKANTEN AUS ALUMINIUM + MESSING / 1. ANGLE EDGES + STAIR NOSINGS ALU + BRASS

Andere Eloxalfarben siehe
 Abschnitt 6, Lieferzeit 14 Tag/
 other anodized colours see
 section 6, delivery time 14 days

| Treppeninnenecken aus Aluminium | | | |
|---|-------------|-----------|-------------|
| stair inside corners out of aluminium | | | |
| Profi-Pack à 10 Stück im Bund | | | |
| professional packing à 10 pcs. | | | |
| Farbe/colour | L / l (m) | Art./ref. | €/Stk./pcs. |
| SB-Pack incl. Schr./ Dübel; VE 20 Stk. | | | |
| self-service-pack with screws/ dowels; à 20 pcs. | | | |
| Art./ref. | €/Stk./pcs. | | |

369 Treppeninnenecke 3 mm, Aluminium eloxiert, gebohrt

stair inside corner 3 mm,
 aluminium anodized, drilled

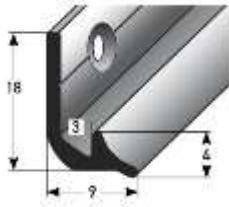

| | | | | | |
|--------------------------------|-----|---------|-------|---------|-------|
| silberfarbig silver | 1,0 | 66426-0 | 6,10 | 66427-7 | 7,04 |
| | 2,7 | 66428-4 | 16,50 | 66429-1 | 19,38 |
| goldfarbig gold | 1,0 | 66430-7 | 6,28 | 66431-4 | 7,24 |
| | 2,7 | 66432-1 | 16,98 | 66433-8 | 19,82 |
| bronzef. hell bronze light | 1,0 | 66434-5 | 6,90 | 66435-2 | 7,86 |
| | 2,7 | 66436-9 | 18,60 | 66437-6 | 21,50 |
| bronzef. dunkel bronze dark | 1,0 | 66438-3 | 6,90 | 66439-0 | 7,86 |
| | 2,7 | 66440-6 | 18,60 | 66441-3 | 21,50 |

370 Treppeninnenecke 5 mm, Aluminium eloxiert, gebohrt

stair inside corner 5 mm,
 aluminium anodized, drilled

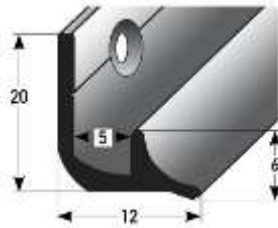

| | | | | | |
|--------------------------------|-----|---------|-------|---------|-------|
| silberfarbig silver | 1,0 | 66444-4 | 6,98 | 66445-1 | 7,96 |
| | 2,7 | 66446-8 | 18,86 | 66447-5 | 21,74 |
| goldfarbig gold | 1,0 | 66448-2 | 7,20 | 66449-9 | 8,14 |
| | 2,7 | 66450-5 | 19,42 | 66451-2 | 22,30 |
| bronzef. hell bronze light | 1,0 | 66452-9 | 7,76 | 66453-6 | 8,70 |
| | 2,7 | 66454-3 | 20,98 | 66455-0 | 23,84 |
| bronzef. dunkel bronze dark | 1,0 | 66456-7 | 7,76 | 66457-4 | 8,70 |
| | 2,7 | 66458-1 | 20,98 | 66459-8 | 23,84 |

Beispiel: Treppeninnenecke 5 mm,
 Aluminium eloxiert, gebohrt,
 siehe oben
 example: stair inside corner 5 mm,
 aluminium anodized, drilled,
 see above



1. WINKELPROFILE + TREPPENKANTEN AUS ALUMINIUM + MESSING / 1. ANGLE EDGES + STAIR NOSINGS ALU + BRASS

| Profi-Pack à 10 Stück im Bund | | | |
|--------------------------------|-----------|-----------|-------------|
| professional packing à 10 pcs. | | | |
| Farbe/colour | L / l (m) | Art./ref. | €/Stk./pcs. |

| SB-Pack incl. Schr./ Dübel; VE 20 Stk. | |
|---|-------------|
| self-service-pack with screws/ dowels; à 20 pcs. | |
| Art./ref. | €/Stk./pcs. |

205 Treppenkante 10 x 30 x 1,2 mm, Messing poliert, profilierte Riffelung, gebohrt

stair nosing 10 x 30 x 1,2 mm,
brass polished, fluted profile,
drilled

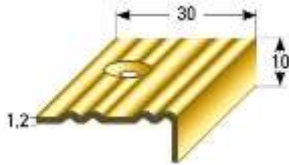

| | | | |
|--|-----|---------|-------|
| MESSING poliert brass polished | 1,0 | 61850-8 | 18,84 |
| | 2,7 | 61870-6 | 50,90 |

| | |
|---------|-------|
| 61860-7 | 20,64 |
| 61880-5 | 55,58 |

Bitte fordern Sie unsere Pflegehinweise für Messingprofile an!
 Please ask for our care tips for brass profiles!

270 Treppenkante 20 x 40 x 1,5 mm, Messing matt, profilierte Riffelung, gebohrt

stair nosing 20 x 40 x 1,5 mm,
brass matt, fluted profile, drilled

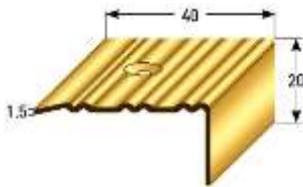

| | | | |
|-----------------------------------|-----|---------|-------|
| MESSING matt brass matt | 1,0 | 46600-0 | 39,62 |
| | 2,0 | 46602-4 | 79,18 |

| | |
|---------|-------|
| 46604-8 | 40,66 |
| 46606-2 | 81,34 |

Bitte fordern Sie unsere Pflegehinweise für Messingprofile an!
 Please ask for our care tips for brass profiles!

271 Treppenkante 40 x 40 x 1,5 mm, Messing matt, profilierte Riffelung, gebohrt

stair nosing 40 x 40 x 1,5 mm,
brass matt, fluted profile, drilled

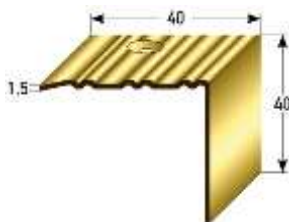

| | | | |
|-----------------------------------|-----|---------|--------|
| MESSING matt brass matt | 1,0 | 46610-9 | 51,66 |
| | 2,0 | 46612-3 | 103,34 |

| | |
|---------|--------|
| 46614-7 | 52,74 |
| 46616-1 | 105,52 |

Bitte fordern Sie unsere Pflegehinweise für Messingprofile an!
 Please ask for our care tips for brass profiles!

98 Treppenkante 15 x 35 mm, Messing poliert, gebohrt

stair nosing 15 x 35 mm,
brass polished, drilled

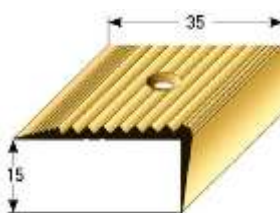

| | | | |
|--|-----|---------|--------|
| MESSING poliert brass polished | 1,0 | 28712-4 | 51,02 |
| | 2,5 | 28710-0 | 127,58 |

| | |
|---------|--------|
| 28713-1 | 52,18 |
| 28711-7 | 131,00 |

Bitte fordern Sie unsere Pflegehinweise für Messingprofile an!
 Please ask for our care tips for brass profiles!

1. WINKELPROFILE + TREPPENKANTEN AUS ALUMINIUM + MESSING / 1. ANGLE EDGES + STAIR NOSINGS ALU + BRASS

Andere Eloxalfarben siehe
 Abschnitt 6, Lieferzeit 14 Tage
 other anodized colours see
 section 6, delivery time 14 days

| Profi-Pack à 10 Stück im Bund | | | |
|--------------------------------|-----------|-----------|-------------|
| professional packing à 10 pcs. | | | |
| Farbe/colour | L / l (m) | Art./ref. | €/Stk./pcs. |

| SB-Pack incl. Schr./ Dübel; VE 20 Stk. | |
|---|-------------|
| self-service-pack with screws/ dowels; à 20 pcs. | |
| Art./ref. | €/Stk./pcs. |

82 Kombi-Treppenkante 23 x 40 mm, Aluminium eloxiert, gebohrt

combination stair nosing
 23 x 40 mm, aluminium
 anodized, drilled



| | | | | | |
|--------------------------------|-----|---------|-------|---------|-------|
| silberfarbig silver | 1,0 | 07501-1 | 14,14 | | |
| | 2,5 | 07500-4 | 35,34 | 07502-8 | 37,88 |
| goldfarbig gold | 1,0 | 07521-9 | 14,38 | | |
| | 2,5 | 07520-2 | 36,04 | 07522-6 | 38,58 |
| bronzef. hell bronze light | 1,0 | 07541-7 | 16,36 | | |
| | 2,5 | 07540-0 | 40,94 | 07542-4 | 43,58 |
| bronzef. dunkel bronze dark | 1,0 | 07561-5 | 16,36 | | |
| | 2,5 | 07560-8 | 40,94 | 07562-2 | 43,58 |

passend für Einlage 27 mm, siehe Nr. 121, Seite 22
 suitable for insert 27 mm, see no. 121, page 22

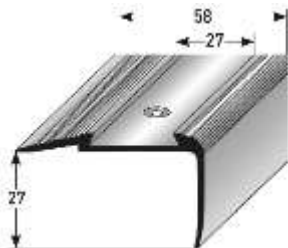

81 Kombi-Treppenkante 27 x 58 mm, Aluminium eloxiert, gebohrt

combination stair nosing
 27 x 58 mm, aluminium
 anodized, drilled



| | | | | | |
|--------------------------------|-----|---------|-------|---------|-------|
| silberfarbig silver | 1,0 | 07941-5 | 14,96 | | |
| | 2,5 | 07940-8 | 37,40 | 07942-2 | 39,82 |
| goldfarbig gold | 1,0 | 07951-4 | 18,72 | | |
| | 2,5 | 07950-7 | 46,82 | 07952-1 | 49,38 |
| bronzef. hell bronze light | 1,0 | 07961-3 | 20,72 | | |
| | 2,5 | 07960-6 | 51,76 | 07962-0 | 54,36 |
| bronzef. dunkel bronze dark | 1,0 | 07971-2 | 20,72 | | |
| | 2,5 | 07970-4 | 51,76 | 07972-9 | 54,36 |

Aluminium mit abriebfester Spezialmaillierung, gebohrt/ aluminium enameled, hard wearing, drilled

| | | | | | |
|--|-------|-----------|--------|-----------|--------|
|  Edelst.-Emaillbeschichtung Farbton - dunkelgrau stainless steel-enameled, colour - dark grey | 1,0 | 40100-1 | 37,68 | 40101-8 | 39,64 |
| | 2,0 | 72764-4 | 75,36 | 72766-8 | 79,26 |
| | 2,5 * | 40110-0 * | 94,20 | 40111-7 * | 100,06 |
|  Emaillbeschichtung Farbton - silber metallic stainless steel-enameled, colour - silver metallic | 1,0 | 40250-3 | 46,96 | 40252-7 | 48,90 |
| | 2,0 | 72768-2 | 93,90 | 72770-5 | 97,80 |
| | 2,5 * | 40251-0 * | 117,38 | 40253-4 * | 123,24 |

passend für Einlage 27 mm, siehe Nr. 121, Seite 22
 suitable for insert 27 mm, see no. 121, page 22

* Auslaufartikel / discontinued item

147 Kombi-Treppenkante 45 x 58 mm, Aluminium eloxiert, gebohrt

combination stair nosing
 45 x 58 mm, aluminium
 anodized, drilled

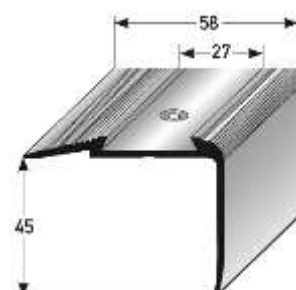

| | | | | | |
|--------------------------------|-----|---------|-------|---------|-------|
| silberfarbig silver | 1,0 | 42700-1 | 20,44 | | |
| | 2,7 | 42705-6 | 55,20 | 42710-0 | 57,82 |
| goldfarbig gold | 1,0 | 42715-5 | 21,64 | | |
| | 2,7 | 42720-9 | 58,26 | 42725-4 | 60,84 |
| bronzef. hell bronze light | 1,0 | 42730-8 | 23,84 | | |
| | 2,7 | 42735-3 | 64,46 | 42740-7 | 66,98 |
| bronzef. dunkel bronze dark | 1,0 | 42745-2 | 23,84 | | |
| | 2,7 | 42750-6 | 64,46 | 42755-1 | 66,98 |

passend für Einlage 27 mm, siehe Nr. 121, Seite 22
 suitable for insert 27 mm, see no. 121, page 22

1. WINKELPROFILE + TREPPENKANTEN AUS ALUMINIUM + MESSING / 1. ANGLE EDGES + STAIR NOSINGS ALU + BRASS

Andere Eloxalfarben siehe
Abschnitt 6, Lieferzeit 14 Tage
other anodized colours see
section 6, delivery time 14 days

| Profi-Pack à 10 Stück im Bund | | | |
|--------------------------------|-----------|-----------|-------------|
| professional packing à 10 pcs. | | | |
| Farbe/colour | L / l (m) | Art./ref. | €/Stk./pcs. |

| SB-Pack incl. Schr./ Dübel; VE 20 Stk. | |
|---|-------------|
| self-service-pack with screws/ dowels; à 20 pcs. | |
| Art./ref. | €/Stk./pcs. |

146 Kombi-Treppenkante 80 x 58 mm, Aluminium eloxiert, gebohrt

combination stair nosing
80 x 58 mm, aluminium
anodized, drilled

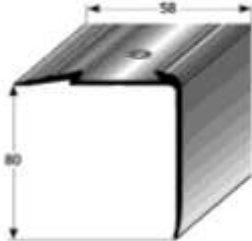

| | | | |
|--------------------------------|-----|---------|-------|
| silberfarbig silver | 1,0 | 42760-5 | 27,76 |
| | 2,7 | 42765-0 | 74,96 |
| goldfarbig gold | 1,0 | 42775-9 | 29,28 |
| | 2,7 | 42780-3 | 79,14 |
| bronzef. hell bronze light | 1,0 | 42790-2 | 32,40 |
| | 2,7 | 42795-7 | 87,44 |
| bronzef. dunkel bronze dark | 1,0 | 42805-3 | 32,40 |
| | 2,7 | 42810-7 | 87,44 |

| | |
|---------|-------|
| 42770-4 | 77,52 |
| 42785-8 | 81,72 |
| 42800-8 | 90,00 |
| 42815-2 | 90,00 |

passend für Einlage 27 mm, siehe Nr. 121, unten/ suitable for insert 27 mm, no. 121, see below

Der lange Schenkel kann gekürzt werden./ The long side can be shortened on request.

121 PVC-Einlage 27 mm, Weich-PVC

für Kombi-Treppenkanten
Nr. 81, 82, 146 und 147

PVC-insert 27 mm for
combination stair nosing
no. 81, 82, 146 +147
made of soft PVC



| | | eben/ smooth | | gerippt/ ribbed | |
|------|----------------|-----------------|---------------------|--------------------|---------------------|
| 25 m | grau/ grey | 55301-4 | 3,14/m 78,48/Ro. | 56301-3 | 3,14/m 78,48/Ro. |
| | schwarz/ black | 55302-1 | | | |
| | braun/ brown | 55303-8 | | | |
| | beige/ beige | 55304-5 | | | |
| | rot/ red | 55309-0 | | | |
| | blau/ blue | 55300-7 | | | |

| | | | | |
|--|------|---|---------|-----------------------|
| Extrem nachleuchtend extremely photoluminescent | 25 m | mit extremer Leuchtkraft with extreme luminosity | 40135-3 | 21,36/m 533,98/Ro. |
|--|------|---|---------|-----------------------|

Für Zuschnitte erheben wir einen Arbeitsaufschlag von 15 %./ For cuttings we charge a labor surcharge of 15%.

Montagehinweis: Bei der Montage sind die Enden der Einlagen mit Montagekleber an der Schiene zu befestigen.

Installation advice: Fix the ends of the inserts at the profile with installation glue.

| Profi-Pack à 10 Stück im Bund | | | |
|--------------------------------|-----------|-----------|-------------|
| professional packing à 10 pcs. | | | |
| Farbe/colour | L / l (m) | Art./ref. | €/Stk./pcs. |

| SB-Pack incl. Schr./ Dübel; VE 20 Stk. | |
|---|-------------|
| self-service-pack with screws/ dowels; à 20 pcs. | |
| Art./ref. | €/Stk./pcs. |

92 Treppenkante 15 x 36 mm, Aluminium eloxiert, gebohrt, passend für Einlage 12 mm, siehe unten

stair nosing 15 x 36 mm,
aluminium anodized, drilled,
suitable for insert 12 mm, see below

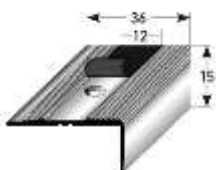

| | | | |
|--------------------------------|-----|---------|-------|
| silberfarbig silver | 1,0 | 07710-7 | 10,50 |
| | 2,7 | 07720-6 | 28,24 |
| goldfarbig gold | 1,0 | 07730-5 | 10,82 |
| | 2,7 | 07740-4 | 29,26 |
| bronzef. hell bronze light | 1,0 | 07750-3 | 12,42 |
| | 2,7 | 07760-2 | 33,52 |
| bronzef. dunkel bronze dark | 1,0 | 07770-1 | 12,42 |
| | 2,7 | 07780-0 | 33,52 |

| | |
|---------|-------|
| 07711-4 | 11,44 |
| 07721-3 | 30,78 |
| 07731-2 | 11,76 |
| 07741-1 | 31,84 |
| 07751-0 | 13,36 |
| 07761-9 | 36,16 |
| 07771-8 | 13,36 |
| 07781-7 | 36,16 |

486 Easy-Clean-Einlage 12 mm, rau,

selbstklebend, für Treppenkante Nr. 92

easy-clean insert 12 mm,
self-adhesive, rough,
for stair nosing no. 92



| Farbe/colour | L / l (m) | Art./ref. | € |
|------------------------------|-----------------------|-----------|---------------------|
| schwarz/ black | Rolle/ roll à 25 m | 71100-1 | 2,56/m |
| grau/ grey | | 71102-5 | 63,74/Ro. |
| gelb-schwarz yellow-black | | 71104-9 | 2,70/m 67,84/Ro. |

Für Zuschnitte erheben wir einen Arbeitsaufschlag von 15 %.
For cuttings we charge a labor surcharge of 15%.

Achtung! Verlegeanleitung für Einlagen beachten! Siehe Abschnitt 13.

Attention! Please follow the installation advice in section 13.

1. WINKELPROFILE + TREPPENKANTEN AUS ALUMINIUM + MESSING / 1. ANGLE EDGES + STAIR NOSINGS ALU + BRASS

Andere Eloxalfarben siehe
Abschnitt 6, Lieferzeit 14 Tage/
other anodized colours see
section 6, delivery time 14 days

| Profi-Pack à 10 Stück im Bund | | | |
|--------------------------------|-----------|-----------|-------------|
| professional packing à 10 pcs. | | | |
| Farbe/colour | L / l (m) | Art./ref. | €/Stk./pcs. |

| SB-Pack incl. Schr./ Dübel; VE 20 Stk. | |
|---|-------------|
| self-service-pack with screws/ dowels; à 20 pcs. | |
| Art./ref. | €/Stk./pcs. |

373 Treppenkante 39 x 48 mm, Aluminium eloxiert, gebohrt

stair nosing 39 x 48 mm,
aluminium anodized, drilled

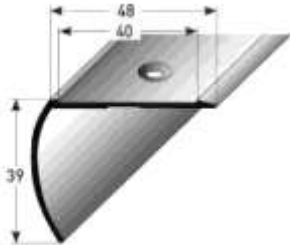

| | | | |
|--------------------------------|-----|---------|-------|
| silberfarbig silver | 1,0 | 66362-1 | 14,12 |
| | 2,7 | 66364-5 | 38,08 |
| goldfarbig gold | 1,0 | 66368-3 | 14,72 |
| | 2,7 | 66370-6 | 39,78 |
| bronzef. hell bronze light | 1,0 | 66374-4 | 16,76 |
| | 2,7 | 66376-8 | 45,26 |
| bronzef. dunkel bronze dark | 1,0 | 66380-5 | 16,76 |
| | 2,7 | 66382-9 | 45,26 |

| | |
|---------|-------|
| 66366-9 | 40,94 |
| 66372-0 | 42,62 |
| 66378-2 | 48,10 |
| 66384-3 | 48,10 |

passend für Einlage 39 mm, Nr. 375+487, siehe unten/ suitable for insert 39 mm, no. 375+487, see below .

374 Treppenkante 43 x 50 mm, Aluminium eloxiert, gebohrt

stair nosing 43 x 50 mm,
aluminium anodized, drilled

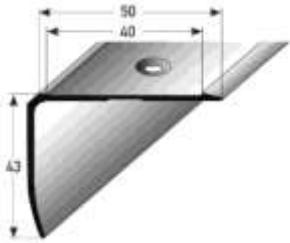

| | | | |
|--------------------------------|-----|---------|-------|
| silberfarbig silver | 1,0 | 66388-1 | 14,94 |
| | 2,7 | 66390-4 | 40,34 |
| goldfarbig gold | 1,0 | 66394-2 | 17,10 |
| | 2,7 | 66396-6 | 46,14 |
| bronzef. hell bronze light | 1,0 | 66400-0 | 17,68 |
| | 2,7 | 66402-4 | 47,78 |
| bronzef. dunkel bronze dark | 1,0 | 66406-2 | 17,68 |
| | 2,7 | 66408-6 | 47,78 |

| | |
|---------|-------|
| 66392-8 | 43,18 |
| 66398-0 | 49,00 |
| 66404-8 | 50,62 |
| 66410-9 | 50,62 |

passend für Einlage 39 mm, Nr. 375+487, siehe unten/ suitable for insert 39 mm, no. 375+487, see below .

375 Easy-Clean-Einlage 39 mm, rau, selbstklebend

easy-clean insert 39 mm,
rough, self-adhesive



| Farbe/colour | L / l (m) | Art./ref. | € |
|------------------------------|-----------|-----------|-----------|
| schwarz/ black | 25 m | 66416-1 | 3,04/m |
| | | 66414-7 | 76,12/Ro. |
| gelb-schwarz yellow-black | | 66418-5 | 3,60/m |
| | | 90,28/Ro. | |

487 Anti-Rutsch-Einlage 39 mm, grobe Körnung K60, selbstklebend

anti-slip insert 39 mm,
coarse grain K60,
self-adhesive

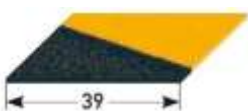

| | | | |
|----------------|------|---------|--------|
| schwarz/ black | 25 m | 71110-0 | 3,04/m |
| | | 71112-4 | |
| braun/ brown | | 71114-8 | 3,60/m |
| | | 71116-2 | |

Für Zuschnitte erheben wir einen Arbeitsaufschlag von 15 %.
For cuttings we charge a labor surcharge of 15%.

Achtung!! Bitte die Verlegeanleitung für Einlagen beachten! Siehe Abschnitt 13.
Attention!! Please follow the installation advice in section 13.

passend für Übergangsprofil Nr. 412 & Treppenkanten Nr. 373/ 374/ 394-396
suitable for connecting profile no. 412 and stair nosing no. 373/ 374/ 394-396

1. WINKELPROFILE + TREPPENKANTEN AUS ALUMINIUM + MESSING / 1. ANGLE EDGES + STAIR NOSINGS ALU + BRASS

Andere Eloxalfarben siehe
Abschnitt 6, Lieferzeit 14 Tage/
other anodized colours see
section 6, delivery time 14 days

| Profi-Pack à 10 Stück im Bund | | | |
|--------------------------------|-----------|-----------|-------------|
| professional packing à 10 pcs. | | | |
| Farbe/colour | L / l (m) | Art./ref. | €/Stk./pcs. |

| SB-Pack incl. Schr./ Dübel; VE 20 Stk. | |
|---|-------------|
| self-service-pack with screws/ dowels; à 20 pcs. | |
| Art./ref. | €/Stk./pcs. |

500 Treppenkante 30 x 60 mm, Aluminium eloxiert, gebohrt

stair nosing 30 x 60 mm,
aluminium anodized, drilled



| | | | |
|--------------------------------|-----|---------|-------|
| silberfarbig silver | 1,0 | 71534-4 | 16,00 |
| | 2,7 | 71536-8 | 43,22 |
| goldfarbig gold | 1,0 | 71538-2 | 16,62 |
| | 2,7 | 71540-5 | 44,88 |
| bronzef. hell bronze light | 1,0 | 71542-9 | 18,08 |
| | 2,7 | 71544-3 | 48,82 |
| bronzef. dunkel bronze dark | 1,0 | 71546-7 | 18,72 |
| | 2,7 | 71548-1 | 50,54 |

| | |
|---------|-------|
| 71550-4 | 16,94 |
| 71552-8 | 45,98 |
| 71554-2 | 17,54 |
| 71556-6 | 47,62 |
| 71558-0 | 19,00 |
| 71560-3 | 51,56 |
| 71562-7 | 19,64 |
| 71564-1 | 53,28 |

Gemäß DIN 18040-2 "Barrierefreies Bauen" kann auf der Setzstufe eine 23 mm-Einlage verklebt werden.
According to DIN 18040-2 "barrier-free construction" a 23 mm insert can be glued on the riser.

passend für 50 mm-Einlage, Nr. 504+505, auf Trittstufe und 23 mm-Einlage, Nr. 489+490, an Setzstufe, siehe unten & nächste Seite/ suitable for tread insert 50 mm, no.504+505, and for riser 23 mm insert,no. 489+490, see below and next page

504 Easy-Clean-Einlage 50 mm, rau, selbstklebend

easy-clean insert 50 mm,
rough, self-adhesive



| Farbe/colour | L / l (m) | Art./ref. | € |
|------------------------------|-----------|-----------|----------------------|
| schwarz/ black | 25 m | 71570-2 | 3,90/m |
| grau/ grey | | 71572-6 | 97,36/Ro. |
| gelb-schwarz yellow-black | | 71574-0 | 4,64/m 115,66/Ro. |

505 Anti-Rutsch-Einlage 50 mm, grobe Körnung K60, selbstklebend

anti-slip insert 50 mm,
coarse grain K60,
self-adhesive

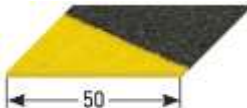

| | | | |
|------------------------------|------|---------|--------------------|
| schwarz/ black | 25 m | 71580-1 | 3,90/m |
| grau/ grey | | 71582-5 | 97,36/Ro. |
| gelb-schwarz yellow-black | | 71584-9 | 4,64/m 115,66/m |

Für Zuschnitte erheben wir einen Arbeitsaufschlag von 15 %. / For cuttings we charge a labor surcharge of 15%.

passend für Treppenkante Nr. 500
suitable for stair nosing nr. 500

Achtung!! Bitte die Verlegeanleitung für Einlagen beachten!
Siehe Abschnitt 13. / Attention!! Please follow the installation advice in section 13.

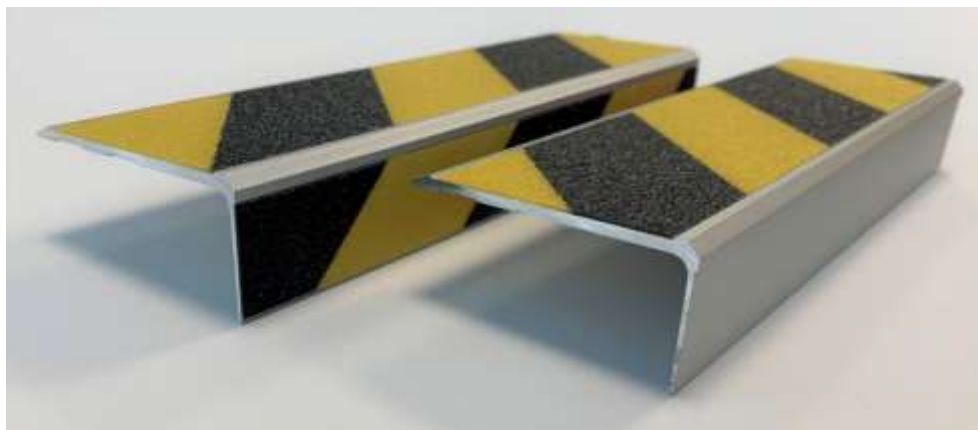

Beispiel: Treppenkanten 30 x 60 mm mit Einlage 50 mm gelb-schwarz beklebt, ohne und mit Setzstufenbeklebung mit 23 mm Einlage

example: stair nosings 30 x 60 mm with 50 mm yellow-black insert, without and with 23 mm insert on the riser

1. WINKELPROFILE + TREPPENKANTEN AUS ALUMINIUM + MESSING / 1. ANGLE EDGES + STAIR NOSINGS ALU + BRASS

Andere Eloxalfarben siehe
Abschnitt 6, Lieferzeit 14 Tage/
other anodized colours see
section 6, delivery time 14 days

| Profi-Pack à 10 Stück im Bund | | | |
|--------------------------------|-----------|-----------|-------------|
| professional packing à 10 pcs. | | | |
| Farbe/colour | L / l (m) | Art./ref. | €/Stk./pcs. |

| SB-Pack incl. Schr./ Dübel; VE 20 Stk. | |
|---|-------------|
| self-service-pack with screws/ dowels; à 20 pcs. | |
| Art./ref. | €/Stk./pcs. |

86 Treppenkante 28,5 x 53 mm, Aluminium eloxiert, gebohrt

stair nosing 28,5 x 53 mm,
aluminium anodized, drilled

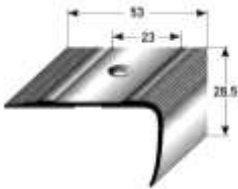

| | | | | | |
|--------------------------------|-----|---------|-------|---------|-------|
| silberfarbig silver | 1,0 | 35440-6 | 17,28 | | |
| | 2,7 | 35400-0 | 46,64 | 35401-7 | 49,24 |
| goldfarbig gold | 1,0 | 35450-5 | 17,86 | | |
| | 2,7 | 35410-9 | 48,12 | 35411-6 | 50,70 |
| bronzef. hell bronze light | 1,0 | 35460-4 | 20,26 | | |
| | 2,7 | 35420-8 | 54,78 | 35421-5 | 57,38 |
| bronzef. dunkel bronze dark | 1,0 | 35470-3 | 20,26 | | |
| | 2,7 | 35430-7 | 54,78 | 35431-4 | 57,38 |

passend für Einlage 23 mm, Nr. 489+490, siehe unten/ suitable for insert 23 mm, no. 489+490, see below

80 Treppenkante 28,5 x 75 mm, Aluminium eloxiert, gebohrt

stair nosing 28,5 x 75 mm,
aluminium anodized, drilled

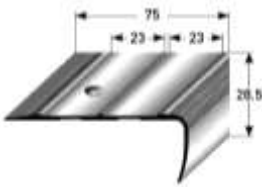

| | | | | | |
|--------------------------------|-----|---------|-------|---------|-------|
| silberfarbig silver | 1,0 | 39660-4 | 20,72 | | |
| | 2,7 | 39670-3 | 55,90 | 39671-0 | 58,48 |
| goldfarbig gold | 1,0 | 39680-2 | 21,50 | | |
| | 2,7 | 39690-1 | 57,96 | 39691-8 | 60,56 |
| bronzef. hell bronze light | 1,0 | 39700-7 | 24,02 | | |
| | 2,7 | 39710-6 | 64,96 | 39711-3 | 67,54 |
| bronzef. dunkel bronze dark | 1,0 | 39720-5 | 24,02 | | |
| | 2,7 | 39730-4 | 64,96 | 39731-1 | 67,54 |

passend für Einlage 23 mm, Nr. 489+490, siehe unten/ suitable for insert 23 mm, no. 489+490, see below

Achtung: doppelte Menge der Einlage berücksichtigen/ Attention: Consider double amount of insert!

489 Easy-Clean-Einlage 23 mm, rau, selbstklebend

easy-clean insert 23 mm,
self-adhesive, rough



| Farbe/colour | L / l (m) | Art./ref. | € |
|------------------------------|-----------------------|-----------|---------------------|
| schwarz/ black | Rolle/ roll à 25 m | 71122-3 | 2,80/m |
| grau/ grey | | 71124-7 | 69,64/Ro. |
| gelb-schwarz yellow-black | | 71126-1 | 3,06/m 76,70/Ro. |

für Treppenkanten Nr. 80 / 86 / 500
for stair nosings no. 80 / 86 / 500

490 Anti-Rutsch-Einlage 23 mm, grobe Körnung K60, selbstklebend,

anti-slip insert 23 mm,
coarse grain K60,
self-adhesive

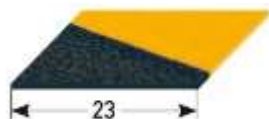

| | | | |
|------------------------------|-----------------------|---------|---------------------|
| schwarz/ black | Rolle/ roll à 25 m | 71132-2 | 2,80/m |
| grau/ grey | | 71134-6 | 69,64/Ro. |
| braun/ brown | | 71136-0 | |
| gelb-schwarz yellow-black | | 71138-4 | 3,06/m 76,70/Ro. |

für Treppenkanten Nr. 80 / 86 / 500
for stair nosings no. 80 / 86 / 500

Für Zuschnitte erheben wir einen Arbeitsaufschlag von 15 %. / For cuttings we charge a labor surcharge of 15%.

Achtung! Verlegeanleitung für Einlagen beachten!
Siehe Abschnitt 13.
Attention! Please follow the installation advice in section 13.

1. WINKELPROFILE + TREPPENKANTEN AUS ALUMINIUM + MESSING / 1. ANGLE EDGES + STAIR NOSINGS ALU + BRASS

Andere Eloxalfarben siehe
Abschnitt 6, Lieferzeit 14 Tage/
other anodized colours see section 6,
delivery time 14 days

| Profi-Pack à 10 Stück im Bund | | | |
|--------------------------------|-----------|-----------|-------------|
| professional packing à 10 pcs. | | | |
| Farbe/colour | L / l (m) | Art./ref. | €/Stk./pcs. |

| SB-Pack incl. Schr./ Dübel; VE 20 Stk. | |
|---|-------------|
| self-service-pack with screws/ dowels; à 20 pcs. | |
| Art./ref. | €/Stk./pcs. |

264 Treppenkante 30 x 40 x 2 mm, Aluminium eloxiert, gebohrt

stair nosing 30 x 40 x 2 mm,
aluminium anodized, drilled

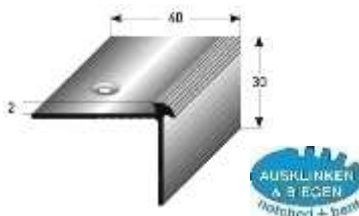

| | | | | | |
|--------------------------------|-----|---------|-------|---------|-------|
| silberfarbig silver | 1,0 | 46560-7 | 11,12 | 46564-5 | 12,08 |
| | 2,7 | 46562-1 | 30,00 | | |
| goldfarbig gold | 1,0 | 46570-6 | 11,54 | 46574-4 | 12,50 |
| | 2,7 | 46572-0 | 31,18 | | |
| bronzef. hell bronze light | 1,0 | 46580-5 | 13,42 | 46584-3 | 14,36 |
| | 2,7 | 46582-9 | 36,26 | | |
| bronzef. dunkel bronze dark | 1,0 | 46590-4 | 13,42 | 46594-2 | 14,36 |
| | 2,7 | 46592-8 | 36,26 | | |

| | |
|---------|-------|
| 46566-9 | 32,86 |
| 46576-8 | 34,00 |
| 46586-7 | 39,10 |
| 46596-6 | 39,10 |

386 Treppenkante 30 x 40 x 2,5 mm, Aluminium eloxiert, gebohrt

stair nosing 30 x 40 x 2,5 mm,
aluminium anodized, drilled



| | | | | | |
|--------------------------------|-----|---------|-------|---------|-------|
| silberfarbig silver | 1,0 | 66700-1 | 11,46 | 66724-7 | 12,34 |
| | 2,7 | 66702-5 | 30,84 | | |
| goldfarbig gold | 1,0 | 66704-9 | 12,94 | 66728-5 | 13,84 |
| | 2,7 | 66706-3 | 31,96 | | |
| bronzef. hell bronze light | 1,0 | 66708-7 | 13,76 | 66732-2 | 14,70 |
| | 2,7 | 66710-0 | 37,18 | | |
| bronzef. dunkel bronze dark | 1,0 | 66712-4 | 13,76 | 66736-0 | 14,70 |
| | 2,7 | 66714-8 | 37,18 | | |

| | |
|---------|-------|
| 66734-6 | 39,96 |
| 66738-4 | 39,96 |

134 Treppenkante 30 x 40 x 3 mm, Aluminium eloxiert, gebohrt

stair nosing 30 x 40 x 3 mm,
aluminium anodized, drilled

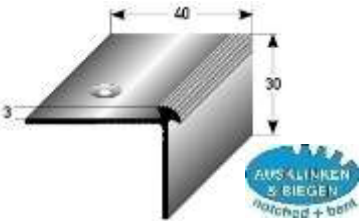

| | | | | | |
|--------------------------------|-----|---------|-------|---------|-------|
| silberfarbig silver | 1,0 | 41340-0 | 13,08 | 41341-7 | 14,00 |
| | 2,7 | 41350-9 | 35,16 | | |
| goldfarbig gold | 1,0 | 41360-8 | 13,56 | 41361-5 | 14,56 |
| | 2,7 | 41370-7 | 36,62 | | |
| bronzef. hell bronze light | 1,0 | 41380-6 | 14,80 | 41381-3 | 15,80 |
| | 2,7 | 41390-5 | 39,90 | | |
| bronzef. dunkel bronze dark | 1,0 | 41400-1 | 14,80 | 41401-8 | 15,80 |
| | 2,7 | 41410-0 | 39,90 | | |

| | |
|---------|-------|
| 41371-4 | 39,28 |
| 41391-2 | 42,54 |
| 41411-7 | 42,54 |

135 Treppenkante 30 x 40 x 5 mm, Aluminium eloxiert, gebohrt

stair nosing 30 x 40 x 5 mm,
aluminium anodized, drilled

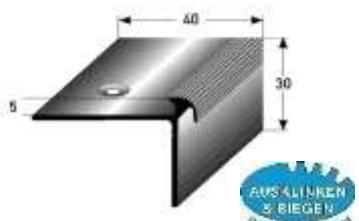

| | | | | | |
|--------------------------------|-----|---------|-------|---------|-------|
| silberfarbig silver | 1,0 | 41260-1 | 14,32 | 41261-8 | 15,28 |
| | 2,7 | 41270-0 | 38,72 | | |
| goldfarbig gold | 1,0 | 41280-9 | 14,96 | 41281-6 | 15,88 |
| | 2,7 | 41290-8 | 40,34 | | |
| bronzef. hell bronze light | 1,0 | 41300-4 | 16,30 | 41301-1 | 17,24 |
| | 2,7 | 41310-3 | 44,04 | | |
| bronzef. dunkel bronze dark | 1,0 | 41320-2 | 16,30 | 41321-9 | 17,24 |
| | 2,7 | 41330-1 | 44,04 | | |

| | |
|---------|-------|
| 41291-5 | 43,18 |
| 41311-0 | 46,90 |
| 41331-8 | 46,90 |



| | |
|---|--|
| Befestigungsschenkel ausklinken attachment flanges notched | |
| Befestigungsschenkel ausklinken und biegen attachment flanges notched and bent | |

| Art./ref. | €/m |
|---------------------------|------|
| 22240-8 | 6,76 |
| auf Anfrage on request | |

1. WINKELPROFILE + TREPPENKANTEN AUS ALUMINIUM + MESSING / 1. ANGLE EDGES + STAIR NOSINGS ALU + BRASS

Andere Eloxalfarben siehe
 Abschnitt 6, Lieferzeit 14 Tage/
 other anodized colours see
 section 6, delivery time 14 days

| Profi-Pack à 10 Stück im Bund | | | |
|--------------------------------|-----------|-----------|-------------|
| professional packing à 10 pcs. | | | |
| Farbe/colour | L / l (m) | Art./ref. | €/Stk./pcs. |

| SB-Pack incl. Schr./ Dübel; VE 20 Stk. | |
|---|-------------|
| self-service-pack with screws/ dowels; à 20 pcs. | |
| Art./ref. | €/Stk./pcs. |

519 Eckprofil 30 x 40 x 2 mm glatt, Aluminium eloxiert, gebohrt

corner profile 30 x 40 x 2 mm
 smooth, aluminium anodized,
 drilled



| | | | | | |
|--|-----|---------|-------|---------|-------|
| silberfarbig silver | 1,0 | 71880-2 | 11,12 | 71884-0 | 12,08 |
| | 2,7 | 71882-6 | 30,00 | | |
| edelstahlfarbig stainless steel coloured | 1,0 | 72696-8 | 13,30 | 72706-4 | 14,24 |
| | 2,7 | 72698-2 | 35,92 | | |
| schwarz black | 1,0 | 72700-2 | 13,30 | 72710-1 | 14,24 |
| | 2,7 | 72702-6 | 35,92 | | |

| | |
|---------|-------|
| 71884-0 | 12,08 |
| | |
| 72706-4 | 14,24 |
| | |
| 72710-1 | 14,24 |
| | |

520 Eckprofil 30 x 40 x 2,5 mm glatt, Aluminium eloxiert, gebohrt

corner profile 30 x 40 x 2,5 mm
 smooth, aluminium anodized,
 drilled



| | | | | | |
|--|-----|---------|-------|---------|-------|
| silberfarbig silver | 1,0 | 71890-1 | 11,46 | 71894-9 | 12,34 |
| | 2,7 | 71892-5 | 30,84 | | |
| edelstahlfarbig stainless steel coloured | 1,0 | 72714-9 | 13,66 | 72722-4 | 14,60 |
| | 2,7 | 72716-3 | 36,88 | | |
| schwarz black | 1,0 | 72718-7 | 13,66 | 72726-2 | 14,60 |
| | 2,7 | 72720-0 | 36,88 | | |

| | |
|---------|-------|
| 71894-9 | 12,34 |
| | |
| 72722-4 | 14,60 |
| | |
| 72726-2 | 14,60 |
| | |

521 Eckprofil 30 x 40 x 3 mm glatt, Aluminium eloxiert, gebohrt

corner profile 30 x 40 x 3 mm
 smooth, aluminium anodized,
 drilled



| | | | | | |
|--|-----|---------|-------|---------|-------|
| silberfarbig silver | 1,0 | 71900-7 | 13,08 | 71904-5 | 14,00 |
| | 2,7 | 71902-1 | 35,16 | | |
| edelstahlfarbig stainless steel coloured | 1,0 | 72730-9 | 15,34 | 72738-5 | 16,28 |
| | 2,7 | 72732-3 | 41,42 | | |
| schwarz black | 1,0 | 72734-7 | 15,34 | 72742-2 | 16,28 |
| | 2,7 | 72736-1 | 41,42 | | |

| | |
|---------|-------|
| 71904-5 | 14,00 |
| | |
| 72738-5 | 16,28 |
| | |
| 72742-2 | 16,28 |
| | |

522 Eckprofil 30 x 40 x 5 mm glatt, Aluminium eloxiert, gebohrt

corner profile 30 x 40 x 5 mm
 smooth, aluminium anodized,
 drilled



| | | | | | |
|--|-----|---------|-------|---------|-------|
| silberfarbig silver | 1,0 | 71910-6 | 14,32 | 71914-4 | 15,28 |
| | 2,7 | 71912-0 | 38,72 | | |
| edelstahlfarbig stainless steel coloured | 1,0 | 72746-0 | 16,84 | 72754-5 | 17,80 |
| | 2,7 | 72748-4 | 45,48 | | |
| schwarz black | 1,0 | 72750-7 | 16,84 | 72758-3 | 17,80 |
| | 2,7 | 72752-1 | 45,48 | | |

| | |
|---------|-------|
| 71914-4 | 15,28 |
| | |
| 72754-5 | 17,80 |
| | |
| 72758-3 | 17,80 |
| | |



| | | |
|---|---------------------------|------|
| Befestigungsschenkel ausklinken attachment flanges notched | Art./ref. | €/m |
| Befestigungsschenkel ausklinken und biegen attachment flanges notched and bent | 22240-8 | 6,76 |
| | auf Anfrage on request | |

5. EINSCHUB- & ANSTOßPROFILE/ 5. INSERT PROFILES

Andere Eloxalfarben siehe
 Abschnitt 6, Lieferzeit 14 Tage/
 other anodized colours see
 section 6, delivery time 14 days

| Profi-Pack à 10 Stück im Bund | | | |
|--------------------------------|-----------|-----------|-------------|
| professional packing à 10 pcs. | | | |
| Farbe/colour | L / l (m) | Art./ref. | €/Stk./pcs. |

| SB-Pack incl. Schr./ Dübel; VE 20 Stk. | |
|---|-------------|
| self-service-pack with screws/ dowels; à 20 pcs. | |
| Art./ref. | €/Stk./pcs. |

491 Treppenkante Doppelseinschub 3 mm, Aluminium eloxiert, 2 x gebohrt

double insert stair nosing
 3 mm, aluminium anodized,
 2 x drilled

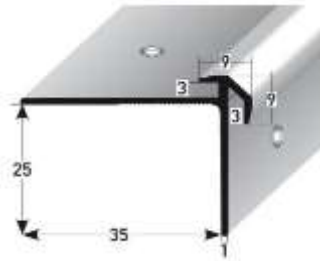

| | | | | | |
|---|-----|---------|-------|---------|-------|
| silberfarbig silver | 1,0 | 71144-5 | 12,34 | 71168-1 | 13,22 |
| | 2,7 | 71146-9 | 33,34 | | |
| goldfarbig gold | 1,0 | 71148-3 | 12,86 | 71170-4 | 35,94 |
| | 2,7 | 71150-6 | 34,74 | | |
| bronzef. hell bronze light | 1,0 | 71152-0 | 15,12 | 71172-8 | 13,74 |
| | 2,7 | 71154-4 | 40,84 | | |
| bronzef. dunkel bronze dark | 1,0 | 71156-8 | 15,12 | 71174-2 | 38,56 |
| | 2,7 | 71158-2 | 40,84 | | |
| gold hell gold light | 1,0 | 71160-5 | 12,86 | 71176-6 | 16,00 |
| | 2,7 | 71162-9 | 34,74 | | |
| edelstahlfarbig stainless steel coloured | 1,0 | 71164-3 | 15,12 | 71178-0 | 43,48 |
| | 2,7 | 71166-7 | 40,84 | | |
| | | | | 71180-3 | 16,00 |
| | | | | 71182-7 | 43,48 |
| | | | | 71184-1 | 13,74 |
| | | | | 71186-5 | 37,36 |
| | | | | 71188-9 | 16,00 |
| | | | | 71190-2 | 43,48 |

492 Treppenkante Doppelseinschub 5 mm, Aluminium eloxiert, 2 x gebohrt

double insert stair nosing
 5 mm, aluminium anodized,
 2 x drilled

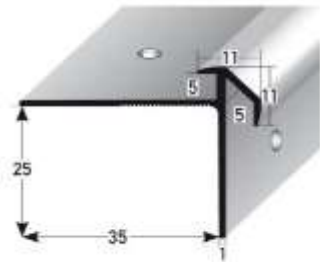

| | | | | | |
|---|-----|---------|-------|---------|-------|
| silberfarbig silver | 1,0 | 71196-4 | 12,82 | 71220-6 | 13,70 |
| | 2,7 | 71198-8 | 34,60 | | |
| goldfarbig gold | 1,0 | 71200-8 | 13,44 | 71222-0 | 37,22 |
| | 2,7 | 71202-2 | 36,32 | | |
| bronzef. hell bronze light | 1,0 | 71204-6 | 15,66 | 71224-4 | 14,32 |
| | 2,7 | 71206-0 | 42,26 | | |
| bronzef. dunkel bronze dark | 1,0 | 71208-4 | 15,66 | 71226-8 | 38,94 |
| | 2,7 | 71210-7 | 42,26 | | |
| gold hell gold light | 1,0 | 71212-1 | 13,44 | 71228-2 | 16,54 |
| | 2,7 | 71214-5 | 36,32 | | |
| edelstahlfarbig stainless steel coloured | 1,0 | 71216-9 | 15,66 | 71230-5 | 44,88 |
| | 2,7 | 71218-3 | 42,26 | | |
| | | | | 71232-9 | 16,54 |
| | | | | 71234-3 | 44,88 |
| | | | | 71236-7 | 14,32 |
| | | | | 71238-1 | 38,94 |
| | | | | 71240-4 | 16,54 |
| | | | | 71242-8 | 44,88 |

**Technische Datenblätter, Verlegehinweise, Materialbeschreibungen & Pflegehinweise
 erhalten Sie auf Anfrage oder unter www.Auer-Metallprofile.de**

Technical details, installation tips, material descriptions and care instructions are available
 on request or under www.Auer-Metallprofile.de

2. TREPPENKANTEN EDELSTAHL

2. STAIR NOSINGS STAINLESS STEEL

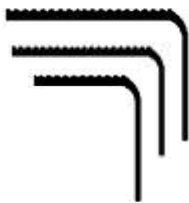
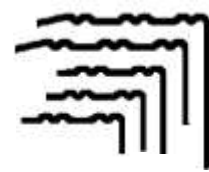
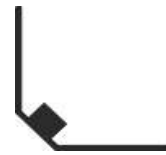

2. TREPPENKANTEN EDELSTAHL/ 2. STAIR NOSINGS STAINLESS STEEL

Edelstahlschrauben siehe
Abschnitt 12/ stainless steel
screws see section 12

394 Treppenkanten 25 x 63 x 1,5 mm INOX PROTECT, Edelstahl matt, gebohrt

stair nosing 25 x 63 x 1,5 mm
INOX PROTECT, stainless steel
matt, drilled

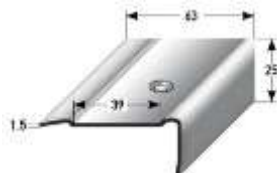

| Edelstahl-Treppenkanten INOX PROTECT zur Verlegung mit Einlage 39 mm | | | |
|---|---------|-----------|-------------|
| stainless steel stair nosings for installation with insert 39 mm | | | |
| L / l (m) | VE/unit | Art./ref. | €/Stk./pcs. |

| | | | |
|-------|--------------|---------|--------|
| 1,0 m | 5 Stück/pcs. | 67000-1 | 48,68 |
| 2,5 m | | 67002-5 | 121,70 |
| 3,0 m | | 67004-9 | 146,00 |

für Verlegung mit Einlage 39 mm, siehe Seite 23
for installation with insert 39 mm, see page 23

395 Treppenkanten 35 x 63 x 1,5 mm INOX PROTECT, Edelstahl matt, gebohrt

stair nosing 35 x 63 x 1,5 mm
INOX PROTECT, stainless steel
matt, drilled



| | | | |
|-------|--------------|---------|--------|
| 1,0 m | 5 Stück/pcs. | 67008-7 | 54,06 |
| 2,5 m | | 67010-0 | 135,20 |
| 3,0 m | | 67012-4 | 162,24 |

für Verlegung mit Einlage 39 mm, siehe Seite 23
for installation with insert 39 mm, see page 23

396 Treppenkanten 45 x 63 x 1,5 mm INOX PROTECT, Edelstahl matt, gebohrt

stair nosing 45 x 63 x 1,5 mm
INOX PROTECT, stainless steel
matt, drilled

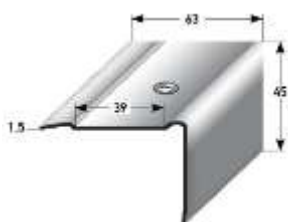

| | | | |
|-------|--------------|---------|--------|
| 1,0 m | 5 Stück/pcs. | 67016-2 | 59,48 |
| 2,5 m | | 67018-6 | 148,72 |
| 3,0 m | | 67020-9 | 178,46 |

für Verlegung mit Einlage 39 mm, siehe Seite 23
for installation with insert 39 mm, see page 23

Treppenkante INOX PROTECT
mit Einlage 39 mm, gelb-schwarz
(siehe oben bzw. Seite 23)
stair nosing INOX PROTECT
with insert 39 mm, yellow-black
(see above and at page 23)



3,0 m-Ware ist nur per Spedition lieferbar (gesonderte Transportkosten)
3,0 m profiles are only available per forwarding agency (separate transport costs)

Trennscheibe 115 x 1 mm Inox special, zum Trennen von Edelstahlprofilen

cutting disc 115 x 1 mm Inox special,
suitable for cutting stainless steel
profiles



| VE/unit | Art./ref. | €/Stk./pcs. |
|--------------|-----------|-------------|
| 1 Stück/pcs. | 22246-0 | 5,32 |

kaum Gratbildung bzw. thermische Blaufärbung
hardly any flashing and no discolouring

Fächerscheibe 115 x 22,2 mm, Körnung 60, zum Entgraten von Edelstahl

flap disc 115 x 22,2 mm, grain
size 60, suitable for deburring
stainless steel



| | | |
|--------------|---------|------|
| 1 Stück/pcs. | 22250-7 | 8,68 |
|--------------|---------|------|

2. TREPPENKANTEN EDELSTAHL/ 2. STAIR NOSINGS STAINLESS STEEL

Andere Abmaße auf Anfrage/

other dimensions
on demand

Edelstahl-Einschubprofile matt gebürstet für Höhen von 2 mm bis 22 mm

insert profiles out of stainless steel for highs from 2 mm till 22 mm

| Koffernr./ case no. | AxBxCxD (mm) | L / l (m) | VE/unit | Art./ref. | €/Stk./pcs. |
|------------------------|--------------|-----------|---------|-----------|-------------|
|------------------------|--------------|-----------|---------|-----------|-------------|

Einschubprofil mit Nase, Edelstahl matt, gebohrt

nosed insert profile, stainless steel matt, drilled

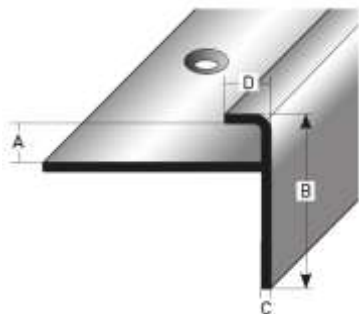

| | | | | | |
|-----|--------------------|-------|-----------------|---------|--------|
| 352 | 2 x 23 x 1,5 x 6 | 2,7 m | 10 Stk./pcs. | 60385-6 | 125,02 |
| 353 | 2,5 x 23 x 1,5 x 6 | | | 60395-5 | |
| 354 | 3 x 23 x 1,5 x 6 | | | 60405-1 | |
| 355 | 5 x 23 x 1,5 x 6 | | | 60416-7 | |
| 399 | 8 x 23 x 1,5 x 6 | | | 67662-1 | |
| 400 | 10 x 23 x 1,5 x 6 | | | 67668-3 | |
| 401 | 11 x 23 x 1,5 x 6 | | | 67674-4 | |
| 402 | 12 x 23 x 1,5 x 6 | | | 67680-5 | |
| 403 | 15 x 23 x 1,5 x 6 | | | 67686-7 | |

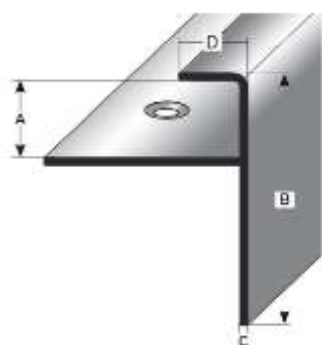

| | | | | | |
|-----|---------------------|-------|-----------------|---------|--------|
| 252 | 2,5 x 40 x 1,5 x 10 | 2,5 m | 10 Stk./pcs. | 60380-1 | 162,20 |
| 229 | 4,5 x 40 x 1,5 x 10 | | | 60390-0 | |
| 228 | 8 x 40 x 1,5 x 10 | | | 60400-6 | |
| 404 | 11 x 40 x 1,5 x 10 | | | 60402-0 | |
| 405 | 12 x 40 x 1,5 x 10 | | | 60408-2 | |
| 253 | 15 x 40 x 1,5 x 10 | | | 60410-5 | |
| 254 | 22 x 40 x 1,5 x 10 | | | 60420-4 | |

passende Edelstahlschrauben siehe Abschnitt 12/ suitable stainless steel screws see section 12

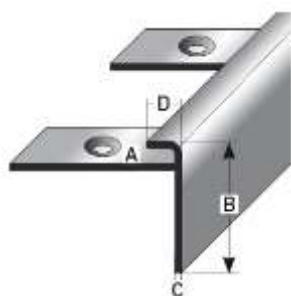

Profil biegen
profile bent

auf Anfrage
on request

Die Fertigung erfolgt auf Fixlängen, Verschnitt wird mit berechnet, ohne Zuschnittkosten.
Production takes place on fixed lengths, blended is charged with, without calculation of the cost of cutting.

2. TREPPENKANTEN EDELSTAHL/ 2. STAIR NOSINGS STAINLESS STEEL

Andere Abmaße auf Anfrage/ other dimensions on demand

Edelstahl-Treppeninnenecken matt gebürstet für Höhen von 2 mm bis 22 mm

stair inside corner out of stainless steel matt for heights from 2 mm till 22 mm

| Koffernr./ case no. | Für Belaghöhe = h in mm/ for flooring height = h in mm | L / l (m) | VE/unit | Art./ref. | €/Stk./pcs. |
|---------------------|--|-----------|---------|-----------|-------------|
|---------------------|--|-----------|---------|-----------|-------------|

Treppeninnenecke Edelstahl matt, gebohrt

stair inside corner, stainless steel matt, drilled

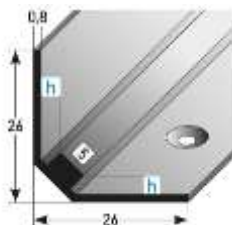

| | | | | | |
|-----|----------|-------|--------------|---------|--------|
| 367 | 2 - 3 mm | 1,0 m | 10 Stk./pcs. | 45621-6 | 41,12 |
| | | 2,7 m | | 45620-9 | 111,02 |

| | | | | | |
|-----|----------|-------|--------------|---------|--------|
| 368 | 3 - 5 mm | 1,0 m | 10 Stk./pcs. | 45616-2 | 43,56 |
| | | 2,7 m | | 45615-5 | 117,60 |

| | | | | | |
|-----|------|-------|--------------|---------|--------|
| 406 | 8 mm | 1,0 m | 10 Stk./pcs. | 67612-6 | 56,10 |
| | | 2,7 m | | 67614-0 | 151,48 |

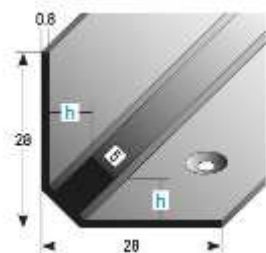

| | | | | | |
|-----|-------|-------|--------------|---------|--------|
| 407 | 10 mm | 1,0 m | 10 Stk./pcs. | 67620-1 | 56,10 |
| | | 2,7 m | | 67622-5 | 151,48 |

| | | | | | |
|-----|-------|-------|--------------|---------|--------|
| 408 | 11 mm | 1,0 m | 10 Stk./pcs. | 67628-7 | 59,16 |
| | | 2,7 m | | 67630-0 | 159,72 |

| | | | | | |
|-----|-------|-------|--------------|---------|--------|
| 409 | 12 mm | 1,0 m | 10 Stk./pcs. | 67636-2 | 59,16 |
| | | 2,7 m | | 67638-6 | 159,72 |

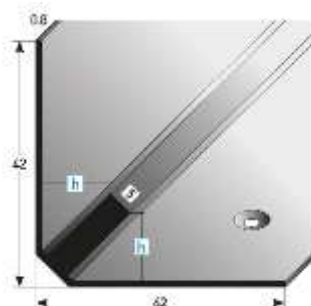

| | | | | | |
|-----|-------|-------|--------------|---------|--------|
| 410 | 15 mm | 1,0 m | 10 Stk./pcs. | 67644-7 | 65,74 |
| | | 2,7 m | | 67646-1 | 177,50 |

| | | | | | |
|-----|-------|-------|--------------|---------|--------|
| 411 | 22 mm | 1,0 m | 10 Stk./pcs. | 67652-2 | 68,22 |
| | | 2,7 m | | 67654-6 | 184,22 |

Die Fertigung erfolgt auf Fixlängen, Verschnitt wird mit berechnet, ohne Zuschneittkosten.
 Production takes place on fixed lengths, blended is charged with, without calculation of the cost of cutting.

passende Edelstahlschrauben siehe Abschnitt 12

suitable stainless steel screws see section 12

Beispiel: Edelstahl-Einschubprofil mit Nase und Edelstahl-Treppeninnenecke (siehe oben und vorherige Seite)
 example: stainless steel insert profile with nose and stainless steel stair inside corner (see above and previous page)



2. TREPPENKANTEN EDELSTAHL/ 2. STAIR NOSINGS STAINLESS STEEL

Rutschhemmungsklasse: R10 Prüfzeugnis kann angefordert werden.

slip resistance class: R10 certificate can be requested.

Edelstahl-Treppenkante mit profilierter Riffelung, matt, 1,5 mm Materialdicke

stair nosing out of stainless steel matt, with fluted ruffle, 1,5 mm material thickness

passende Edelstahlschrauben
 siehe Abschnitt 12/ suitable
 stainless steel screws see section 12

Profi-Pack à 10 Stück im Bund

professional packing à 10 pcs.

| L / l (m) | VE/unit | Art./ref. | €/Stk./pcs. |
|-----------|---------|-----------|-------------|
|-----------|---------|-----------|-------------|

SB incl. Dübel/ Edelstahlschrauben

self-service-pack with dowels/
stainless steel screws

| Art./ref. | €/Stk./pcs. |
|-----------|-------------|
|-----------|-------------|

154 Edelstahl-Treppenkante 20 x 40 x 1,5 mm, profilierte Riffelung, matt, gebohrt

stainless steel stair nosing 20 x 40 x 1,5 mm, fluted profile, matt, drilled



| | | | |
|-----|-----------|---------|--------|
| 1,0 | 10 | 61630-6 | 42,10 |
| 2,7 | Stk./pcs. | 61640-5 | 113,78 |

| | |
|---------|--------|
| 61635-1 | 44,60 |
| 61645-0 | 121,22 |

R10

201 Edelstahl-Treppenkante 40 x 40 x 1,5 mm, profilierte Riffelung, matt, gebohrt

stainless steel stair nosing 40 x 40 x 1,5 mm, fluted profile, matt, drilled



| | | | |
|-----|-----------|---------|--------|
| 1,0 | 10 | 61690-0 | 56,18 |
| 2,7 | Stk./pcs. | 61700-6 | 151,68 |

| | |
|---------|--------|
| 61695-5 | 58,68 |
| 61705-1 | 159,14 |

R10

202 Edelstahl-Treppenkante 30 x 30 x 1,5 mm, profilierte Riffelung, matt, gebohrt

stainless steel stair nosing 30 x 30 x 1,5 mm, fluted profile, matt, drilled

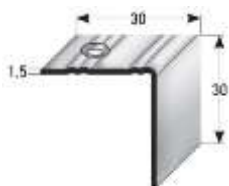

| | | | |
|-----|-----------|---------|--------|
| 1,0 | 10 | 61720-4 | 42,10 |
| 2,7 | Stk./pcs. | 61730-3 | 113,78 |

| | |
|---------|--------|
| 61725-9 | 44,60 |
| 61735-8 | 121,22 |

R10

203 Edelstahl-Treppenkante 20 x 30 x 1,5 mm, profilierte Riffelung, matt, gebohrt

stainless steel stair nosing 20 x 30 x 1,5 mm, fluted profile, matt, drilled

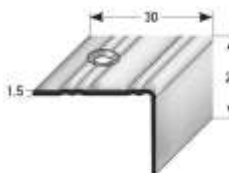

| | | | |
|-----|-----------|---------|-------|
| 1,0 | 10 | 61750-1 | 35,10 |
| 2,7 | Stk./pcs. | 61760-0 | 94,78 |

| | |
|---------|--------|
| 61755-6 | 37,58 |
| 61765-5 | 102,26 |

R10

204 Edelstahl-Treppenkante 10 x 30 x 1,5 mm, profilierte Riffelung, matt, gebohrt

stainless steel stair nosing 10 x 30 x 1,5 mm, fluted profile, matt, drilled

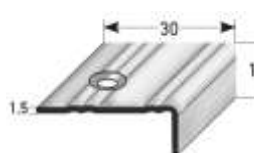

| | | | |
|-----|-----------|---------|-------|
| 1,0 | 10 | 61780-8 | 28,10 |
| 2,7 | Stk./pcs. | 61790-7 | 75,84 |

| | |
|---------|-------|
| 61785-3 | 30,58 |
| 61795-2 | 83,24 |

R10

- ungebohrte Profile & Längen bis 6,0 m auf Anfrage/ undrilled profiles and lengths up to 6,0 m on request
 - Werkstoff 1.4301 (V2A) / V4A auf Anfrage/ material 1.4301 (V2A) / V4A on request

- Qualität zu wählen ist die beste Art zu sparen -

choosing quality is the best way to save

2. TREPPENKANTEN EDELSTAHL/ 2. STAIR NOSINGS STAINLESS STEEL

Rutschhemmungsklasse: R10 Prüfzeugnis kann angefordert werden.

slip resistance class: R10 certificate can be requested.

Edelstahl-Treppenkante mit gefräster Riffelung - Zum Gegenstoßen von Bodenbelägen oder Beschichtungen bis 3mm, rutschhemmende Riffelung, Glatfläche matt, gekantet, gebohrt mit Senkung

stainless steel stair nosing with milled fluting - for installation with carpets up to 3mm, antislip fluting, smooth edge matt, edged, countersunk drilled

| L / l (m) | VE/unit | Art./ref. | €/Stk./pcs. |
|-----------|---------|-----------|-------------|
|-----------|---------|-----------|-------------|

206 Edelstahl-Treppenkante 20 x 40 x 3 mm, gefräste Riffelung, gekantet, gebohrt

stainless steel stair nosing 20 x 40 x 3 mm, milled fluting, edged, drilled



| | | | |
|-----|-------------|---------|--------|
| 1,0 | 1 Stk./pcs. | 60500-3 | 171,40 |
| 2,5 | | 60501-0 | 428,56 |

passende Edelstahlschrauben siehe Abschnitt 12
 suitable stainless steel screws see section 12

R10

207 Edelstahl-Treppenkante 30 x 30 x 3 mm, gefräste Riffelung, gekantet, gebohrt

stainless steel stair nosing 30 x 30 x 3 mm, milled fluting, edged, drilled

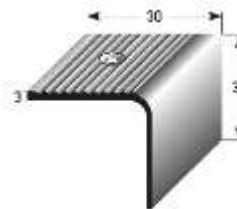

| | | | |
|-----|-------------|---------|--------|
| 1,0 | 1 Stk./pcs. | 60510-2 | 171,40 |
| 2,5 | | 60511-9 | 428,56 |

passende Edelstahlschrauben siehe Abschnitt 12
 suitable stainless steel screws see section 12

R10

208 Edelstahl-Treppenkante 28 x 50 x 3 mm, gefräste Riffelung, gekantet, gebohrt

stainless steel stair nosing 28 x 50 x 3 mm, milled fluting, edged, drilled



| | | | |
|-----|-------------|---------|--------|
| 1,0 | 1 Stk./pcs. | 60520-1 | 228,54 |
| 2,5 | | 60521-8 | 571,40 |

passende Edelstahlschrauben siehe Abschnitt 12
 suitable stainless steel screws see section 12

R10



Kante im Auslauf anphasen (zum Aufsetzen auf Bodenbelag)
 chamfering edges (to be installed on top of flooring)

| | |
|---------|---------|
| 22213-2 | 40,28/m |
|---------|---------|

Treppenkante Edelstahl V4A gezogen

drawn stainless steel stair nosing V4A

Profi-Pack à 10 Stück im Bund

professional packing à 10 pcs.

| L / l (m) | VE/unit | Art./ref. | €/Stk./pcs. |
|-----------|---------|-----------|-------------|
|-----------|---------|-----------|-------------|

SB incl. Dübel/ Edelstahlschrauben

self-service-pack with dowels/ stainless steel screws

| Art./ref. | €/Stk./pcs. |
|-----------|-------------|
|-----------|-------------|

438 Treppenkante 23 x 25 x 3,5 mm, Edelstahl V4A gezogen, gebohrt

drawn stainless steel stair nosing V4A 23 x 25 x 3,5 mm, drilled



| | | | | | |
|-----|--------------|---------|--------|---------|--------|
| 1,0 | 10 Stk./pcs. | 68250-9 | 120,62 | 68256-1 | 123,12 |
| 2,5 | | 68252-3 | 301,52 | 68258-5 | 308,96 |

2. TREPPENKANTEN EDELSTAHL/ 2. STAIR NOSINGS STAINLESS STEEL

Rutschhemmungsklasse: R12 Prüfzeugnis kann angefordert werden.

slip resistance class: R12 certificate can be requested.

3,5 mm-Edelstahlschrauben,
siehe Abschnitt 12

3,5 mm stainless steel screws,
see section 12

Edelstahl-Treppenkanten mit Prägelochung, matt gebürstet, gebohrt, mit Schutzfolie, VE 1 Stück

stainless steel stair nosings with embossed punching, 1,5 mm material thickness,
matt brushed, drilled, unit 1 pcs.

| Dimension (mm) | L / l (m) | Art./ref. | €/Stk./pcs. |
|----------------|-----------|-----------|-------------|
|----------------|-----------|-----------|-------------|

311 Treppenkante 10 x 30 x 1,5 mm mit Prägelochung, Edelstahl matt, gebohrt, mit Schutzfolie

stair nosing 10 x 30 x 1,5 mm with
embossed punching, stainless steel
matt, drilled, with protective film



| | | | |
|---------------|-------|---------|-------|
| 10 x 30 x 1,5 | 1,0 m | 65118-5 | 31,86 |
| | 2,5 m | 65120-8 | 79,70 |
| | 3,0 m | 65122-2 | 95,60 |

R12

312 Treppenkante 20 x 40 x 1,5 mm mit Prägelochung, Edelstahl matt, gebohrt, mit Schutzfolie

stair nosing 20 x 40 x 1,5 mm with
embossed punching, stainless steel
matt, drilled, with protective film



| | | | |
|---------------|-------|---------|--------|
| 20 x 40 x 1,5 | 1,0 m | 65128-4 | 52,36 |
| | 2,5 m | 65130-7 | 130,90 |
| | 3,0 m | 65132-1 | 157,08 |

R12

318 Treppenkante 25 x 60 x 1,5 mm mit Prägelochung, Edelstahl matt, gebohrt, mit Schutzfolie

stair nosing 25 x 60 x 1,5 mm with
embossed punching, stainless steel
matt, drilled, with protective film

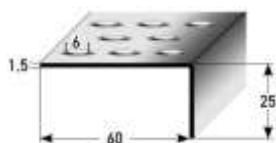

| | | | |
|---------------|-------|---------|--------|
| 25 x 60 x 1,5 | 1,0 m | 65158-1 | 78,52 |
| | 2,5 m | 65160-4 | 196,38 |
| | 3,0 m | 65162-8 | 235,64 |

R12

319 Treppenkante 25 x 80 x 1,5 mm mit Prägelochung, Edelstahl matt, gebohrt, mit Schutzfolie

stair nosing 25 x 80 x 1,5 mm with
embossed punching, stainless steel
matt, drilled, with protective film



| | | | |
|---------------|-------|---------|--------|
| 25 x 80 x 1,5 | 1,0 m | 65168-0 | 104,76 |
| | 2,5 m | 65170-3 | 261,84 |
| | 3,0 m | 65172-7 | 314,22 |

R12

320 Treppenkante 50 x 80 x 1,5 mm mit Prägelochung, Edelstahl matt, gebohrt, mit Schutzfolie

stair nosing 50 x 80 x 1,5 mm with
embossed punching, stainless steel
matt, drilled, with protective film

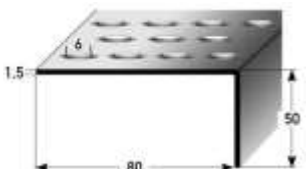

| | | | |
|---------------|-------|---------|--------|
| 50 x 80 x 1,5 | 1,0 m | 65178-9 | 129,70 |
| | 2,5 m | 65180-2 | 324,20 |
| | 3,0 m | 65182-6 | 389,02 |

R12

3,0 m-Ware ist nur per Spedition lieferbar (gesonderte Transportkosten)
3,0 m profiles are only available per forwarding agency (separate transport costs)

Lieferzeit nach vorheriger Absprache
delivery time by prior arrangement

2. TREPPENKANTEN EDELSTAHL/ 2. STAIR NOSINGS STAINLESS STEEL

Rutschhemmungsklasse: R12 Prüfzeugnis kann angefordert werden.

slip resistance class: R12 certificate can be requested.

Edelstahl-Treppenkanten mit Prägelochung und ANKER, matt gebürstet, mit Schutzfolie, VE 1 Stück, mit Stahlanker zum Einbetten in Beton

stainless steel stair nosings with embossed punching and anchor bolt, matt brushed, unit 1 pcs., with steel anchors for embedding in concrete

| Dimension (mm) | L / l (m) | Art./ref. | €/Stk./pcs. |
|----------------|-----------|-----------|-------------|
|----------------|-----------|-----------|-------------|

328 Treppenkante 10 x 30 x 1,5 mm mit Prägelochung und ANKER, Edelstahl matt

stair nosing 10 x 30 x 1,5 mm with embossed punching + anchor, stainless steel matt



| | | | |
|---------------|-------|---------|--------|
| 10 x 30 x 1,5 | 1,0 m | 65188-8 | 50,04 |
| | 2,5 m | 65190-1 | 125,16 |
| | 3,0 m | 65192-5 | 150,16 |

R12

5 Bolzen/ Laufmeter à ø 6 mm und 20 mm Länge
5 anchor bolt/ running meter à ø 6 mm and 20 mm length

329 Treppenkante 20 x 40 x 1,5 mm mit Prägelochung und ANKER, Edelstahl matt

stair nosing 20 x 40 x 1,5 mm with embossed punching + anchor, stainless steel matt



| | | | |
|---------------|-------|---------|--------|
| 20 x 40 x 1,5 | 1,0 m | 65198-7 | 70,56 |
| | 2,5 m | 65200-7 | 176,36 |
| | 3,0 m | 65202-1 | 211,62 |

R12

5 Bolzen/ Laufmeter à ø 6 mm und 20 mm Länge
5 anchor bolt/ running meter à ø 6 mm and 20 mm length

330 Treppenkante 25 x 60 x 1,5 mm mit Prägelochung und ANKER, Edelstahl matt

stair nosing 25 x 60 x 1,5 mm with embossed punching + anchor, stainless steel matt



| | | | |
|---------------|-------|---------|--------|
| 25 x 60 x 1,5 | 1,0 m | 65208-3 | 96,70 |
| | 2,5 m | 65210-6 | 241,82 |
| | 3,0 m | 65212-0 | 290,16 |

R12

5 Bolzen/ Laufmeter à ø 6 mm und 30 mm Länge
5 anchor bolt/ running meter à ø 6 mm and 30 mm length

331 Treppenkante 25 x 80 x 1,5 mm mit Prägelochung und ANKER, Edelstahl matt

stair nosing 25 x 80 x 1,5 mm with embossed punching + anchor, stainless steel matt



| | | | |
|---------------|-------|---------|--------|
| 25 x 80 x 1,5 | 1,0 m | 65238-0 | 122,92 |
| | 2,5 m | 65240-3 | 307,34 |
| | 3,0 m | 65242-7 | 368,78 |

R12

5 Bolzen/ Laufmeter à ø 6 mm und 30 mm Länge
5 anchor bolt/ running meter à ø 6 mm and 30 mm length

332 Treppenkante 50 x 80 x 1,5 mm mit Prägelochung und ANKER, Edelstahl matt

stair nosing 50 x 80 x 1,5 mm with embossed punching + anchor, stainless steel matt



| | | | |
|---------------|-------|---------|--------|
| 50 x 80 x 1,5 | 1,0 m | 65248-9 | 147,86 |
| | 2,5 m | 65250-2 | 369,66 |
| | 3,0 m | 65252-6 | 443,58 |

R12

5 Bolzen/ Laufmeter à ø 6 mm und 30 mm Länge
5 anchor bolt/ running meter à ø 6 mm and 30 mm length

3,0 m-Ware ist nur per Spedition lieferbar (gesonderte Transportkosten)
3,0 m profiles are only available per forwarding agency (separate transport costs)

Lieferzeit nach vorheriger Absprache/ delivery time by prior arrangement

2. TREPPENKANTEN EDELSTAHL/ 2. STAIR NOSINGS STAINLESS STEEL

Fertigung auf Fixlängen auf Anfrage möglich/ production of end length possible on request

Edelstahl-Treppenkanten Noppenprägung, matt gebürstet, mit Schutzfolie, VE 1 Stück

stainless steel stair nosings with nub embossing, matt brushed, unit 1 pcs.

| Noppenaußenmaß nub outside dimension | L / l (m) | Art./ref. | €/Stk./pcs. |
|---|-----------|-----------|-------------|
|---|-----------|-----------|-------------|

507 Treppenkante 20 x 40 x 1,5 mm mit 5 mm-Noppenprägung, Edelstahl matt, gebohrt

stair nosing 20 x 40 x 1,5 mm with 5 mm nub embossing, stainless steel matt, drilled

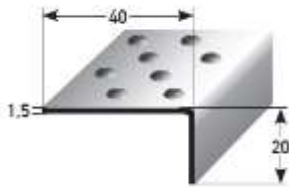

| | | | |
|------|-------|---------|--------|
| 5 mm | 1,0 m | 71632-7 | 52,36 |
| | 2,5 m | 71634-1 | 130,90 |

508 Treppenkante 25 x 60 x 1,5 mm mit 5 mm-Noppenprägung, Edelstahl matt, gebohrt

stair nosing 25 x 60 x 1,5 mm with 5 mm nub embossing, stainless steel matt, drilled

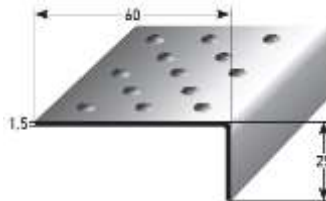

| | | | |
|------|-------|---------|--------|
| 5 mm | 1,0 m | 71636-5 | 78,52 |
| | 2,5 m | 71638-9 | 196,38 |

509 Treppenkante 20 x 40 x 1,5 mm mit 8 mm-Noppenprägung, Edelstahl matt, gebohrt

stair nosing 20 x 40 x 1,5 mm with 8 mm nub embossing, stainless steel matt, drilled

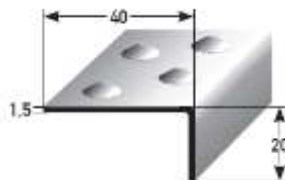

| | | | |
|------|-------|---------|--------|
| 8 mm | 1,0 m | 71640-2 | 52,36 |
| | 2,5 m | 71642-6 | 130,90 |

510 Treppenkante 25 x 60 x 1,5 mm mit 8 mm-Noppenprägung, Edelstahl matt, gebohrt

stair nosing 25 x 60 x 1,5 mm with 8 mm nub embossing, stainless steel matt, drilled

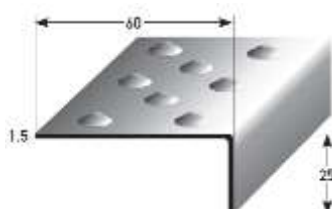

| | | | |
|------|-------|---------|--------|
| 8 mm | 1,0 m | 71644-0 | 78,52 |
| | 2,5 m | 71646-4 | 196,38 |

Befestigung mit Anker auf Anfrage erhältlich
 fixing with anchor bolt available on request

2. TREPPENKANTEN EDELSTAHL/ 2. STAIR NOSINGS STAINLESS STEEL

Fliesen-Treppenkante mit Noppenprägung, Edelstahl matt gebürstet, mit Schutzfolie, VE 1 Stück

tile stair nosing with nub embossing, stainless steel matt brushed, with protective film, 1 piece

Belaghöhe Innenmaß (h)
 flooring height inside dimension (h)

L / l (m)

Art./ref.

€/Stk./pcs.

523 Fliesen-Treppenkante 25 x 1,0 mm mit 5 mm-Noppenprägung, Edelstahl matt,

mit Dreieckstanzung

tile stair nosing 25 x 1,0 mm with 5 mm knob embossing, stainless steel matt, with triangular punching

| Belaghöhe Innenmaß (h) | L / l (m) | Art./ref. | €/Stk./pcs. |
|------------------------|-----------|-----------|-------------|
| 6 mm | 2,5 m | 71920-5 | 53,66 |
| 8 mm | | 71922-9 | 55,56 |

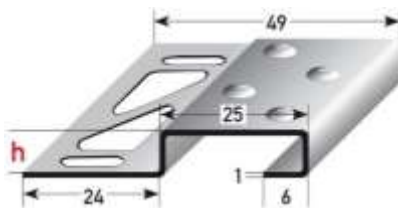

Seitliche Abdeckkappen und andere Höhen auf Anfrage erhältlich!

Lateral cover caps and other heights available on request!



3. WAND-, KANTENSCHUTZ- & SPEZIALPROFILE AUS EDELSTAHL, ALUMINIUM UND MESSING

3. WALL + CORNER PROTECTION + SPECIAL PROFILES
OUT OF STAINLESS STEEL + ALUMINIUM + BRASS

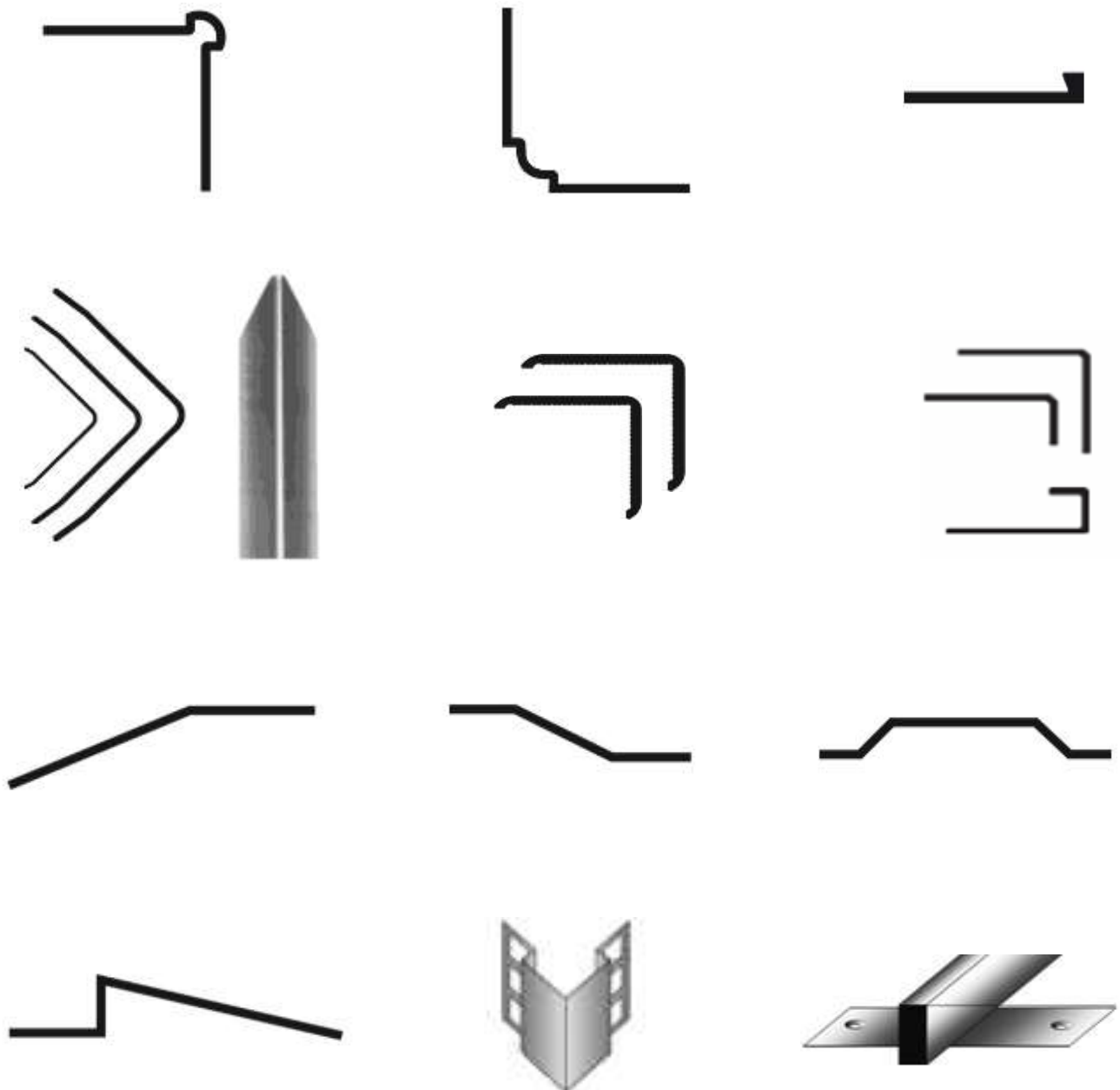

3. WAND-, KANTENSCHUTZ- & SPEZIALPROFILE/ 3. WALL+CORNER PROTECTION+SPECIAL PROFILES

Andere Eloxalfarben siehe Abschnitt 6, Lieferzeit 14 Tage/ Lieferzeit f. Pulverbeschichtet auf Anfrage / other anodized colours see section 6, delivery time 14 days/ delivery time for powder coating on request

| Wand- und Anstoßprofile aus Aluminium | | | |
|---|-----------|-----------|-------------|
| wall profiles and edge profile out of aluminium | | | |
| Farbe/colour | L / l (m) | Art./ref. | €/Stk./pcs. |

493 Wandprofil Außenecke 2 mm, Aluminium, ungebohrt

wall profile outside corner
2 mm, aluminium, undrilled

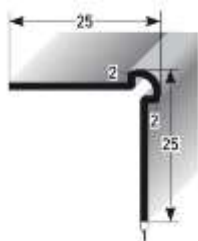

| | | | |
|--|-----|--|-------|
| silberfarbig silver | 2,7 | 71248-0 | 17,10 |
| edelstahlfarbig stainless steel coloured | | 71250-3 | 22,42 |
| Pulverbeschichtet nach RAL9016 Verkehrsweiß powder RAL9016 | | 71252-7 | 25,36 |
| Pulverbeschichtet nach RAL; Preis ab 150 lfm. powder RAL; price from 150 m | 2,7 | 71254-1 | 27,58 |
| | | Pulvern nach RAL unter 150 lfm. auf Anfrage powdered (RAL) less than 150 m on request | |

493 Wandprofil Außenecke 2 mm, Aluminium, mit Dreieckstanzung

wall profile outside corner
2 mm, aluminium, triangle
punching



| | | | |
|--|-----|--|-------|
| silberfarbig silver | 2,7 | 71650-1 | 19,46 |
| edelstahlfarbig stainless steel coloured | | 71652-5 | 27,58 |
| Pulverbeschichtet nach RAL9016 Verkehrsweiß powder RAL9016 | | 71654-9 | 27,76 |
| Pulverbeschichtet nach RAL; Preis ab 150 lfm. powder RAL; price from 150 m | 2,7 | 71656-3 | 29,98 |
| | | Pulvern nach RAL unter 150 lfm. auf Anfrage powdered (RAL) less than 150 m on request | |

511 Wandprofil Außenecke 3 mm, Aluminium, ungebohrt

wall profile outside corner
3 mm, aluminium, undrilled

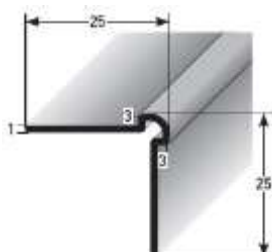

| | | | |
|--|-----|--|-------|
| silberfarbig silver | 2,7 | 71660-0 | 17,12 |
| edelstahlfarbig stainless steel coloured | | 71662-4 | 25,24 |
| Pulverbeschichtet nach RAL9016 Verkehrsweiß powder RAL9016 | | 71664-8 | 25,40 |
| Pulverbeschichtet nach RAL; Preis ab 150 lfm. powder RAL; price from 150 m | 2,7 | 71666-2 | 27,60 |
| | | Pulvern nach RAL unter 150 lfm. auf Anfrage powdered (RAL) less than 150 m on request | |

511 Wandprofil Außenecke 3 mm, Aluminium, mit Dreieckstanzung

wall profile outside corner
3 mm, aluminium, triangle
punching

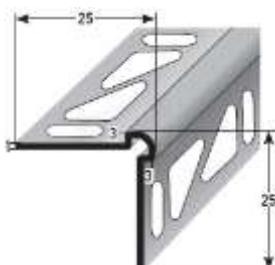

| | | | |
|--|-----|--|-------|
| silberfarbig silver | 2,7 | 71670-9 | 20,54 |
| edelstahlfarbig stainless steel coloured | | 71672-3 | 28,66 |
| Pulverbeschichtet nach RAL9016 Verkehrsweiß powder RAL9016 | | 71674-7 | 28,82 |
| Pulverbeschichtet nach RAL; Preis ab 150 lfm. powder RAL; price from 150 m | 2,7 | 71676-1 | 31,02 |
| | | Pulvern nach RAL unter 150 lfm. auf Anfrage powdered (RAL) less than 150 m on request | |

3. WAND-, KANTENSCHUTZ- & SPEZIALPROFILE/ 3. WALL+CORNER PROTECTION+SPECIAL PROFILES

Andere Eloxalfarben siehe Abschnitt 6, Lieferzeit 14 Tage/ Lieferzeit f. Pulverbeschichtet auf Anfrage / other anodized colours see section 6, delivery time 14 days/ delivery time for powder coating on request

| Wand- und Anstoßprofile aus Aluminium | | | |
|---|-----------|-----------|-------------|
| wall profiles and edge profile out of aluminium | | | |
| Farbe/colour | L / l (m) | Art./ref. | €/Stk./pcs. |

494 Wandprofil Innenecke 2 mm, Aluminium, ungebohrt

wall profile inside corner
2 mm, aluminium, undrilled



| | | | |
|--|-----|---------|-------|
| silberfarbig silver | 2,7 | 71268-8 | 18,10 |
| edelstahlfarbig stainless steel coloured | | 71270-1 | 21,86 |
| Pulverbeschichtet nach RAL9016 Verkehrsweiß / powder RAL9016 | | 71272-5 | 25,06 |
| Pulverbeschichtet nach RAL; Preis ab 150 lfm. powder RAL; price from 150 m | 2,7 | 71274-9 | 27,30 |
| Pulvern nach RAL unter 150 lfm. auf Anfrage powdered (RAL) less than 150 m on request | | | |

494 Wandprofil Innenecke 2 mm, Aluminium, mit Dreieckstanzung

wall profile inside corner 2 mm,
aluminium, triangle punching



| | | | |
|--|-----|---------|-------|
| silberfarbig silver | 2,7 | 71680-8 | 20,50 |
| edelstahlfarbig stainless steel coloured | | 71682-2 | 26,94 |
| Pulverbeschichtet nach RAL9016 Verkehrsweiß / powder RAL9016 | | 71684-6 | 27,42 |
| Pulverbeschichtet nach RAL; Preis ab 150 lfm. powder RAL; price from 150 m | 2,7 | 71686-0 | 29,66 |
| Pulvern nach RAL unter 150 lfm. auf Anfrage powdered (RAL) less than 150 m on request | | | |

512 Wandprofil Innenecke 3 mm, Aluminium, ungebohrt

wall profile inside corner
3 mm, aluminium, undrilled



| | | | |
|--|-----|---------|-------|
| silberfarbig silver | 2,7 | 71690-7 | 18,12 |
| edelstahlfarbig stainless steel coloured | | 71692-1 | 24,90 |
| Pulverbeschichtet nach RAL9016 Verkehrsweiß / powder RAL9016 | | 71694-5 | 25,08 |
| Pulverbeschichtet nach RAL; Preis ab 150 lfm. powder RAL; price from 150 m | 2,7 | 71696-9 | 27,32 |
| Pulvern nach RAL unter 150 lfm. auf Anfrage powdered (RAL) less than 150 m on request | | | |

512 Wandprofil Innenecke 3 mm, Aluminium, mit Dreieckstanzung

wall profile inside corner 3 mm,
aluminium, triangle punching



| | | | |
|--|-----|---------|-------|
| silberfarbig silver | 2,7 | 71700-3 | 21,54 |
| edelstahlfarbig stainless steel coloured | | 71702-7 | 28,30 |
| Pulverbeschichtet nach RAL9016 Verkehrsweiß / powder RAL9016 | | 71704-1 | 28,50 |
| Pulverbeschichtet nach RAL; Preis ab 150 lfm. powder RAL; price from 150 m | 2,7 | 71706-5 | 30,74 |
| Pulvern nach RAL unter 150 lfm. auf Anfrage powdered (RAL) less than 150 m on request | | | |

495 Anstoßprofil 2 mm, Aluminium, ungebohrt

edge profile 2 mm, aluminium
anodized, undrilled



| | | | |
|--|-----|---------|-------|
| silberfarbig silver | 2,7 | 71310-4 | 12,44 |
| edelstahlfarbig stainless steel coloured | | 71312-8 | 15,42 |
| Pulverbeschichtet nach RAL9016 Verkehrsweiß / powder RAL9016 | | 71314-2 | 19,50 |
| Pulverbeschichtet nach RAL; Preis ab 150 lfm. powder RAL; price from 150 m | 2,7 | 71316-6 | 21,74 |
| Pulvern nach RAL unter 150 lfm. auf Anfrage powdered (RAL) less than 150 m on request | | | |

3. WAND-, KANTENSCHUTZ- & SPEZIALPROFILE/ 3. WALL+CORNER PROTECTION+SPECIAL PROFILES

Andere Eloxalfarben siehe Abschnitt 6, Lieferzeit 14 Tage/ Lieferzeit f. Pulverbeschichtet auf Anfrage / other anodized colours see section 6, delivery time 14 days/ delivery time for powder coating on request

| Eckschutzwinkel ohne Spitze aus Aluminium | | | | | |
|---|-----------|-----------------------------|-------------|-------------------|-------------|
| corner protection angles without tip out of Aluminium | | | | | |
| Farbe/colour | L / l (m) | selbstklebend self-adhesive | €/Stk./pcs. | ohne alles/ plain | €/Stk./pcs. |

337 Eckschutzwinkel 20 x 20 x 1,8 mm, ohne Spitze, Aluminium

corner protection angle 20 x 20 x 1,8 mm, without tip, aluminium

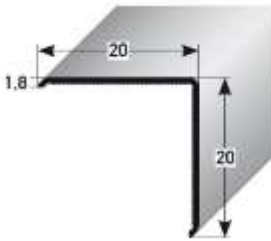

| | | | | | |
|--|------|---------|-------|---------|-------|
| silberfarbig silver | 1,0 | 65810-8 | 10,50 | 65792-7 | 6,52 |
| | 1,25 | 65812-2 | 13,10 | 65794-1 | 8,14 |
| | 2,5 | 65814-6 | 26,18 | 65796-5 | 16,30 |
| edelstahlfarbig Feinschliff fine-honed stainless steel coloured | 1,0 | 65816-0 | 15,80 | 65798-9 | 11,84 |
| | 1,25 | 65818-4 | 19,74 | 65800-9 | 14,80 |
| | 2,5 | 65820-7 | 39,46 | 65802-3 | 29,62 |
| Pulverbeschichtet nach RAL9016 Verkehrsweiß powder RAL9016 | 1,0 | 65834-4 | 13,38 | 65828-3 | 9,60 |
| | 1,25 | 65836-8 | 16,74 | 65830-6 | 12,02 |
| | 2,5 | 65838-2 | 33,44 | 65832-0 | 24,02 |
| Pulverbeschichtet nach RAL; Preis ab 150 lfm. powder RAL; price from 150m | 1,0 | 65822-1 | 16,84 | 65804-7 | 12,90 |
| | 1,25 | 65824-5 | 21,08 | 65806-1 | 16,12 |
| | 2,5 | 65826-9 | 42,14 | 65808-5 | 32,28 |
| Pulvern nach RAL unter 150 lfm. auf Anfrage powdered (RAL) less than 150m on request | | | | | |

338 Eckschutzwinkel 25 x 25 x 1,9 mm, ohne Spitze, Aluminium

corner protection angle 25 x 25 x 1,9 mm, without tip, aluminium

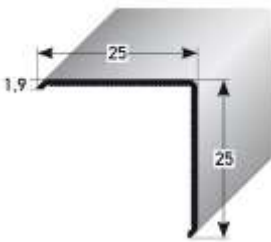

| | | | | | |
|--|------|---------|-------|---------|-------|
| silberfarbig silver | 1,0 | 65888-7 | 11,76 | 65870-2 | 7,86 |
| | 1,25 | 65890-0 | 14,74 | 65872-6 | 9,82 |
| | 2,5 | 65892-4 | 29,48 | 65874-0 | 19,62 |
| edelstahlfarbig Feinschliff fine-honed stainless steel coloured | 1,0 | 65894-8 | 16,84 | 65876-4 | 12,90 |
| | 1,25 | 65896-2 | 21,08 | 65878-8 | 16,12 |
| | 2,5 | 65898-6 | 42,10 | 65880-1 | 32,26 |
| Pulverbeschichtet nach RAL9016 Verkehrsweiß powder RAL9016 | 1,0 | 65912-9 | 14,54 | 65906-8 | 10,76 |
| | 1,25 | 65914-3 | 18,16 | 65908-2 | 13,44 |
| | 2,5 | 65916-7 | 36,30 | 65910-5 | 26,92 |
| Pulverbeschichtet nach RAL; Preis ab 150 lfm. powder RAL; price from 150m | 1,0 | 65900-6 | 18,48 | 65882-5 | 14,52 |
| | 1,25 | 65902-0 | 23,10 | 65884-9 | 18,14 |
| | 2,5 | 65904-4 | 46,18 | 65886-3 | 36,32 |
| Pulvern nach RAL unter 150 lfm. auf Anfrage powdered (RAL) less than 150m on request | | | | | |

503 Eckschutzwinkel 30 x 30 x 1,9 mm, ohne Spitze, Aluminium

corner protection angle 30 x 30 x 1,9 mm, without tip, aluminium

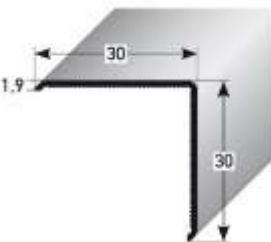

| | | | | | |
|--|------|---------|-------|---------|-------|
| silberfarbig silver | 1,0 | 71434-7 | 13,36 | 71410-1 | 9,44 |
| | 1,25 | 71436-1 | 16,72 | 71412-5 | 11,82 |
| | 2,5 | 71438-5 | 33,40 | 71414-9 | 23,60 |
| edelstahlfarbig Feinschliff fine-honed stainless steel coloured | 1,0 | 71440-8 | 19,40 | 71416-3 | 15,48 |
| | 1,25 | 71442-2 | 24,28 | 71418-7 | 19,36 |
| | 2,5 | 71444-6 | 48,50 | 71420-0 | 38,70 |
| Pulverbeschichtet nach RAL9016 Verkehrsweiß powder RAL9016 | 1,0 | 71446-0 | 16,84 | 71422-4 | 12,94 |
| | 1,25 | 71448-4 | 21,08 | 71424-8 | 16,18 |
| | 2,5 | 71450-7 | 42,12 | 71426-2 | 32,34 |
| Pulverbeschichtet nach RAL; Preis ab 150 lfm. powder RAL; price from 150m | 1,0 | 71452-1 | 21,34 | 71428-6 | 17,42 |
| | 1,25 | 71454-5 | 26,66 | 71430-9 | 21,78 |
| | 2,5 | 71456-9 | 53,36 | 71432-3 | 43,56 |
| Pulvern nach RAL unter 150 lfm. auf Anfrage powdered (RAL) less than 150m on request | | | | | |

3. WAND-, KANTENSCHUTZ- & SPEZIALPROFILE/ 3. WALL+CORNER PROTECTION+SPECIAL PROFILES

Andere Abmaße auf Anfrage
other dimensions on demand

| Eckschutzwinkel mit Spitze aus Edelstahl (V2A) | | | | | |
|--|-----------|--------------------------------|-------------|---------------------|-------------|
| corner protection angles with tip out of stainless steel (V2A) | | | | | |
| Material/material | L / l (m) | selbstklebend self-adhesive | €/Stk./pcs. | ohne alles plain | €/Stk./pcs. |

481 Eckschutzwinkel 20 x 20 x 1,0 mm, Edelstahl matt, dreifach gekantet

corner protection angle
20 x 20 x 1,0 mm, stainless steel
matt, triple edged

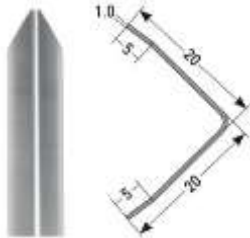

| | | | | | |
|--|------|---------|-------|---------|-------|
| Edelstahl matt stainless steel matt | 1,0 | 70958-9 | 14,46 | 70966-4 | 12,80 |
| | 1,25 | 70960-2 | 18,06 | 70968-8 | 16,00 |
| | 1,5 | 70962-6 | 21,68 | 70970-1 | 19,22 |
| | 2,5 | 70964-0 | 36,08 | 70972-5 | 32,02 |

**Andere Eloxalfarben siehe
Abschnitt 6, Lieferzeit 14 Tage**
other anodized colours see
section 6, delivery time 14 days

| Eckschutzwinkel mit Spitze aus Edelstahl (V2A) und Aluminium | | | | | | |
|--|-----------|--------------------------------|--------------------------------|-------------|----------------------|-------------|
| corner protection angles with tip out of stainless steel (V2A) and aluminium | | | | | | |
| Dicke (mm)/ thickness | L / l (m) | selbstklebend self-adhesive | gebohrt siehe* drilled see* | €/Stk./pcs. | ohne alles/ plain | €/Stk./pcs. |

209 Eckschutzwinkel 30 x 30 mm, dreifach gekantet

corner protection angle
30 x 30 mm, triple edged

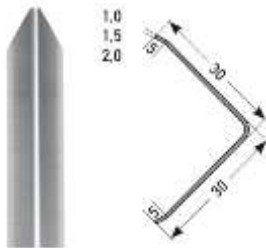

*** Bitte Bohrtyp
angeben:**

- 01 einseitig seitlich
- 02 einseitig mittig
- 03 wechselseitig seitlich
- 04 wechselseitig mittig
- 05 im Knick

*** Please specify drill holes:**

- 01 single sided laterally
- 02 single sided centrally
- 03 alternating sides laterally
- 04 alternating sides centrally
- 05 in edge

| | | | | | | | |
|--|--------|---------|---------|---------|---------|---------|-------|
| Edelstahl matt stainless steel matt | 1,0 mm | 1,0 | 60824-0 | 60812-7 | 21,68 | 60800-4 | 19,22 |
| | | 1,25 | 60825-7 | 60813-4 | 27,04 | 60801-1 | 23,98 |
| | | 1,5 | 66238-9 | 66236-5 | 32,48 | 66234-1 | 28,82 |
| | 1,5 mm | 2,5 | 60826-4 | 60814-1 | 54,14 | 60802-8 | 48,08 |
| | | 1,0 | 60828-8 | 60816-5 | 32,46 | 60804-2 | 28,84 |
| | | 1,25 | 60829-5 | 60817-2 | 40,58 | 60805-9 | 36,04 |
| | 2,0 mm | 1,5 | 66244-0 | 66242-6 | 48,70 | 66240-2 | 43,30 |
| | | 2,5 | 60830-1 | 60818-9 | 81,12 | 60806-6 | 72,10 |
| | | 1,0 | 60832-5 | 60820-2 | 43,26 | 60808-0 | 38,46 |
| Alu walzblank Alu mill finish | 1,5 mm | 1,25 | 60833-2 | 60821-9 | 54,12 | 60809-7 | 48,08 |
| | | 1,5 | 66250-1 | 66248-8 | 64,88 | 66246-4 | 57,66 |
| | | 2,5 | 60834-9 | 60822-6 | 108,18 | 60810-3 | 96,06 |
| | 2,0 mm | 1,0 | 60960-5 | 60958-2 | 15,02 | 60956-8 | 9,82 |
| | | 1,5 | 66258-7 | 66256-3 | 22,52 | 66254-9 | 14,72 |
| | | 2,5 | 60961-2 | 60959-9 | 37,54 | 60957-5 | 24,58 |
| 2,0 mm | 1,0 | 60680-2 | 60970-4 | 17,80 | 60968-1 | 13,08 | |
| | 1,5 | 66264-8 | 66262-4 | 26,68 | 66260-0 | 19,62 | |
| | 2,5 | 60690-1 | 60971-1 | 44,48 | 60969-8 | 32,58 | |
| Alu silber elox. silver anodized | 1,5 mm | 1,0 | 60966-7 | 60964-3 | 20,00 | 60962-9 | 14,80 |
| | | 1,5 | 66270-9 | 66268-6 | 29,98 | 66266-2 | 22,22 |
| | | 2,5 | 60967-4 | 60965-0 | 49,90 | 60963-6 | 37,00 |
| | 2,0 mm | 1,0 | 60976-6 | 60974-2 | 22,76 | 60972-8 | 17,98 |
| | | 1,5 | 66276-1 | 66274-7 | 34,14 | 66272-3 | 26,96 |
| | | 2,5 | 60977-3 | 60975-9 | 56,86 | 60973-5 | 44,98 |

passende Schrauben siehe Abschnitt 12
suitable screws see section 12

3. WAND-, KANTENSCHUTZ- & SPEZIALPROFILE/ 3. WALL+CORNER PROTECTION+SPECIAL PROFILES

Andere Eloxalfarben siehe Abschnitt 6, Lieferzeit 14 Tage
 other anodized colours see section 6, delivery time 14 days

Andere Abmaße auf Anfrage
 other dimensions on demand

| Eckschutzwinkel mit Spitze aus Edelstahl (V2A) | | | | | | |
|--|-----------|-----------------------------|-----------------------------|-------------|-------------------|-------------|
| corner protection angles with tip out of stainless steel (V2A) | | | | | | |
| Dicke (mm)/ thickness | L / l (m) | selbstklebend self-adhesive | gebohrt siehe* drilled see* | €/Stk./pcs. | ohne alles/ plain | €/Stk./pcs. |

210 Eckschutzwinkel 40 x 40 mm, dreifach gekantet

corner protection angle 40 x 40 mm, triple edged

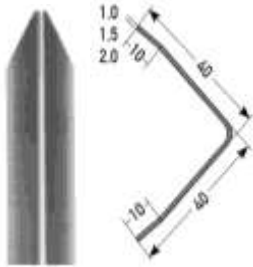

* Bitte Bohrtyp angeben:

- 01 einseitig seitlich
- 02 einseitig mittig
- 03 wechselseitig seitlich
- 04 wechselseitig mittig
- 05 im Knick

* Please specify drill holes:
 01 single sided laterally
 02 single sided centrally
 03 alternating sides laterally
 04 alternating sides centrally
 05 in edge

| Edelstahl matt stainless steel matt | Dicke (mm) | L / l (m) | | €/Stk./pcs. | | | | |
|-------------------------------------|------------------|-----------|---------|---------------|---------|------------|---------|--------|
| | | 1,0 | 1,5 | selbstklebend | gebohrt | ohne alles | | |
| Edelstahl matt | 1,0 mm | 1,0 | 60185-2 | 60848-6 | 28,84 | 60836-3 | 26,44 | |
| | | 1,25 | 60190-6 | 60849-3 | 36,04 | 60837-0 | 33,00 | |
| | | 1,5 | 66284-6 | 66282-2 | 43,30 | 66280-8 | 39,66 | |
| | Edelstahl matt | 1,5 mm | 2,5 | 60200-2 | 60850-9 | 72,10 | 60838-7 | 66,04 |
| | | | 1,0 | 60165-4 | 60852-3 | 43,26 | 60840-0 | 39,66 |
| | | | 1,25 | 60170-8 | 60853-0 | 54,12 | 60841-7 | 49,54 |
| Edelstahl matt | | 1,5 mm | 1,5 | 66290-7 | 66288-4 | 64,88 | 66286-0 | 59,50 |
| | | | 2,5 | 60180-7 | 60854-7 | 108,16 | 60842-4 | 99,10 |
| | | | 1,0 | 60650-5 | 60856-1 | 57,72 | 60844-8 | 52,86 |
| | Edelstahl matt | 2,0 mm | 1,25 | 60655-0 | 60857-8 | 72,12 | 60845-5 | 66,08 |
| | | | 1,5 | 66296-9 | 66294-5 | 86,54 | 66292-1 | 79,30 |
| | | | 2,5 | 60660-4 | 60858-5 | 144,20 | 60846-2 | 132,16 |
| Alu walzblank alu mill finish | | 1,5 mm | 1,0 | 60982-7 | 60980-3 | 17,80 | 60978-0 | 12,42 |
| | | | 1,5 | 66304-1 | 66302-7 | 26,68 | 66300-3 | 18,64 |
| | | | 2,5 | 60983-4 | 60981-0 | 44,48 | 60979-7 | 31,08 |
| | Alu walzblank | 2,0 mm | 1,0 | 60992-6 | 60990-2 | 20,50 | 60665-9 | 16,64 |
| | | | 1,5 | 66310-2 | 66308-9 | 30,72 | 66306-5 | 24,96 |
| | | | 2,5 | 60993-3 | 60991-9 | 51,20 | 60675-8 | 41,66 |
| Alu silber elox. silver anodized | 1,5 mm | 1,0 | 60988-9 | 60986-5 | 20,50 | 60984-1 | 19,02 | |
| | | 1,5 | 66316-4 | 66314-0 | 30,72 | 66312-6 | 28,52 | |
| | | 2,5 | 60989-6 | 60987-2 | 51,20 | 60985-8 | 47,46 | |
| | Alu silber elox. | 2,0 mm | 1,0 | 60998-8 | 60996-4 | 24,36 | 60994-0 | 23,20 |
| | | | 1,5 | 66322-5 | 66320-1 | 36,54 | 66318-8 | 34,80 |
| | | | 2,5 | 60999-5 | 60997-1 | 60,82 | 60995-7 | 58,08 |

211 Eckschutzwinkel 50 x 50 mm, Edelstahl matt, dreifach gekantet

corner protection angle 50 x 50 mm, stainless steel matt, triple edged

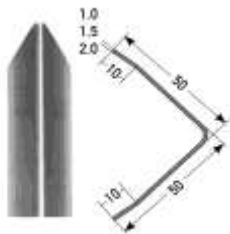

* Bitte Bohrtyp angeben:

- 01 einseitig seitlich
- 02 einseitig mittig
- 03 wechselseitig seitlich
- 04 wechselseitig mittig
- 05 im Knick

* Please specify drill holes:
 01 single sided laterally
 02 single sided centrally
 03 alternating sides laterally
 04 alternating sides centrally
 05 in edge

| Edelstahl matt stainless steel matt | Dicke (mm) | L / l (m) | | €/Stk./pcs. | | | | |
|-------------------------------------|----------------|-----------|---------|---------------|---------|------------|---------|--------|
| | | 1,0 | 1,5 | selbstklebend | gebohrt | ohne alles | | |
| Edelstahl matt | 1,0 mm | 1,0 | 60896-7 | 60884-4 | 36,06 | 60872-1 | 33,02 | |
| | | 1,25 | 60897-4 | 60885-1 | 45,04 | 60873-8 | 41,26 | |
| | | 1,5 | 66330-0 | 66328-7 | 54,12 | 66326-3 | 49,54 | |
| | Edelstahl matt | 1,5 mm | 2,5 | 60898-1 | 60886-8 | 90,10 | 60874-5 | 82,54 |
| | | | 1,0 | 60900-1 | 60888-2 | 54,12 | 60876-9 | 49,62 |
| | | | 1,25 | 60901-8 | 60889-9 | 67,64 | 60877-6 | 61,98 |
| Edelstahl matt | | 2,0 mm | 1,5 | 66336-2 | 66334-8 | 81,20 | 66332-4 | 74,40 |
| | | | 2,5 | 60902-5 | 60890-5 | 135,20 | 60878-3 | 123,90 |
| | | | 1,0 | 60904-9 | 60892-9 | 72,12 | 60880-6 | 66,08 |
| Edelstahl matt | 2,0 mm | 1,25 | 60905-6 | 60893-6 | 90,14 | 60881-3 | 82,58 | |
| | | 1,5 | 66342-3 | 66340-9 | 108,20 | 66338-6 | 99,10 | |
| | | 2,5 | 60906-3 | 60894-3 | 180,30 | 60882-0 | 165,18 | |

Andere Gradzahlen auf Anfrage erhältlich! Other degree values on request!

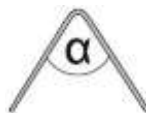

3. WAND-, KANTENSCHUTZ- & SPEZIALPROFILE/ 3. WALL+CORNER PROTECTION+SPECIAL PROFILES

Andere Abmaße auf Anfrage
 other dimensions on demand

| Edelstahl-Abkantprofile, matt gebürstet, mit Schutzfolie | | | | |
|---|-----------|------------|-----------|-------------|
| stainless steel edge profiles, matt brushed, with protective foil | | | | |
| Koffernr./ case no. | L / l (m) | AxBxC (mm) | Art./ref. | €/Stk./pcs. |

212-214 Deko-Winkel 1,5 / 2,0 / 3,0 mm, Edelstahl matt, ungebohrt

deco-angle 1,5 / 2,0 / 3,0 mm
 stainless steel matt, undrilled

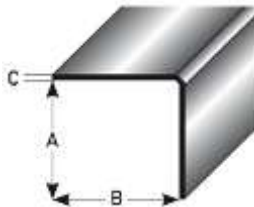

| | | | | |
|-----|-------|---------------|---------|--------|
| 212 | 2,5 m | 20 x 20 x 1,5 | 60210-1 | 54,14 |
| 213 | | 30 x 30 x 1,5 | 60220-0 | 81,06 |
| 214 | | 40 x 40 x 1,5 | 60230-9 | 108,16 |
| 213 | | 30 x 30 x 2,0 | 60430-3 | 108,14 |
| 214 | | 40 x 40 x 2,0 | 60440-2 | 144,20 |
| 214 | | 40 x 40 x 3,0 | 60470-9 | 216,26 |

Bohrung oder selbstklebend auf Anfrage
 drill holes or self adhesive on request

215- 217 Deko-L-Winkel 1,5 / 2,0 mm, Edelstahl matt, ungebohrt

deco-L-angle 1,5 / 2,0 mm,
 stainless steel matt, undrilled

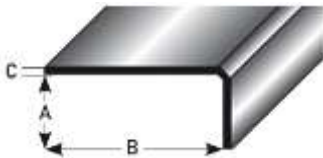

| | | | | |
|-----|-------|---------------|---------|--------|
| 215 | 2,5 m | 15 x 30 x 1,5 | 60240-8 | 60,86 |
| 216 | | 20 x 40 x 1,5 | 60250-7 | 81,06 |
| 217 | | 30 x 50 x 1,5 | 60260-6 | 108,16 |
| 216 | | 20 x 40 x 2,0 | 60450-1 | 108,14 |
| 217 | | 30 x 50 x 2,0 | 60460-0 | 144,20 |

Bohrung oder selbstklebend auf Anfrage
 drill holes or self adhesive on request

227 Ausgleichsprofil mit zwei Befestigungsschenkel, Edelstahl matt, gebohrt

level compensation profile with two
 attachment flanges, stainless steel matt,
 drilled

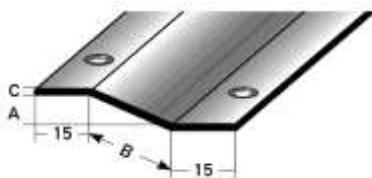

| | | | |
|-------|---------------|---------|--------|
| 2,5 m | 8 x 30 x 1,0 | 60330-6 | 73,14 |
| | 10 x 30 x 1,0 | 60340-5 | 78,34 |
| | 13 x 35 x 1,5 | 60350-4 | 108,16 |
| | 15 x 40 x 1,5 | 60360-3 | 121,70 |
| | 22 x 55 x 1,5 | 60370-2 | 148,70 |
| | 13 x 35 x 2,0 | 60480-8 | 144,20 |
| | 15 x 40 x 2,0 | 60490-7 | 162,24 |
| | 20 x 80 x 3,0 | 60491-4 | 222,30 |

218- 222 477 Einschubprofile, Edelstahl matt, gebohrt

insert profile, stainless steel matt,
 drilled

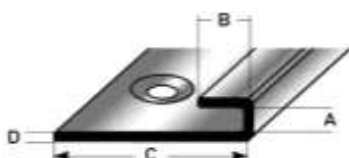

| AxBxCxD (mm) | | | | |
|--------------|-------|--------------------|---------|-------|
| 477 | 2,5 m | 5 x 5 x 34 x 1,0 | 60268-2 | 32,22 |
| 218 | | 8 x 8 x 34 x 1,0 | 60270-5 | 35,82 |
| 219 | | 10 x 10 x 34 x 1,0 | 60280-4 | 44,70 |
| 220 | | 13 x 10 x 34 x 1,0 | 60290-3 | 58,14 |
| 221 | | 15 x 10 x 34 x 1,0 | 60300-9 | 67,02 |
| 222 | | 22 x 10 x 34 x 1,0 | 60310-8 | 72,74 |

3. WAND-, KANTENSCHUTZ- & SPEZIALPROFILE/ 3. WALL+CORNER PROTECTION+SPECIAL PROFILES

| Miniwinkel, profiliert, ungebohrt, Sichtseite außen | | | | | |
|--|-----------|-----------|----------|-----------|-----|
| mini angle profiles, undrilled, visible side outside | | | | | |
| Material/material | L / l (m) | m/VE/unit | AxBxC mm | Art./ref. | €/m |

235 Miniwinkel gleichschenklig, Innenradius 0,3 mm, außen Rundkante, ungebohrt

mini angle profile, equal size sides, inside radius 0,3 mm, round edge, undrilled

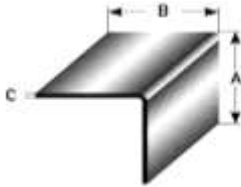

| | | | | | |
|--------------------------------------|-----|------|---------------|---------|-------|
| Edelstahl matt/ stainless steel matt | 2,7 | 27 m | 10 x 10 x 1,0 | 44800-6 | 9,68 |
| Edelstahl matt/ stainless steel matt | | | 10 x 10 x 1,5 | 44802-0 | 10,96 |
| Messing poliert/ brass polished | | | 10 x 10 x 1,2 | 44804-4 | 10,70 |
| Edelstahl matt/ stainless steel matt | 2,7 | 27 m | 15 x 15 x 1,0 | 44806-8 | 7,72 |
| Edelstahl matt/ stainless steel matt | | | 15 x 15 x 1,5 | 44808-2 | 14,30 |
| Messing poliert/ brass polished | | | 15 x 15 x 1,0 | 44810-5 | 14,84 |
| Edelstahl matt/ stainless steel matt | 2,7 | 27 m | 20 x 20 x 1,0 | 44812-9 | 8,70 |
| Edelstahl matt/ stainless steel matt | | | 20 x 20 x 1,5 | 44814-3 | 18,08 |
| Messing poliert/ brass polished | | | 20 x 20 x 1,0 | 44816-7 | 20,26 |

236 Miniwinkel ungleichschenklig, Innenradius 0,3 mm, außen Rundkante, ungebohrt

mini angle profile, different size sides, inside radius 0,3 mm, round edge, undrilled

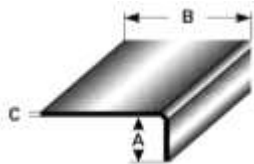

| | | | | | |
|---|-----|------|---------------|---------|-------|
| Edelstahl matt/ stainless steel matt | 2,7 | 27 m | 3,5x16,5x1,0 | 44818-1 | 9,38 |
| Messing poliert/ brass polished | | | 3,5x16,5x1,2 | 44820-4 | 10,42 |
| Edelstahl matt/ stainless steel matt | 2,7 | 27 m | 3 x 25 x 1,0 | 44822-8 | 7,72 |
| Messing poliert/ brass polished | | | 3 x 25 x 1,0 | 44824-2 | 14,84 |
| Edelstahl matt/ stainless steel matt | 2,7 | 27 m | 2,5x33,5x1,0 | 44826-6 | 8,70 |
| Edelstahl matt/ stainless steel matt | | | 3 x 34 x 1,0 | 44828-0 | 8,70 |
| Messing poliert/ brass polished | | | 3 x 34 x 1,0 | 44830-3 | 20,26 |
| Edelstahl matt/ stainless steel matt | 2,7 | 27 m | 4 x 24 x 1,5 | 44832-7 | 14,30 |
| Edelstahl matt/ stainless steel matt | 2,7 | 27 m | 5 x 15 x 1,0 | 44834-1 | 9,68 |
| Edelstahl matt/ stainless steel matt | | | 5 x 15 x 1,5 | 44836-5 | 10,96 |
| Messing poliert/ brass polished | | | 5 x 15 x 1,2 | 44838-9 | 10,70 |
| Edelstahl matt/ stainless steel matt | 2,7 | 27 m | 5 x 22 x 1,0 | 44840-2 | 7,72 |
| Edelstahl matt/ stainless steel matt | | | 5 x 22 x 1,5 | 44842-6 | 14,30 |
| Messing poliert/ brass polished | | | 5 x 22 x 1,0 | 44844-0 | 14,84 |
| Edelstahl matt/ stainless steel matt | 2,7 | 27 m | 5 x 32 x 1,0 | 44846-4 | 8,70 |
| Edelstahl matt/ stainless steel matt | | | 5 x 32 x 1,5 | 44848-8 | 18,08 |
| Messing poliert/ brass polished | | | 5 x 32 x 1,0 | 44850-1 | 20,26 |
| Edelstahl matt/ stainless steel matt | 2,7 | 27 m | 6 x 21 x 1,0 | 44852-5 | 7,72 |
| Edelstahl matt/ stainless steel matt | | | 6 x 21 x 1,5 | 44854-9 | 14,30 |
| Messing poliert/ brass polished | | | 6 x 21 x 1,0 | 44856-3 | 14,84 |
| Edelstahl matt/ stainless steel matt | 2,7 | 27 m | 8 x 19 x 1,0 | 44858-7 | 7,72 |
| Edelstahl matt/ stainless steel matt | | | 8 x 19 x 1,5 | 44860-0 | 14,30 |
| Messing poliert/ brass polished | | | 8 x 19 x 1,0 | 44862-4 | 14,84 |
| Edelstahl matt/ stainless steel matt | 2,7 | 27 m | 8 x 29 x 1,0 | 44864-8 | 8,70 |
| Edelstahl matt/ stainless steel matt | | | 8 x 29 x 1,5 | 44866-2 | 18,08 |
| Messing poliert/ brass polished | | | 8 x 29 x 1,0 | 44868-6 | 20,26 |
| Edelstahl matt/ stainless steel matt | 2,7 | 27 m | 10 x 17 x 1,0 | 44870-9 | 7,72 |
| Edelstahl matt/ stainless steel matt | | | 10 x 17 x 1,5 | 44872-3 | 14,30 |
| Messing poliert/ brass polished | | | 10 x 17 x 1,0 | 44874-7 | 14,84 |
| Edelstahl matt/ stainless steel matt | 2,7 | 27 m | 10 x 27 x 1,0 | 44876-1 | 9,08 |
| Edelstahl matt/ stainless steel matt | | | 10 x 27 x 1,5 | 44878-5 | 18,08 |
| Messing poliert/ brass polished | | | 10 x 27 x 1,0 | 44880-8 | 20,26 |
| Edelstahl poliert/ stainless steel polished | 2,7 | 27 m | 12 x 26 x 1,5 | 44882-2 | 9,48 |
| Edelstahl matt/ stainless steel matt | | | 15 x 22 x 1,0 | 44884-6 | 8,70 |
| Edelstahl matt/ stainless steel matt | | | 15 x 22 x 1,5 | 44886-0 | 18,08 |
| Messing poliert/ brass polished | | | 15 x 22 x 1,0 | 44888-4 | 20,26 |

Maßtoleranz ± 1mm, andere Abmessungen und Oberflächen auf Anfrage

tolerance ± 1 mm, other sizes and finishes available on request

3. WAND-, KANTENSCHUTZ- & SPEZIALPROFILE/ 3. WALL+CORNER PROTECTION+SPECIAL PROFILES

Andere Abmaße, ungebohrt oder Lochbild auf Anfrage

other dimensions, undrilled or custom drill hole on demand

| |
|---|
| Niveausgleichsprofile für individuelle Höhen, Edelstahl matt, VE 1 Stück |
| levelling profiles for individual heights, stainless steel matt, unit 1 pcs. |

397 Niveausgleich 15 x 20 x 1,5 / 2,0 / 3,0 mm, Edelstahl matt, gebohrt

level compensation profile 15 x 20 x 1,5 / 2,0 / 3,0 mm, stainless steel matt, drilled

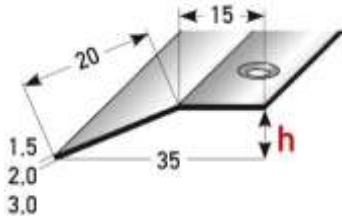

| L / l (m) | 1,5 mm | | 2,0 mm | | 3,0 mm | | |
|-----------|---------------------------|-----------|---------------------------|-----------|---------------------------|-----------|-------|
| | Materialstärke/ thickness | Art./ref. | Materialstärke/ thickness | Art./ref. | Materialstärke/ thickness | Art./ref. | |
| 1,00 | €/Stk./pcs. | 67370-5 | 20,12 | 67376-7 | 25,22 | 67382-8 | 33,68 |
| 1,25 | €/Stk./pcs. | 67372-9 | 25,14 | 67378-1 | 31,50 | 67384-2 | 42,06 |
| 2,50 | €/Stk./pcs. | 67374-3 | 50,24 | 67380-4 | 63,00 | 67386-6 | 84,18 |

3,0 mm Material für Gabelstapler + Hubwagen
 3,0 mm material for forklifts + pallet trucks

individuelle Höhe = h immer angeben!

individual height = h always specify!

Wir empfehlen bei dieser Profilbreite eine maximale Ausgleichshöhe von bis zu 8 mm.

We recommend a maximum height compensation of up to 8 mm for this profile width.

398 Niveausgleich 15 x 30 x 1,5 / 2,0 / 3,0 mm, Edelstahl matt, gebohrt

level compensation profile 15 x 30 x 1,5 / 2,0 / 3,0 mm, stainless steel matt, drilled

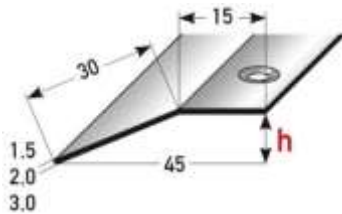

| L / l (m) | 1,5 mm | | 2,0 mm | | 3,0 mm | | |
|-----------|---------------------------|-----------|---------------------------|-----------|---------------------------|-----------|--------|
| | Materialstärke/ thickness | Art./ref. | Materialstärke/ thickness | Art./ref. | Materialstärke/ thickness | Art./ref. | |
| 1,00 | €/Stk./pcs. | 67394-1 | 24,46 | 67400-9 | 31,00 | 67406-1 | 42,40 |
| 1,25 | €/Stk./pcs. | 67396-5 | 30,60 | 67402-3 | 38,78 | 67408-5 | 53,00 |
| 2,50 | €/Stk./pcs. | 67398-9 | 61,16 | 67404-7 | 77,52 | 67410-8 | 105,96 |

3,0 mm Material für Gabelstapler + Hubwagen
 3,0 mm material for forklifts + pallet trucks

individuelle Höhe = h immer angeben!

individual height = h always specify!

Wir empfehlen bei dieser Profilbreite eine maximale Ausgleichshöhe von bis zu 15 mm.

We recommend a maximum height compensation of up to 15 mm for this profile width.

241 Niveausgleich 20 x 50 x 1,5 / 2,0 / 3,0 mm, Edelstahl matt, gebohrt

level compensation profile 20 x 50 x 1,5 / 2,0 / 3,0 mm, stainless steel matt, drilled

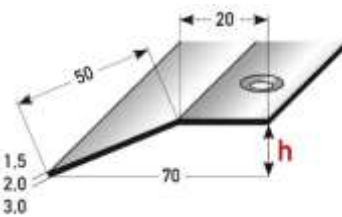

| L / l (m) | 1,5 mm | | 2,0 mm | | 3,0 mm | | |
|-----------|---------------------------|-----------|---------------------------|-----------|---------------------------|-----------|--------|
| | Materialstärke/ thickness | Art./ref. | Materialstärke/ thickness | Art./ref. | Materialstärke/ thickness | Art./ref. | |
| 1,00 | €/Stk./pcs. | 60145-6 | 37,86 | 60635-2 | 50,46 | 60760-1 | 75,72 |
| 1,25 | €/Stk./pcs. | 60150-0 | 47,36 | 60640-6 | 63,10 | 60765-6 | 94,64 |
| 2,50 | €/Stk./pcs. | 60160-9 | 94,62 | 60645-1 | 126,18 | 60770-0 | 189,26 |

3,0 mm Material für Gabelstapler + Hubwagen
 3,0 mm material for forklifts + pallet trucks

individuelle Höhe = h immer angeben!

individual height = h always specify!

Wir empfehlen bei dieser Profilbreite eine maximale Ausgleichshöhe von bis zu 30 mm.

We recommend a maximum height compensation of up to 30 mm for this profile width.

3. WAND-, KANTENSCHUTZ- & SPEZIALPROFILE/ 3. WALL+CORNER PROTECTION+SPECIAL PROFILES

Andere Abmaße auf Anfrage/

other dimensions on demand

passende Edelstahlschrauben siehe

Abschnitt 12/ suitable stainless steel screws see section 12

| Spezialprofile mit Schutzfolie, VE 1 Stück | | | | |
|---|-----------|------------|-----------|-----|
| custom profiles with protective film, unit 1 pcs. | | | | |
| Material/material | L / l (m) | AxBxC (mm) | Art./ref. | €/m |

230 Kabelabdeckung, robust, beidseitig selbstklebend

230 cable cover, robust, double-sided self-adhesive

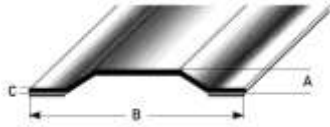

| | | | | |
|--|-------|----------------|---------|-------|
| Edelstahl matt stainless steel matt | 2,5 m | 10 x 80 x 1,5 | 45500-4 | 64,88 |
| | | 10 x 100 x 1,5 | 45505-9 | 75,72 |
| | | 15 x 120 x 1,5 | 45510-3 | 86,50 |
| ALU walzblank aluminum mill finish | 2,5 m | 10 x 80 x 2,0 | 45515-8 | 21,86 |
| | | 10 x 100 x 2,0 | 45520-2 | 25,54 |
| | | 15 x 120 x 3,0 | 45525-7 | 29,14 |

Achtung: VDE-Vorschriften sind zu beachten !! alternative Materialstärken 2,0 und 3,0 mm auf Anfrage

Please adhere to the law when installing electric cables! alternative material thicknesses 2,0 and 3,0 mm on request

231 Mattenrahmenprofil, Edelstahl matt, gebohrt

231 frame profile, stainless steel matt, drilled



Rahmenfertigung auf Anfrage/
frame manufacturing on request

| L / l (m) | AxBxC (mm) | Art./ref. | €/m |
|-----------|---------------|-----------|-------|
| 2,5 m | 10 x 30 x 1,5 | 45541-7 | 32,46 |
| | 15 x 30 x 1,5 | 45540-0 | 32,46 |
| | 20 x 40 x 1,5 | 45545-5 | 40,58 |
| | 25 x 50 x 1,5 | 45550-9 | 48,68 |
| | 20 x 40 x 2,0 | 45555-4 | 54,04 |
| | 25 x 50 x 2,0 | 45560-8 | 64,90 |

232 Natursteintrennprofil, Edelstahl matt, gebohrt

232 stone separation profile, stainless steel matt, drilled

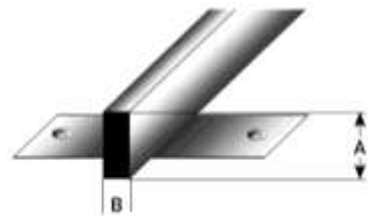

Profil auch ohne Befestigungslaschen auf Anfrage erhältlich/
profile also available without fastening strips on request

| L / l (m) | AxB (mm) | Art./ref. | €/m |
|---|----------|-----------|-------|
| Länge auf Anfrage/ length on request | 10 x 3 | 45575-2 | 40,28 |
| | 15 x 3 | 45580-6 | 46,44 |
| | 20 x 3 | 45585-1 | 53,10 |
| | 5 x 5 | 45590-5 | 38,06 |
| | 10 x 5 | 45595-0 | 48,66 |
| | 12 x 5 | 45600-1 | 53,10 |
| | 15 x 5 | 45605-6 | 59,82 |
| | 20 x 5 | 45610-0 | 70,94 |

andere Höhen auf Anfrage/ other heights on request

233 Läuferabschlussschiene schwer, Edelstahl matt, gebohrt

233 carpet end profile, heavy duty, stainless steel matt, drilled

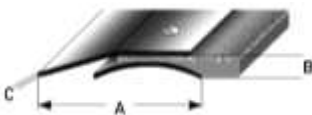

für freiliegende Montage ohne Untergrundbefestigung
for exposed installation without base attachment

| L / l (m) | AxBxC (mm) | Art./ref. | €/m |
|-----------|---------------|-----------|-------|
| 2,5 m | 50 x 5 x 1,5 | 45625-4 | 73,56 |
| | 60 x 10 x 1,5 | 45630-8 | 78,90 |
| | 70 x 15 x 1,5 | 45635-3 | 84,34 |

Bitte die Läuferdicke angeben!! Please specify carpet thickness.

Alternative Materialstärken 2,0 & 3,0 mm auf Anfrage
alternative material thickness 2,0 and 3,0 mm on request

234 Flieseneckschutz, Edelstahl matt 1,0 mm

234 ceramic tile corner protection, stainless steel matt 1,0 mm

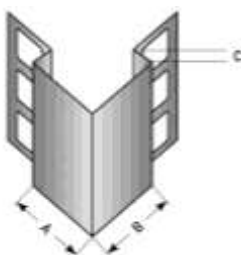

verdeckter Befestigungsschenkel
Hohlräume mit Mörtel hinterfüllen
hidden attachment flanges
fill any gaps with concrete

| L / l (m) | AxBxC (mm) | Art./ref. | €/m |
|-----------|----------------|-----------|-------|
| 2,5 m | 25 x 25 x 6 | 45650-6 | 55,34 |
| | 25 x 25 x 8 | 45655-1 | 57,56 |
| | 25 x 25 x 10 | 45660-5 | 60,56 |
| | 25 x 25 x 12,5 | 45665-0 | 64,08 |
| | 30 x 30 x 6 | 45670-4 | 58,52 |
| | 30 x 30 x 8 | 45675-9 | 60,78 |
| | 30 x 30 x 10 | 45680-3 | 63,78 |
| | 30 x 30 x 12,5 | 45685-8 | 67,28 |
| | 40 x 40 x 6 | 45690-2 | 64,98 |
| | 40 x 40 x 8 | 45695-7 | 67,20 |
| | 40 x 40 x 10 | 45700-8 | 70,20 |
| | 40 x 40 x 12,5 | 45705-3 | 73,68 |

3 Teile punktgeschweißt Einbau bündig mit Belag
3 parts spot welded installation flush with flooring

andere Abmessungen und Oberflächen auf Anfrage
other sizes and surface treatments on request

4. ÜBERGANGSPROFILE AUS ALUMINIUM, EDELSTAHL UND MESSING

4. CONNECTING PROFILES OUT OF ALUMINIUM + STAINLESS STEEL + BRASS

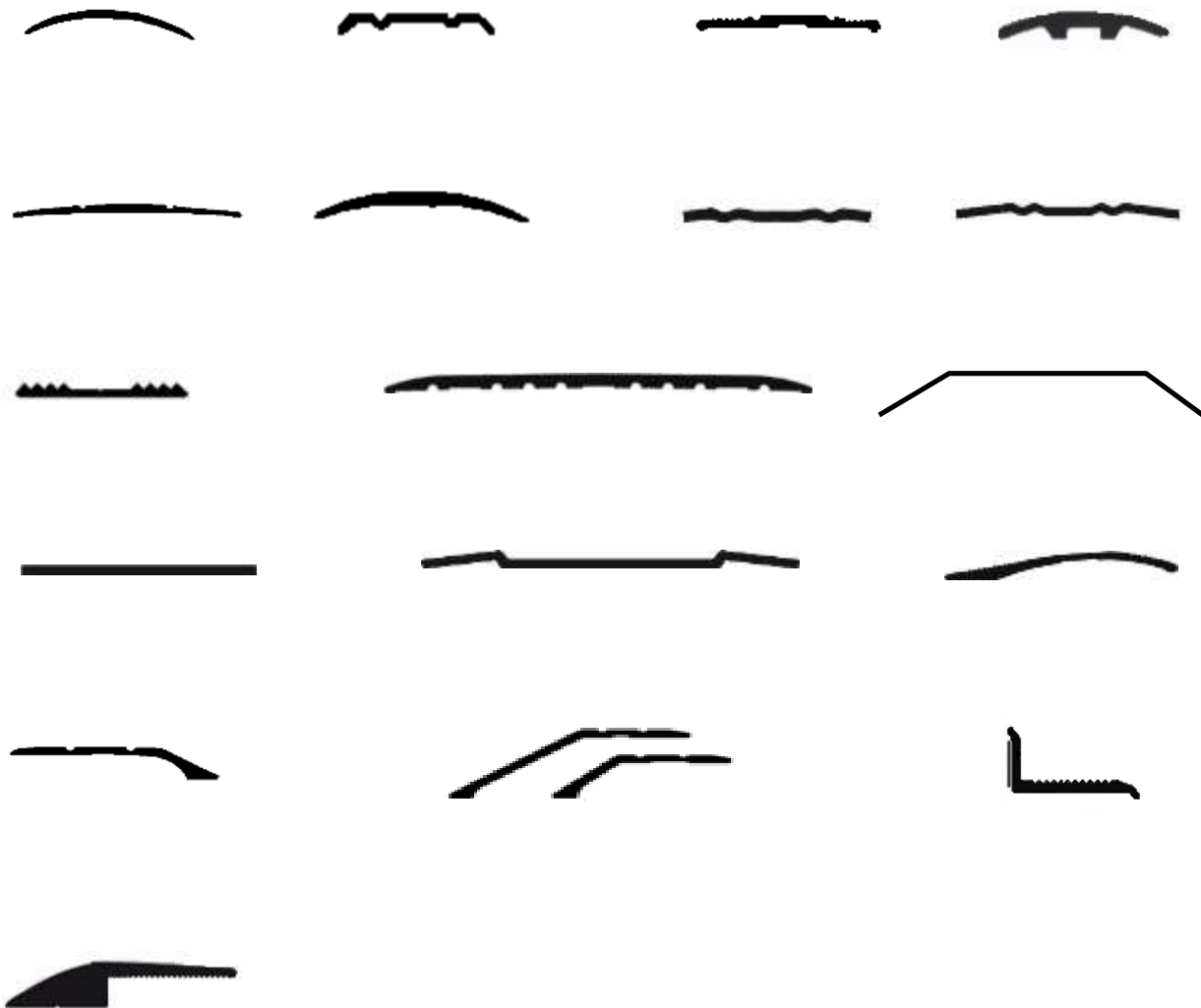

4. ÜBERGANGSPROFILE/ 4. CONNECTING PROFILES

Seitlich gebohrt, ungebohrt oder als Flachstreifen auf Anfrage erhältlich!

Laterally drilled, undrilled or as flat profile available on demand!

| Profi-Pack à 10 Stück im Bund | | | |
|---|-----------|-----------|-------------|
| professional packing à 10 pcs. | | | |
| Dicke + Befestigung thickness + fixing | L / l (m) | Art./ref. | €/Stk./pcs. |

| SB-Pack incl. Schr / Dübel; VE 20 Stk. | |
|---|-------------|
| self-service-pack with screws / dowels; à 20 pcs. | |
| Art./ref. | €/Stk./pcs. |

142 Übergangsprofil 20 mm, Messing poliert, mit Schutzfolie

connecting profile 20 mm, brass polished, with protective film

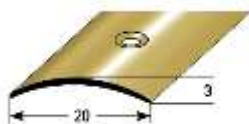

| 1,2 mm | mittig gebohrt centrally drilled | 0,9 | 41200-7 | 7,74 |
|--------|-------------------------------------|-----|---------|-------|
| | | 1,0 | 41210-6 | 8,60 |
| | | 2,7 | 41220-5 | 23,20 |

| | |
|---------|-------|
| 41201-4 | 8,92 |
| 41211-3 | 9,92 |
| 41221-2 | 26,74 |

143 Übergangsprofil 20 mm, Edelstahl poliert, mit Schutzfolie

connecting profile 20 mm, stainless steel polished, with protective film

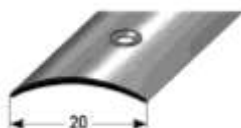

| 1,0 mm | mittig gebohrt centrally drilled | 0,9 | 41230-4 | 5,86 |
|--------|-------------------------------------|-----|---------|-------|
| | | 1,0 | 41240-3 | 6,48 |
| | | 2,7 | 41250-2 | 17,54 |
| 1,5 mm | mittig gebohrt centrally drilled | 1,0 | 42220-4 | 7,20 |
| | | 2,7 | 42230-3 | 19,28 |
| 2,0 mm | mittig gebohrt centrally drilled | 1,0 | 42250-1 | 8,30 |
| | | 2,7 | 42260-0 | 22,46 |

| | |
|---------|-------|
| 41231-1 | 6,78 |
| 41241-0 | 7,54 |
| 41251-9 | 20,30 |
| 42221-1 | 8,18 |
| 42231-0 | 22,14 |
| 42251-8 | 9,42 |
| 42261-7 | 25,32 |

144 Übergangsprofil 20 mm, Edelstahl matt, mit Schutzfolie

connecting profile 20 mm, stainless steel matt, with protective film



| 1,0 mm | mittig gebohrt centrally drilled | 1,0 | 42280-8 | 7,76 |
|--------|-------------------------------------|-----|---------|-------|
| | | 2,7 | 42290-7 | 21,06 |
| 1,5 mm | mittig gebohrt centrally drilled | 1,0 | 42310-2 | 9,88 |
| | | 2,7 | 42320-1 | 26,68 |
| 2,0 mm | mittig gebohrt centrally drilled | 1,0 | 42340-9 | 12,08 |
| | | 2,7 | 42350-8 | 32,54 |

| | |
|---------|-------|
| 42281-5 | 8,84 |
| 42291-4 | 23,84 |
| 42311-9 | 11,00 |
| 42321-8 | 29,64 |
| 42341-6 | 13,16 |
| 42351-5 | 35,44 |

524 Stegübergangsprofil 20 x 3,0 mm, Aluminium eloxiert, mittig gebohrt

connecting profile with bars 20 x 3,0 mm, aluminium anodized, centrally drilled

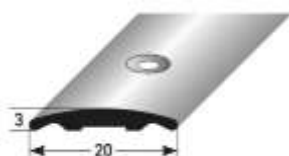

| Farbe/colour | L / l (m) | Art./ref. | €/Stk./pcs. |
|--|-----------|-----------|-------------|
| silberfarbig silver | 0,9 | 72058-4 | 5,50 |
| | 2,7 | 72060-7 | 14,84 |
| edelstahlfarbig Feinschliff fine-honed stainless steel coloured | 0,9 | 72066-9 | 7,46 |
| | 2,7 | 72068-3 | 20,16 |

| Art./ref. | €/Stk./pcs. |
|-----------|-------------|
| 72062-1 | 6,44 |
| 72064-5 | 17,66 |
| 72070-6 | 8,42 |
| 72072-0 | 23,00 |

Andere Eloxalfarben siehe Abschnitt 6, Lieferzeit 14 Tage
other anodized colours see section 6, delivery time 14 days

4. ÜBERGANGSPROFILE/ 4. CONNECTING PROFILES

Seitlich gebohrt, ungebohrt oder als Flachstreifen auf Anfrage erhältlich!

Laterally drilled, undrilled or as flat profile available on demand!

| Profi-Pack à 10 Stück im Bund | | | |
|---|-----------|-----------|-------------|
| professional packing à 10 pcs. | | | |
| Dicke + Befestigung thickness + fixing | L / l (m) | Art./ref. | €/Stk./pcs. |

| SB-Pack incl. Schr./ Dübel; VE 20 Stk. | |
|---|-------------|
| self-service-pack with screws/ dowels; à 20 pcs. | |
| Art./ref. | €/Stk./pcs. |

01 Übergangsprofil 28 mm, Messing poliert, mit Schutzfolie

connecting profile 28 mm,
brass polished, with
protective film

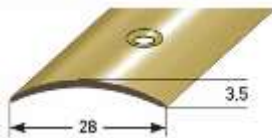

Bitte fordern Sie unsere
Pfleheinweise für
Messingprofile an!

Please ask for our care tips
for brass profiles!

Längen bis 5,0 m
auf Anfrage/ lengths up
to 5,0 m on request

| 1,0 mm | mittig gebohrt centrally drilled | 0,9 | 03090-4 | 12,16 |
|--------|---------------------------------------|-----|---------|-------|
| | | 1,0 | 03100-0 | 13,52 |
| | | 2,0 | 03110-9 | 27,00 |
| | | 2,7 | 03120-8 | 36,42 |
| | seitlich gebohrt laterally drilled | 0,9 | 03390-5 | 12,16 |
| | | 1,0 | 03400-1 | 13,52 |
| | | 2,0 | 03410-0 | 27,00 |
| | | 2,7 | 03420-9 | 36,42 |
| | selbstklebend self-adhesive | 0,9 | 03093-5 | 13,82 |
| | | 1,0 | 03103-1 | 15,16 |
| | | 2,7 | 03123-9 | 40,92 |

| | |
|---------|-------|
| 03091-1 | 13,26 |
| 03101-7 | 14,60 |
| 03111-6 | 29,18 |
| 03121-5 | 39,74 |
| 03391-2 | 13,26 |
| 03401-8 | 14,60 |
| 03411-7 | 29,18 |
| 03421-6 | 39,74 |
| 03092-8 | 14,62 |
| 03102-4 | 15,98 |
| 03126-0 | 43,36 |

| 1,2 mm | mittig gebohrt centrally drilled | 0,9 | 03095-9 | 14,00 |
|--------|---------------------------------------|-----|---------|-------|
| | | 1,0 | 03105-5 | 15,52 |
| | | 2,7 | 03125-3 | 41,90 |
| | seitlich gebohrt laterally drilled | 0,9 | 03094-2 | 14,00 |
| | | 1,0 | 02104-9 | 15,52 |
| | | 2,7 | 03124-6 | 41,90 |
| | selbstklebend self-adhesive | 0,9 | 03097-3 | 15,60 |
| | | 1,0 | 03107-9 | 17,16 |
| | | 2,7 | 03127-7 | 46,34 |

| | |
|---------|-------|
| 03096-6 | 15,08 |
| 03106-2 | 16,58 |
| 03122-2 | 45,20 |
| 03099-7 | 15,08 |
| 03109-3 | 16,58 |
| 03129-1 | 45,20 |
| 03098-0 | 16,44 |
| 03108-6 | 17,98 |
| 03128-4 | 48,84 |

4. ÜBERGANGSPROFILE/ 4. CONNECTING PROFILES

Seitlich gebohrt, ungebohrt oder als Flachstreifen auf Anfrage erhältlich!

Laterally drilled, undrilled or as flat profile available on demand!

| Profi-Pack à 10 Stück im Bund | | | |
|---|-----------|-----------|-------------|
| professional packing à 10 pcs. | | | |
| Dicke + Befestigung thickness + fixing | L / l (m) | Art./ref. | €/Stk./pcs. |

| SB-Pack incl. Schr./ Dübel; VE 20 Stk. | |
|---|-------------|
| self-service-pack with screws/ dowels; à 20 pcs. | |
| Art./ref. | €/Stk./pcs. |

13 Übergangprofil 28 mm, Edelstahl poliert, mit Schutzfolie

connecting profile 28 mm, stainless steel polished, with protective film

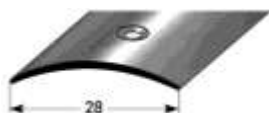

| 1,0 mm | mittig gebohrt centrally drilled | 0,9 | 03190-1 | 4,72 |
|--------|---------------------------------------|-----|---------|-------|
| | | 1,0 | 03200-7 | 5,22 |
| | | 2,0 | 03210-6 | 10,50 |
| | | 2,7 | 03220-5 | 14,14 |
| | seitlich gebohrt laterally drilled | 0,9 | 03490-2 | 4,72 |
| | | 1,0 | 03500-8 | 5,22 |
| | | 2,0 | 03510-7 | 10,50 |
| | | 2,7 | 03520-6 | 14,14 |
| | selbstklebend self-adhesive | 0,9 | 03193-2 | 6,14 |
| | | 1,0 | 03203-8 | 6,84 |
| | | 2,7 | 03223-6 | 18,42 |

| | |
|---------|-------|
| 03191-8 | 5,66 |
| 03201-4 | 6,16 |
| 03211-3 | 12,32 |
| 03221-2 | 17,00 |
| 03491-9 | 5,66 |
| 03501-5 | 6,16 |
| 03511-4 | 12,32 |
| 03521-3 | 17,00 |
| 03192-5 | 6,86 |
| 03202-1 | 7,54 |
| 03224-3 | 20,58 |

| 1,5 mm | mittig gebohrt centrally drilled | 1,0 | 42370-6 | 7,10 |
|--------|-------------------------------------|-----|---------|-------|
| | | 2,7 | 42380-5 | 19,20 |
| | selbstklebend self-adhesive | 1,0 | 42400-0 | 8,54 |
| | | 2,7 | 42410-9 | 23,04 |

| | |
|---------|-------|
| 42371-3 | 8,06 |
| 42381-2 | 22,08 |
| 42401-7 | 9,26 |
| 42411-6 | 25,22 |

| 2,0 mm | mittig gebohrt centrally drilled | 1,0 | 42430-7 | 8,52 |
|--------|-------------------------------------|-----|---------|-------|
| | | 2,7 | 42440-6 | 22,98 |
| | selbstklebend self-adhesive | 1,0 | 42460-4 | 9,94 |
| | | 2,7 | 42470-3 | 26,86 |

| | |
|---------|-------|
| 42431-4 | 9,46 |
| 42441-3 | 25,84 |
| 42461-1 | 10,64 |
| 42471-0 | 29,00 |

14 Übergangprofil 28 mm, Edelstahl matt, mit Schutzfolie

connecting profile 28 mm, stainless steel matt, with protective film

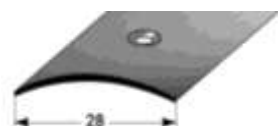

| 1,0 mm | mittig gebohrt centrally drilled | 0,9 | 03690-6 | 6,16 |
|--------|---------------------------------------|-----|---------|-------|
| | | 1,0 | 03700-2 | 6,86 |
| | | 2,7 | 03720-0 | 18,50 |
| | seitlich gebohrt laterally drilled | 0,9 | 03790-3 | 6,16 |
| | | 1,0 | 03800-9 | 6,86 |
| | | 2,7 | 03820-7 | 18,50 |
| | selbstklebend self-adhesive | 0,9 | 03890-0 | 7,60 |
| | | 1,0 | 03900-6 | 8,28 |
| | | 2,7 | 03920-4 | 22,34 |

| | |
|---------|-------|
| 03691-3 | 7,10 |
| 03701-9 | 7,78 |
| 03721-7 | 21,34 |
| 03791-0 | 7,10 |
| 03801-6 | 7,78 |
| 03821-4 | 21,34 |
| 03891-7 | 8,30 |
| 03901-3 | 8,68 |
| 03921-1 | 24,52 |

| 1,5 mm | mittig gebohrt centrally drilled | 1,0 | 60005-3 | 9,66 |
|--------|-------------------------------------|-----|---------|-------|
| | | 2,7 | 60021-3 | 26,08 |
| | selbstklebend self-adhesive | 1,0 | 60007-7 | 11,10 |
| | | 2,7 | 60009-1 | 29,90 |

| | |
|---------|-------|
| 60006-0 | 10,60 |
| 60023-7 | 28,94 |
| 60024-4 | 11,76 |
| 60026-8 | 32,12 |

| 2,0 mm | mittig gebohrt centrally drilled | 1,0 | 60530-0 | 12,80 |
|--------|-------------------------------------|-----|---------|-------|
| | | 2,7 | 60542-3 | 34,62 |
| | selbstklebend self-adhesive | 1,0 | 60532-4 | 14,54 |
| | | 2,7 | 60538-6 | 39,26 |

| | |
|---------|-------|
| 60531-7 | 13,76 |
| 60543-0 | 37,50 |
| 60533-1 | 15,26 |
| 60539-3 | 41,38 |

4. ÜBERGANGSPROFILE/ 4. CONNECTING PROFILES

Andere Eloxalfarben siehe
 Abschnitt 6, Lieferzeit 14 Tage/
 other anodized colours see section 6,
 delivery time 14 days

| Profi-Pack à 10 Stück im Bund | | | |
|--------------------------------|-----------|-----------|-------------|
| professional packing à 10 pcs. | | | |
| Farbe/colour | L / l (m) | Art./ref. | €/Stk./pcs. |

| SB-Pack incl. Schr./ Dübel; VE 20 Stk. | |
|---|-------------|
| self-service-pack with screws/ dowels; à 20 pcs. | |
| Art./ref. | €/Stk./pcs. |

05 Übergangprofil 28 x 1,5 mm, Aluminium eloxiert, mittig gebohrt

connecting profile 28 x 1,5 mm,
 aluminium anodized,
 centrally drilled

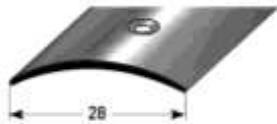

seitlich gebohrt auf Anfrage
 laterally drilled on request

| | | | |
|--|-----|---------|-------|
| silberfarbig silver | 0,9 | 08490-7 | 4,28 |
| | 1,0 | 08500-3 | 4,74 |
| | 2,0 | 08510-2 | 9,48 |
| | 2,7 | 08520-1 | 12,82 |
| goldfarbig gold | 0,9 | 08590-4 | 5,54 |
| | 1,0 | 08600-0 | 6,16 |
| | 2,0 | 08610-9 | 12,40 |
| | 2,7 | 08620-8 | 16,76 |
| bronzefarbig hell bronze light | 0,9 | 08690-1 | 5,88 |
| | 1,0 | 08700-7 | 6,54 |
| | 2,0 | 08710-6 | 13,10 |
| | 2,7 | 08720-5 | 17,66 |
| bronzefarbig dunkel bronze dark | 0,9 | 08790-8 | 5,88 |
| | 1,0 | 08800-4 | 6,54 |
| | 2,0 | 08810-3 | 13,10 |
| | 2,7 | 08820-2 | 17,66 |
| gold hell gold light | 0,9 | 70802-5 | 5,54 |
| | 1,0 | 70804-9 | 6,16 |
| | 2,0 | 70806-3 | 12,40 |
| | 2,7 | 70808-7 | 16,76 |
| edelstahlfarbig Feinschliff fine-honed stainless steel coloured | 0,9 | 70818-6 | 5,88 |
| | 1,0 | 70820-9 | 6,54 |
| | 2,0 | 70822-3 | 13,10 |
| | 2,7 | 70824-7 | 17,66 |
| schwarz black | 1,0 | 72076-8 | 6,54 |
| | 2,7 | 72078-2 | 17,66 |

| | |
|---------|-------|
| 08491-4 | 5,14 |
| 08501-0 | 5,62 |
| 08511-9 | 11,24 |
| 08521-8 | 15,30 |
| 08591-1 | 6,44 |
| 08601-7 | 7,20 |
| 08611-6 | 14,28 |
| 08621-5 | 19,28 |
| 08691-8 | 7,20 |
| 08701-4 | 7,98 |
| 08711-3 | 15,88 |
| 08721-2 | 21,50 |
| 08791-5 | 6,76 |
| 08801-1 | 7,48 |
| 08811-0 | 14,98 |
| 08821-9 | 20,18 |
| 70810-0 | 6,44 |
| 70812-4 | 7,20 |
| 70814-8 | 14,28 |
| 70816-2 | 19,28 |
| 70826-1 | 6,76 |
| 70828-5 | 7,48 |
| 70830-8 | 14,98 |
| 70832-2 | 20,18 |
| 72080-5 | 7,48 |
| 72082-9 | 20,18 |



Holzdekorfolie/ wood decor

| | | | |
|------------------------------|-----|---------|-------|
| Buche beech | 1,0 | 38160-0 | 11,16 |
| | 2,7 | 38170-9 | 30,14 |
| Eiche oak | 1,0 | 38180-8 | 11,16 |
| | 2,7 | 38190-7 | 30,14 |
| Ahorn maple | 1,0 | 38200-3 | 11,16 |
| | 2,7 | 38210-2 | 30,14 |
| Kirschbaum cherry wood | 1,0 | 38220-1 | 11,16 |
| | 2,7 | 38225-6 | 30,14 |
| Eiche rustikal rustic oak | 1,0 | 38230-0 | 11,16 |
| | 2,7 | 38235-5 | 30,14 |

| | |
|---------|-------|
| 38161-7 | 12,14 |
| 38171-6 | 32,78 |
| 38181-5 | 12,14 |
| 38191-4 | 32,78 |
| 38201-0 | 12,14 |
| 38211-9 | 32,78 |
| 38221-8 | 12,14 |
| 38226-3 | 32,78 |
| 38231-7 | 12,14 |
| 38236-2 | 32,78 |

4. ÜBERGANGSPROFILE/ 4. CONNECTING PROFILES

Andere Eloxalfarben siehe
 Abschnitt 6, Lieferzeit 14 Tage/
 other anodized colours see section 6,
 delivery time 14 days

| Profi-Pack à 10 Stück im Bund | | | |
|--------------------------------|-----------|-----------|-------------|
| professional packing à 10 pcs. | | | |
| Farbe/colour | L / l (m) | Art./ref. | €/Stk./pcs. |

| SB-Pack; VE 20 Stk. | |
|------------------------------|-------------|
| self-service-pack; à 20 pcs. | |
| Art./ref. | €/Stk./pcs. |

05 Übergangsprofil 28 x 1,5 mm, Aluminium eloxiert, selbstklebend

connecting profile 28 x 1,5 mm,
 aluminium anodized,
 self-adhesive

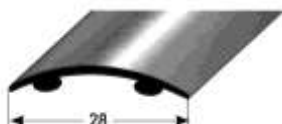

| | | | |
|--|-----|---------|-------|
| silberfarbig silver | 0,9 | 08493-8 | 6,10 |
| | 1,0 | 08503-4 | 6,80 |
| | 2,7 | 08523-2 | 18,36 |
| goldfarbig gold | 0,9 | 08593-5 | 7,54 |
| | 1,0 | 08603-1 | 8,42 |
| | 2,7 | 08623-9 | 22,62 |
| bronzefarbig hell bronze light | 0,9 | 08693-2 | 7,86 |
| | 1,0 | 08703-8 | 8,68 |
| | 2,7 | 08723-6 | 23,54 |
| bronzefarbig dunkel bronze dark | 0,9 | 08793-9 | 7,86 |
| | 1,0 | 08803-5 | 8,68 |
| | 2,7 | 08823-3 | 23,54 |
| gold hell gold light | 0,9 | 70836-0 | 7,54 |
| | 1,0 | 70838-4 | 8,42 |
| | 2,7 | 70840-7 | 22,62 |
| edelstahlfarbig Feinschliff fine-honed stainless steel coloured | 0,9 | 70848-3 | 7,86 |
| | 1,0 | 70850-6 | 8,68 |
| | 2,7 | 70852-0 | 23,54 |
| schwarz black | 1,0 | 72084-3 | 8,68 |
| | 2,7 | 72086-7 | 23,54 |

| | |
|---------|-------|
| 08492-1 | 6,72 |
| 08502-7 | 7,38 |
| 08524-9 | 20,08 |
| 08592-8 | 8,08 |
| 08602-4 | 9,00 |
| 08624-6 | 24,34 |
| 08692-5 | 8,44 |
| 08702-1 | 9,40 |
| 08724-3 | 25,24 |
| 08792-2 | 8,44 |
| 08802-8 | 9,40 |
| 08824-0 | 25,24 |
| 70842-1 | 8,08 |
| 70844-5 | 9,00 |
| 70846-9 | 24,34 |
| 70854-4 | 8,44 |
| 70856-8 | 9,40 |
| 70858-2 | 25,24 |
| 72088-1 | 9,40 |
| 72090-4 | 25,24 |

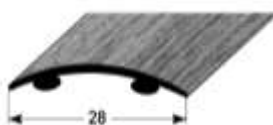

| Holzdekorfolie/ wood decor | | | |
|------------------------------|----------------|---------|---------|
| | Buche beech | 1,0 | 38100-6 |
| | 2,7 | 38110-5 | 37,08 |
| Eiche oak | 1,0 | 38120-4 | 13,76 |
| | 2,7 | 38130-3 | 37,08 |
| Ahorn maple | 1,0 | 38140-2 | 13,76 |
| | 2,7 | 38150-1 | 37,08 |
| Kirschbaum cherry wood | 1,0 | 38240-9 | 13,76 |
| | 2,7 | 38245-4 | 37,08 |
| Eiche rustikal rustic oak | 1,0 | 38250-8 | 13,76 |
| | 2,7 | 38255-3 | 37,08 |

| | |
|---------|-------|
| 38101-3 | 14,30 |
| 38111-2 | 38,72 |
| 38121-1 | 14,30 |
| 38131-0 | 38,72 |
| 38141-9 | 14,30 |
| 38151-8 | 38,72 |
| 38241-6 | 14,30 |
| 38246-1 | 38,72 |
| 38251-5 | 14,30 |
| 38256-0 | 38,72 |

Beispiel: oberes Übergangsprofil
 28 mm, Nr. 05, siehe Seite 53 + 54/
 unteres Übergangsprofil 38 mm,
 Nr. 12, siehe Seite 59 + 60
 upper connecting profile 28 mm,
 no. 05, see 53 + 54/
 lower connecting profile 38 mm,
 no. 12, see page 59 + 60



4. ÜBERGANGSPROFILE/ 4. CONNECTING PROFILES

Andere Eloxalfarben siehe

Abschnitt 6, Lieferzeit 14 Tage/

other anodized colours see section 6,
delivery time 14 days

10 Übergangprofil 24,5 x 1,25 mm, Aluminium eloxiert, mittig gebohrt

connecting profile 24,5 x 1,25 mm,
aluminium anodized,
centrally drilled



| Profi-Pack à 10 Stück im Bund | | | |
|---------------------------------------|-----------|-----------|-------------|
| professional packing à 10 pcs. | | | |
| Farbe/colour | L / l (m) | Art./ref. | €/Stk./pcs. |
| silberfarbig silver | 0,9 | 31105-8 | 5,32 |
| | 1,0 | 31110-2 | 5,90 |
| | 2,7 | 31115-7 | 15,92 |
| goldfarbig gold | 0,9 | 31120-1 | 5,44 |
| | 1,0 | 31125-6 | 6,02 |
| | 2,7 | 31130-0 | 16,30 |
| bronzefarbig hell bronze light | 0,9 | 31135-5 | 6,04 |
| | 1,0 | 31140-9 | 6,76 |
| | 2,7 | 31145-4 | 18,16 |
| bronzefarbig dunkel bronze dark | 0,9 | 31150-8 | 6,04 |
| | 1,0 | 31155-3 | 6,76 |
| | 2,7 | 31160-7 | 18,16 |

| SB-Pack incl. Schr./ Dübel; VE 20 Stk. | |
|---|-------------|
| self-service-pack with screws/ dowels; à 20 pcs. | |
| Art./ref. | €/Stk./pcs. |
| 31106-5 | 6,14 |
| 31111-9 | 6,86 |
| 31116-4 | 18,48 |
| 31121-8 | 6,28 |
| 31126-3 | 6,96 |
| 31131-7 | 18,86 |
| 31136-2 | 7,34 |
| 31141-6 | 8,14 |
| 31146-1 | 22,02 |
| 31151-5 | 6,92 |
| 31156-0 | 7,70 |
| 31161-4 | 20,74 |

10 Übergangprofil 24,5 x 1,25 mm, Aluminium eloxiert, selbstklebend

connecting profile 24,5 x 1,25 mm,
aluminium anodized,
self-adhesive



| | | | |
|---------------------------------------|-----|---------|-------|
| silberfarbig silver | 0,9 | 31107-2 | 7,28 |
| | 1,0 | 31112-6 | 8,06 |
| | 2,7 | 31118-8 | 21,74 |
| goldfarbig gold | 0,9 | 31122-5 | 7,38 |
| | 1,0 | 31127-0 | 8,18 |
| | 2,7 | 31133-1 | 22,14 |
| bronzefarbig hell bronze light | 0,9 | 31137-9 | 8,00 |
| | 1,0 | 31142-3 | 8,90 |
| | 2,7 | 31148-5 | 23,98 |
| bronzefarbig dunkel bronze dark | 0,9 | 31152-2 | 8,00 |
| | 1,0 | 31157-7 | 8,90 |
| | 2,7 | 31163-8 | 23,98 |

| | |
|---------|-------|
| 31108-9 | 7,86 |
| 31113-3 | 8,68 |
| 31117-1 | 23,54 |
| 31123-2 | 7,98 |
| 31128-7 | 8,84 |
| 31132-4 | 23,84 |
| 31138-6 | 8,60 |
| 31143-0 | 9,54 |
| 31147-8 | 25,74 |
| 31153-9 | 8,60 |
| 31158-4 | 9,54 |
| 31162-1 | 25,74 |

11 Übergangprofil 27 x 1,7 mm, Aluminium eloxiert, mittig gebohrt

connecting profile 27 x 1,7 mm,
aluminium anodized,
centrally drilled



| | | | |
|---------------------------------------|-----|---------|-------|
| silberfarbig silver | 0,9 | 23090-8 | 4,16 |
| | 1,0 | 23100-4 | 4,64 |
| | 2,0 | 23120-2 | 9,26 |
| | 2,7 | 23110-3 | 12,48 |
| goldfarbig gold | 0,9 | 23190-5 | 5,66 |
| | 1,0 | 23200-1 | 6,26 |
| | 2,0 | 23220-9 | 12,56 |
| | 2,7 | 23210-0 | 16,98 |
| bronzefarbig hell bronze light | 0,9 | 23290-2 | 6,24 |
| | 1,0 | 23300-8 | 6,94 |
| | 2,0 | 23320-6 | 13,94 |
| | 2,7 | 23310-7 | 18,74 |
| bronzefarbig dunkel bronze dark | 0,9 | 23390-9 | 6,24 |
| | 1,0 | 23400-5 | 6,94 |
| | 2,0 | 23420-3 | 13,94 |
| | 2,7 | 23410-4 | 18,74 |

| | |
|---------|-------|
| 23091-5 | 5,06 |
| 23101-1 | 5,52 |
| 23111-0 | 14,92 |
| 23191-2 | 6,52 |
| 23201-8 | 7,24 |
| 23211-7 | 19,52 |
| 23291-9 | 7,54 |
| 23301-5 | 8,42 |
| 23311-4 | 22,60 |
| 23391-6 | 7,10 |
| 23401-2 | 7,90 |
| 23411-1 | 21,30 |

11 Übergangprofil 27 x 1,7 mm, Aluminium eloxiert, selbstklebend

connecting profile 27 x 1,7 mm,
aluminium anodized,
self-adhesive



| | | | |
|---------------------------------------|-----|---------|-------|
| silberfarbig silver | 0,9 | 23093-9 | 5,92 |
| | 1,0 | 23103-5 | 6,54 |
| | 2,7 | 23123-3 | 17,62 |
| goldfarbig gold | 0,9 | 23193-6 | 7,40 |
| | 1,0 | 23203-2 | 8,24 |
| | 2,7 | 23223-0 | 22,26 |
| bronzefarbig hell bronze light | 0,9 | 23293-3 | 8,04 |
| | 1,0 | 23303-9 | 8,92 |
| | 2,7 | 23323-7 | 24,04 |
| bronzefarbig dunkel bronze dark | 0,9 | 23393-0 | 8,04 |
| | 1,0 | 23403-6 | 8,92 |
| | 2,7 | 23423-4 | 24,04 |

| | |
|---------|-------|
| 23092-2 | 6,52 |
| 23102-8 | 7,14 |
| 23122-6 | 19,40 |
| 23192-9 | 8,00 |
| 23202-5 | 8,90 |
| 23222-3 | 23,98 |
| 23292-6 | 8,62 |
| 23302-2 | 9,56 |
| 23322-0 | 25,80 |
| 23392-3 | 8,62 |
| 23402-9 | 9,56 |
| 23422-7 | 25,80 |

4. ÜBERGANGSPROFILE/ 4. CONNECTING PROFILES

Andere Eloxalfarben siehe
 Abschnitt 6, Lieferzeit 14 Tage/
 other anodized colours see section
 6, delivery time 14 days

| Profi-Pack à 10 Stück im Bund | | | |
|--------------------------------|-----------|-----------|-------------|
| professional packing à 10 pcs. | | | |
| Farbe/colour | L / l (m) | Art./ref. | €/Stk./pcs. |

| SB-Pack incl. Schr./ Dübel; VE 20 Stk. | |
|---|-------------|
| self-service-pack with screws/ dowels; à 20 pcs. | |
| Art./ref. | €/Stk./pcs. |

06 Stegübergangsprofil 28 x 4,5 mm, Aluminium eloxiert, mittig gebohrt

connecting profile with bars
 28 x 4,5 mm, aluminium
 anodized,
 centrally drilled

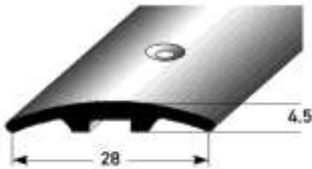

| | | | |
|------------------------------------|-----|---------|-------|
| silberfarbig silver | 0,9 | 31205-5 | 7,30 |
| | 1,0 | 31210-9 | 8,08 |
| | 2,7 | 31215-4 | 21,82 |
| goldfarbig gold | 0,9 | 31220-8 | 7,38 |
| | 1,0 | 31225-3 | 8,16 |
| | 2,7 | 31230-7 | 22,12 |
| bronzefarbig hell bronze light | 0,9 | 31235-2 | 7,62 |
| | 1,0 | 31240-6 | 8,48 |
| | 2,7 | 31245-1 | 22,84 |
| bronzefarbig dunkel bronze dark | 0,9 | 31250-5 | 7,62 |
| | 1,0 | 31255-0 | 8,48 |
| | 2,7 | 31260-4 | 22,84 |

| | |
|---------|-------|
| 31207-9 | 8,14 |
| 31212-3 | 9,02 |
| 31217-8 | 24,46 |
| 31222-2 | 8,24 |
| 31227-7 | 9,10 |
| 31232-1 | 24,70 |
| 31237-6 | 8,90 |
| 31242-0 | 9,86 |
| 31247-5 | 26,64 |
| 31252-9 | 8,50 |
| 31257-4 | 9,44 |
| 31262-8 | 25,42 |

06 Stegübergangsprofil 28 x 4,5 mm, Aluminium eloxiert, selbstklebend

connecting profile with bars
 28 x 4,5 mm, aluminium
 anodized,
 self-adhesive

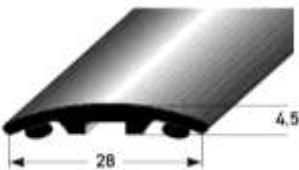

| | | | |
|------------------------------------|-----|---------|-------|
| silberfarbig silver | 0,9 | 31206-2 | 9,24 |
| | 1,0 | 31211-6 | 10,26 |
| | 2,7 | 31216-1 | 27,72 |
| goldfarbig gold | 0,9 | 31221-5 | 9,40 |
| | 1,0 | 31226-0 | 10,38 |
| | 2,7 | 31231-4 | 28,00 |
| bronzefarbig hell bronze light | 0,9 | 31236-9 | 9,56 |
| | 1,0 | 31241-3 | 10,62 |
| | 2,7 | 31246-8 | 28,70 |
| bronzefarbig dunkel bronze dark | 0,9 | 31251-2 | 9,56 |
| | 1,0 | 31256-7 | 10,62 |
| | 2,7 | 31261-1 | 28,70 |

| | |
|---------|-------|
| 31208-6 | 9,78 |
| 31213-0 | 10,94 |
| 31218-5 | 29,48 |
| 31223-9 | 9,88 |
| 31228-4 | 11,06 |
| 31233-8 | 29,70 |
| 31238-3 | 10,18 |
| 31243-7 | 11,26 |
| 31248-2 | 30,42 |
| 31253-6 | 10,18 |
| 31258-1 | 11,26 |
| 31263-5 | 30,42 |

4. ÜBERGANGSPROFILE/ 4. CONNECTING PROFILES

Andere Eloxalfarben siehe
 Abschnitt 6, Lieferzeit 14 Tage/
 other anodized colours see section 6,
 delivery time 14 days

| Profi-Pack à 10 Stück im Bund | | | |
|--------------------------------|-----------|-----------|-------------|
| professional packing à 10 pcs. | | | |
| Farbe/colour | L / l (m) | Art./ref. | €/Stk./pcs. |

| SB-Pack incl. Schr./ Dübel; VE 20 Stk. | |
|---|-------------|
| self-service-pack with screws/ dowels; à 20 pcs. | |
| Art./ref. | €/Stk./pcs. |

07 Übergangprofil 37 x 4,5 mm, Aluminium eloxiert, mittig gebohrt

connecting profile 37 x 4,5 mm,
 aluminium anodized,
 centrally drilled



| | | | |
|---------------------------------------|-----|---------|-------|
| silberfarbig silver | 0,9 | 31305-2 | 9,40 |
| | 1,0 | 31310-6 | 10,40 |
| | 2,7 | 31315-1 | 28,10 |
| goldfarbig gold | 0,9 | 31320-5 | 9,60 |
| | 1,0 | 31325-0 | 10,64 |
| | 2,7 | 31330-4 | 28,80 |
| bronzefarbig hell bronze light | 0,9 | 31335-9 | 10,44 |
| | 1,0 | 31340-3 | 11,58 |
| | 2,7 | 31345-8 | 31,32 |
| bronzefarbig dunkel bronze dark | 0,9 | 31350-2 | 10,44 |
| | 1,0 | 31355-7 | 11,58 |
| | 2,7 | 31360-1 | 31,32 |

| | |
|---------|-------|
| 31307-6 | 10,22 |
| 31312-0 | 11,32 |
| 31317-5 | 30,64 |
| 31322-9 | 10,50 |
| 31327-4 | 11,62 |
| 31332-8 | 31,36 |
| 31337-3 | 11,70 |
| 31342-7 | 13,04 |
| 31347-2 | 35,10 |
| 31352-6 | 11,28 |
| 31357-1 | 12,56 |
| 31362-5 | 33,90 |

07 Übergangprofil 37 x 4,5 mm, Aluminium eloxiert, seitlich gebohrt

connecting profile 37 x 4,5 mm,
 aluminium anodized,
 laterally drilled

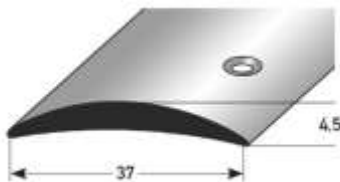

| | | | |
|---------------------------------------|-----|---------|-------|
| silberfarbig silver | 0,9 | 47700-6 | 9,40 |
| | 1,0 | 47702-0 | 10,40 |
| | 2,7 | 47704-4 | 28,10 |
| goldfarbig gold | 0,9 | 47712-9 | 9,60 |
| | 1,0 | 47714-3 | 10,64 |
| | 2,7 | 47716-7 | 28,80 |
| bronzefarbig hell bronze light | 0,9 | 47724-2 | 10,44 |
| | 1,0 | 47726-6 | 11,58 |
| | 2,7 | 47728-0 | 31,32 |
| bronzefarbig dunkel bronze dark | 0,9 | 47736-5 | 10,44 |
| | 1,0 | 47738-9 | 11,58 |
| | 2,7 | 47740-2 | 31,32 |

| | |
|---------|-------|
| 47706-8 | 10,22 |
| 47708-2 | 11,32 |
| 47710-5 | 30,64 |
| 47718-1 | 10,50 |
| 47720-4 | 11,62 |
| 47722-8 | 31,36 |
| 47730-3 | 11,70 |
| 47732-7 | 13,04 |
| 47734-1 | 35,10 |
| 47742-6 | 11,28 |
| 47744-0 | 12,56 |
| 47746-4 | 33,90 |

07 Übergangprofil 37 x 4,5 mm, Aluminium eloxiert, selbstklebend

connecting profile 37 x 4,5 mm,
 aluminium anodized,
 self-adhesive

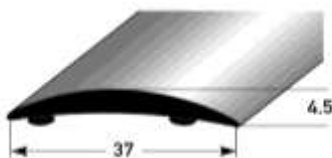

| | | | |
|---------------------------------------|-----|---------|-------|
| silberfarbig silver | 0,9 | 31306-9 | 11,30 |
| | 1,0 | 31311-3 | 12,58 |
| | 2,7 | 31316-8 | 33,94 |
| goldfarbig gold | 0,9 | 31321-2 | 11,56 |
| | 1,0 | 31326-7 | 12,80 |
| | 2,7 | 31331-1 | 34,66 |
| bronzefarbig hell bronze light | 0,9 | 31336-6 | 12,40 |
| | 1,0 | 31341-0 | 13,76 |
| | 2,7 | 31346-5 | 37,16 |
| bronzefarbig dunkel bronze dark | 0,9 | 31351-9 | 12,40 |
| | 1,0 | 31356-4 | 13,76 |
| | 2,7 | 31361-8 | 37,16 |

| | |
|---------|-------|
| 31308-3 | 11,86 |
| 31313-7 | 13,20 |
| 31318-2 | 35,64 |
| 31323-6 | 12,12 |
| 31328-1 | 13,44 |
| 31333-5 | 36,36 |
| 31338-0 | 12,96 |
| 31343-4 | 14,36 |
| 31348-9 | 38,84 |
| 31353-3 | 12,96 |
| 31358-8 | 14,36 |
| 31363-2 | 38,84 |

Beispiel: Übergangprofil 37 x 4,5 mm,
 Aluminium (siehe oben)
 example: connecting profile 37 x 4,5 mm,
 aluminium (see above)



4. ÜBERGANGSPROFILE/ 4. CONNECTING PROFILES

Seitlich gebohrt, ungebohrt oder als Flachstreifen auf Anfrage erhältlich!
 Laterally drilled, undrilled or as flat profil available on demand!

**02 Übergangprofil
 37 mm,
 Messing poliert,
 mit Schutzfolie**

connecting profile 37 mm,
 brass polished,
 with protective film



| Profi-Pack à 10 Stück im Bund | | | | SB-Pack incl. Schr./Dübel; VE 20 Stk. | | |
|--------------------------------|---|-----------|-----------|---|-----------|-------------|
| professional packing à 10 pcs. | | | | self-service-pack with screws/dowels; à 20 pcs. | | |
| | Dicke + Befestigung thickness + fixing | L / l (m) | Art./ref. | €/Stk./pcs. | Art./ref. | €/Stk./pcs. |
| 1,0 mm | mittig gebohrt centrally drilled | 0,9 | 06090-1 | 16,56 | 06091-8 | 17,64 |
| | | 1,0 | 06100-7 | 18,44 | 06101-4 | 19,52 |
| | | 2,0 | 06110-6 | 36,82 | | |
| | | 2,7 | 06120-5 | 49,72 | 06121-2 | 53,06 |
| | seitlich gebohrt laterally drilled | 0,9 | 06390-2 | 16,56 | 06391-9 | 17,64 |
| | | 1,0 | 06400-8 | 18,44 | 06401-5 | 19,52 |
| | | 2,0 | 06410-7 | 36,82 | | |
| | | 2,7 | 06420-6 | 49,72 | 06421-3 | 53,06 |
| | selbstklebend self-adhesive | 0,9 | 06093-2 | 18,26 | 06092-5 | 19,02 |
| | | 1,0 | 06103-8 | 20,08 | 06102-1 | 20,90 |
| | | 2,0 | 06123-6 | 57,48 | 06122-9 | 59,98 |
| | | | | | | |
| 1,2 mm | mittig gebohrt centrally drilled | 0,9 | 06095-6 | 18,30 | 06096-3 | 19,38 |
| | | 1,0 | 06105-2 | 20,32 | 06106-9 | 21,42 |
| | | 2,7 | 06125-0 | 54,90 | 06126-7 | 58,20 |
| | seitlich gebohrt laterally drilled | 0,9 | 06094-9 | 18,30 | 06099-4 | 19,38 |
| | | 1,0 | 06104-5 | 20,32 | 06109-0 | 21,42 |
| | | 2,7 | 06124-3 | 54,90 | 06129-8 | 58,20 |
| | selbstklebend self-adhesive | 0,9 | 06097-0 | 19,94 | 06098-7 | 20,80 |
| | | 1,0 | 06107-6 | 22,00 | 06108-3 | 22,80 |
| | | 2,7 | 06127-4 | 59,38 | 06128-1 | 61,82 |

**15 Übergangprofil
 37 mm,
 Edelstahl poliert,
 mit Schutzfolie**

connecting profile 37 mm,
 stainless steel polished,
 with protective film

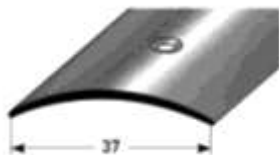

| | | | | | | |
|--------|---------------------------------------|---------|---------|---------|---------|-------|
| 1,0 mm | mittig gebohrt centrally drilled | 0,9 | 06190-8 | 5,80 | 06191-5 | 6,76 |
| | | 1,0 | 06200-4 | 6,44 | 06201-1 | 7,38 |
| | | 2,0 | 06210-3 | 12,84 | | |
| | | 2,7 | 06220-2 | 17,38 | 06221-9 | 20,22 |
| | seitlich gebohrt laterally drilled | 0,9 | 06490-9 | 5,80 | 06491-6 | 6,76 |
| | | 1,0 | 06500-5 | 6,44 | 06501-2 | 7,38 |
| | | 2,0 | 06510-4 | 12,84 | | |
| | selbstklebend self-adhesive | 2,7 | 06520-3 | 17,38 | 06521-0 | 20,22 |
| | | 0,9 | 06193-9 | 7,24 | 06192-2 | 7,94 |
| 1,0 | | 06203-5 | 7,86 | 06202-8 | 9,30 | |
| 1,5 mm | mittig gebohrt centrally drilled | 2,7 | 06223-3 | 21,18 | 06222-6 | 24,04 |
| | | 1,0 | 42490-1 | 7,88 | 42491-8 | 8,84 |
| | selbstklebend self-adhesive | 2,7 | 42500-7 | 21,28 | 42501-4 | 24,14 |
| 2,0 mm | mittig gebohrt centrally drilled | 1,0 | 42520-5 | 9,32 | 42521-2 | 10,04 |
| | | 2,7 | 42530-4 | 25,14 | 42531-1 | 27,98 |
| | selbstklebend self-adhesive | 1,0 | 42550-2 | 9,60 | 42551-9 | 10,56 |
| | | 2,7 | 42560-1 | 25,88 | 42561-8 | 28,74 |
| 2,0 mm | mittig gebohrt centrally drilled | 1,0 | 42580-9 | 11,06 | 42581-6 | 11,84 |
| | | 2,7 | 42590-8 | 29,78 | 42591-5 | 31,88 |
| | selbstklebend self-adhesive | | | | | |
| | | | | | | |

**16 Übergangprofil
 37 mm,
 Edelstahl matt,
 mit Schutzfolie**

connecting profile 37 mm,
 stainless steel matt,
 with protective film

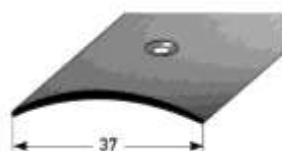

| | | | | | | |
|--------|---------------------------------------|-------|---------|-------|---------|-------|
| 1,0 mm | mittig gebohrt centrally drilled | 0,9 | 06690-3 | 7,98 | 06691-0 | 8,92 |
| | | 1,0 | 06700-9 | 8,88 | 06701-6 | 9,78 |
| | | 2,7 | 06720-7 | 23,92 | 06721-4 | 26,80 |
| | seitlich gebohrt laterally drilled | 0,9 | 06790-0 | 7,98 | 06791-7 | 8,92 |
| | | 1,0 | 06800-6 | 8,88 | 06801-3 | 9,78 |
| | | 2,7 | 06820-4 | 23,92 | 06821-1 | 26,80 |
| | selbstklebend self-adhesive | 0,9 | 06890-7 | 9,42 | 06891-4 | 10,14 |
| | | 1,0 | 06900-3 | 10,26 | 06901-0 | 11,02 |
| | | 2,7 | 06920-1 | 27,76 | 06921-8 | 30,64 |
| 1,5 mm | mittig gebohrt centrally drilled | 1,0 | 60025-1 | 11,86 | 42601-1 | 12,80 |
| | | 2,7 | 42600-4 | 32,12 | 42603-5 | 34,96 |
| | selbstklebend self-adhesive | 1,0 | 42610-3 | 13,32 | 42611-0 | 14,02 |
| 2,0 mm | mittig gebohrt centrally drilled | 2,7 | 42630-1 | 35,94 | 42631-8 | 38,82 |
| | | 1,0 | 60545-4 | 14,96 | 42641-7 | 15,88 |
| | selbstklebend self-adhesive | 2,7 | 42640-0 | 40,34 | 42643-1 | 43,18 |
| | | 1,0 | 42650-9 | 16,36 | 42651-6 | 17,10 |
| 2,7 | 42670-7 | 44,16 | 42671-4 | 47,04 | | |

4. ÜBERGANGSPROFILE/ 4. CONNECTING PROFILES

Andere Eloxalfarben siehe
Abschnitt 6, Lieferzeit 14 Tage/
other anodized colours see section 6,
delivery time 14 days

| Profi-Pack à 10 Stück im Bund | | | |
|--------------------------------|-----------|-----------|-------------|
| professional packing à 10 pcs. | | | |
| Farbe/colour | L / l (m) | Art./ref. | €/Stk./pcs. |

| SB-Pack incl. Schr./ Dübel; VE 20 Stk. | |
|---|-------------|
| self-service-pack with screws/ dowels; à 20 pcs. | |
| Art./ref. | €/Stk./pcs. |

1 2 Übergangsprofil 38 x 1,8 mm, Aluminium eloxiert, gebohrt

connecting profile 38 x 1,8 mm,
aluminium anodized,
drilled

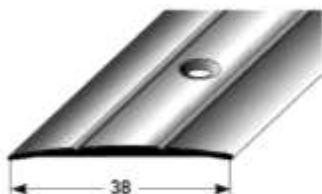

| | | | |
|---|-----|---------|-------|
| silberfarbig silver | 0,9 | 23490-6 | 4,58 |
| | 1,0 | 23500-2 | 5,10 |
| | 2,0 | 23510-1 | 10,20 |
| | 2,7 | 23520-0 | 13,76 |
| goldfarbig gold | 0,9 | 23590-3 | 6,48 |
| | 1,0 | 23600-9 | 7,22 |
| | 2,0 | 23610-8 | 14,38 |
| | 2,7 | 23620-7 | 19,46 |
| bronzefarbig hell bronze light | 0,9 | 23690-0 | 6,92 |
| | 1,0 | 23700-6 | 7,70 |
| | 2,0 | 23710-5 | 15,34 |
| | 2,7 | 23720-4 | 20,74 |
| bronzefarbig dunkel bronze dark | 0,9 | 23790-7 | 6,92 |
| | 1,0 | 23800-3 | 7,70 |
| | 2,0 | 23810-2 | 15,34 |
| | 2,7 | 23820-1 | 20,74 |
| edelstahlfarbig Feinschliff fine-honed stainless steel coloured | 0,9 | 71930-4 | 6,92 |
| | 1,0 | 71932-8 | 7,70 |
| | 2,7 | 71934-2 | 20,74 |
| schwarz black | 1,0 | 72094-2 | 7,70 |
| | 2,7 | 72096-6 | 20,74 |

| | |
|---------|-------|
| 23491-3 | 5,42 |
| 23501-9 | 6,00 |
| | |
| 23521-7 | 16,24 |
| 23591-0 | 7,36 |
| 23601-6 | 8,16 |
| | |
| 23621-4 | 22,08 |
| 23691-7 | 8,16 |
| 23701-3 | 9,08 |
| | |
| 23721-1 | 24,54 |
| 23791-4 | 7,76 |
| 23801-0 | 8,64 |
| | |
| 23821-8 | 23,28 |
| 71936-6 | 8,16 |
| 71938-0 | 9,08 |
| 71940-3 | 24,54 |
| 72098-0 | 8,64 |
| 72100-0 | 23,28 |

Holzdekorfolie/ wood decor

| | | | |
|------------------------------|-----|---------|-------|
| Buche beech | 1,0 | 38340-6 | 12,30 |
| | 2,7 | 38350-5 | 33,26 |
| Eiche oak | 1,0 | 38360-4 | 12,30 |
| | 2,7 | 38370-3 | 33,26 |
| Ahorn maple | 1,0 | 38380-2 | 12,30 |
| | 2,7 | 38390-1 | 33,26 |
| Kirschbaum cherry wood | 1,0 | 38400-7 | 12,30 |
| | 2,7 | 38405-2 | 33,26 |
| Eiche rustikal rustic oak | 1,0 | 38410-6 | 12,30 |
| | 2,7 | 38415-1 | 33,26 |

| | |
|---------|-------|
| 38341-3 | 13,28 |
| 38351-2 | 35,90 |
| 38361-1 | 13,28 |
| 38371-0 | 35,90 |
| 38381-9 | 13,28 |
| 38391-8 | 35,90 |
| 38401-4 | 13,28 |
| 38406-9 | 35,90 |
| 38411-3 | 13,28 |
| 38416-8 | 35,90 |

4. ÜBERGANGSPROFILE/ 4. CONNECTING PROFILES

Andere Eloxalfarben siehe
 Abschnitt 6, Lieferzeit 14 Tage/
 other anodized colours see section 6,
 delivery time 14 days

12 Übergangsprofil 38 x 1,8 mm, Aluminium eloxiert, selbstklebend

connecting profile 38 x 1,8 mm,
 aluminium anodized,
 self-adhesive

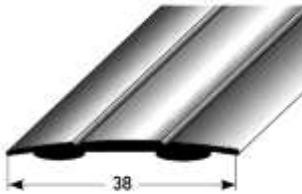

| Profi-Pack à 10 Stück im Bund | | | |
|--------------------------------|-----------|-----------|-------------|
| professional packing à 10 pcs. | | | |
| Farbe/colour | L / l (m) | Art./ref. | €/Stk./pcs. |

| SB-Pack incl. Schr./ Dübel; VE 20 Stk. | |
|---|-------------|
| self-service-pack with screws/ dowels; à 20 pcs. | |
| Art./ref. | €/Stk./pcs. |

| | | | |
|---|-----|---------|-------|
| silberfarbig silver | 0,9 | 23493-7 | 6,46 |
| | 1,0 | 23503-3 | 7,16 |
| | 2,7 | 23523-1 | 19,42 |
| goldfarbig gold | 0,9 | 23593-4 | 8,46 |
| | 1,0 | 23603-0 | 9,42 |
| | 2,7 | 23623-8 | 25,32 |
| bronzefarbig hell bronze light | 0,9 | 23693-1 | 8,88 |
| | 1,0 | 23703-7 | 9,82 |
| | 2,7 | 23723-5 | 26,60 |
| bronzefarbig dunkel bronze dark | 0,9 | 23793-8 | 8,88 |
| | 1,0 | 23803-4 | 9,82 |
| | 2,7 | 23823-2 | 26,60 |
| edelstahlfarbig Feinschliff fine-honed stainless steel coloured | 0,9 | 71942-7 | 8,88 |
| | 1,0 | 71944-1 | 9,82 |
| | 2,7 | 71946-5 | 26,60 |
| schwarz black | 1,0 | 72102-4 | 9,82 |
| | 2,7 | 72104-8 | 26,60 |

| | |
|---------|-------|
| 23492-0 | 7,04 |
| 23502-6 | 7,78 |
| 23522-4 | 21,18 |
| 23592-7 | 9,00 |
| 23602-3 | 10,02 |
| 23622-1 | 27,04 |
| 23692-4 | 9,46 |
| 23702-0 | 10,52 |
| 23722-8 | 28,28 |
| 23792-1 | 9,46 |
| 23802-7 | 10,52 |
| 23822-5 | 28,28 |
| 71948-9 | 9,46 |
| 68004-8 | 10,52 |
| 68006-2 | 28,28 |
| 72106-2 | 10,52 |
| 72108-6 | 28,28 |

| | | | |
|------------------------------|-----|---------|-------|
| Buche beech | 1,0 | 38280-5 | 14,88 |
| | 2,7 | 38290-4 | 40,16 |
| Eiche oak | 1,0 | 38300-0 | 14,88 |
| | 2,7 | 38310-9 | 40,16 |
| Ahorn maple | 1,0 | 38320-8 | 14,88 |
| | 2,7 | 38330-7 | 40,16 |
| Kirschbaum cherry wood | 1,0 | 38420-5 | 14,88 |
| | 2,7 | 38425-0 | 40,16 |
| Eiche rustikal rustic oak | 1,0 | 38430-4 | 14,88 |
| | 2,7 | 38435-9 | 40,16 |

| | |
|---------|-------|
| 38281-2 | 15,50 |
| 38291-1 | 41,84 |
| 38301-7 | 15,50 |
| 38311-6 | 41,84 |
| 38321-5 | 15,50 |
| 38331-4 | 41,84 |
| 38421-2 | 15,50 |
| 38426-7 | 41,84 |
| 38431-1 | 15,50 |
| 38436-6 | 41,84 |

Holzdekorfolie/ wood decor

4. ÜBERGANGSPROFILE/ 4. CONNECTING PROFILES

Andere Eloxalfarben siehe
Abschnitt 6, Lieferzeit 14 Tage/
other anodized colours see section 6,
delivery time 14 days

| Profi-Pack à 10 Stück im Bund | | | |
|--------------------------------|-----------|-----------|-------------|
| professional packing à 10 pcs. | | | |
| Befestigung/ fixing | L / l (m) | Art./ref. | €/Stk./pcs. |

| SB-Pack incl. Schr./ Dübel; VE 20 Stk. | |
|---|-------------|
| self-service-pack with screws/ dowels; à 20 pcs. | |
| Art./ref. | €/Stk./pcs. |

03 Übergangprofil 48 x 2 mm, Messing poliert

connecting profile 48 x 2 mm, brass polished



| | | | | | |
|---------------------------------------|-----|---------|--------|---------|---------|
| mittig gebohrt centrally drilled | 1,0 | 28761-2 | 47,38 | 28763-6 | 48,72 |
| | 2,5 | 28760-5 | 118,46 | | 28762-9 |
| seitlich gebohrt laterally drilled | 1,0 | 48060-0 | 47,38 | 48064-8 | 48,72 |
| | 2,5 | 48062-4 | 118,46 | | 48066-2 |
| selbstklebend self-adhesive | 1,0 | 48070-9 | 49,74 | 48074-7 | 50,82 |
| | 2,5 | 48072-3 | 124,34 | | 48076-1 |

| | |
|---------|---------|
| 28763-6 | 48,72 |
| | 28762-9 |
| 48064-8 | 48,72 |
| | 48066-2 |
| 48074-7 | 50,82 |
| | 48076-1 |

155 Übergangprofil 50 x 1,5 mm, Edelstahl matt, gewölbt

connecting profile 50 x 1,5 mm, stainless steel matt, curved

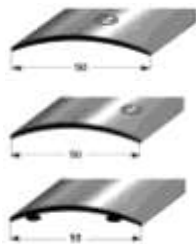

| | | | | | |
|---------------------------------------|-----|---------|-------|---------|---------|
| mittig gebohrt centrally drilled | 1,0 | 63000-5 | 27,04 | 63010-4 | 29,66 |
| | 2,7 | 63005-0 | 73,04 | | 63015-9 |
| seitlich gebohrt laterally drilled | 1,0 | 63020-3 | 27,04 | 63030-2 | 29,66 |
| | 2,7 | 63025-8 | 73,04 | | 63035-7 |
| selbstklebend self-adhesive | 1,0 | 63040-1 | 29,30 | 63050-0 | 31,88 |
| | 2,7 | 63045-6 | 73,30 | | 63055-5 |

| | |
|---------|---------|
| 63010-4 | 29,66 |
| | 63015-9 |
| 63030-2 | 29,66 |
| | 63035-7 |
| 63050-0 | 31,88 |
| | 63055-5 |

145 Übergangprofil 50 x 4 mm, Aluminium eloxiert, mittig gebohrt, für starke Belastungen

connecting profile 50 x 4 mm,
aluminium anodized, heavy duty,
centrally drilled



| Farbe/colour | | | | | |
|--------------------------------|-----|---------|-------|---------|---------|
| silberfarbig silver | 1,0 | 42820-6 | 14,28 | 42830-5 | 15,26 |
| | 2,7 | 42825-1 | 38,64 | | 42835-0 |
| goldfarbig gold | 1,0 | 42840-4 | 14,80 | 42850-3 | 15,78 |
| | 2,7 | 42845-9 | 39,94 | | 42855-8 |
| bronzef. hell bronze light | 1,0 | 42860-2 | 15,80 | 42870-1 | 17,16 |
| | 2,7 | 42865-7 | 42,54 | | 42875-6 |
| bronzef. dunkel bronze dark | 1,0 | 42880-0 | 15,80 | 42890-9 | 16,76 |
| | 2,7 | 42885-5 | 42,54 | | 42895-4 |

| | |
|---------|---------|
| 42830-5 | 15,26 |
| | 42835-0 |
| 42850-3 | 15,78 |
| | 42855-8 |
| 42870-1 | 17,16 |
| | 42875-6 |
| 42890-9 | 16,76 |
| | 42895-4 |

145 Übergangprofil 50 x 4 mm, Aluminium eloxiert, seitlich gebohrt, für starke Belastungen

connecting profile 50 x 4 mm,
aluminium anodized, heavy duty,
laterally drilled



| | | | | | |
|--------------------------------|-----|---------|-------|---------|---------|
| silberfarbig silver | 1,0 | 47818-8 | 14,28 | 47822-5 | 15,26 |
| | 2,7 | 47820-1 | 38,64 | | 47824-9 |
| goldfarbig gold | 1,0 | 47826-3 | 14,80 | 47830-0 | 15,78 |
| | 2,7 | 47828-7 | 39,94 | | 47832-4 |
| bronzef. hell bronze light | 1,0 | 47834-8 | 15,80 | 47838-6 | 17,16 |
| | 2,7 | 47836-2 | 42,54 | | 47840-9 |
| bronzef. dunkel bronze dark | 1,0 | 47842-3 | 15,80 | 47846-1 | 16,76 |
| | 2,7 | 47844-7 | 42,54 | | 47848-5 |

| | |
|---------|---------|
| 47822-5 | 15,26 |
| | 47824-9 |
| 47830-0 | 15,78 |
| | 47832-4 |
| 47838-6 | 17,16 |
| | 47840-9 |
| 47846-1 | 16,76 |
| | 47848-5 |

145 Übergangprofil 50 x 4 mm, Aluminium eloxiert, selbstklebend, für starke Belastungen

connecting profile 50 x 4 mm,
aluminium anodized, heavy duty,
self-adhesive



| | | | | | |
|--------------------------------|-----|---------|-------|---------|---------|
| silberfarbig silver | 1,0 | 47750-1 | 16,44 | 47754-9 | 17,10 |
| | 2,7 | 47752-5 | 44,50 | | 47756-3 |
| goldfarbig gold | 1,0 | 47758-7 | 17,00 | 47762-4 | 17,56 |
| | 2,7 | 47760-0 | 45,80 | | 47764-8 |
| bronzef. hell bronze light | 1,0 | 47766-2 | 17,96 | 47770-9 | 19,02 |
| | 2,7 | 47768-6 | 48,44 | | 47772-3 |
| bronzef. dunkel bronze dark | 1,0 | 47774-7 | 17,96 | 47778-5 | 19,02 |
| | 2,7 | 47776-1 | 48,44 | | 47780-8 |

| | |
|---------|---------|
| 47754-9 | 17,10 |
| | 47756-3 |
| 47762-4 | 17,56 |
| | 47764-8 |
| 47770-9 | 19,02 |
| | 47772-3 |
| 47778-5 | 19,02 |
| | 47780-8 |

4. ÜBERGANGSPROFILE/ 4. CONNECTING PROFILES

Andere Eloxalfarben siehe
Abschnitt 6, Lieferzeit 14 Tage/
other anodized colours see section 6,
delivery time 14 days

| Profi-Pack à 10 Stück im Bund | | | |
|--------------------------------|-----------|-----------|-------------|
| professional packing à 10 pcs. | | | |
| Befestigung/ fixing | L / l (m) | Art./ref. | €/Stk./pcs. |

| SB-Pack incl. Schr./ Dübel; VE 20 Stk. | |
|---|-------------|
| self-service-pack with screws/ dowels; à 20 pcs. | |
| Art./ref. | €/Stk./pcs. |

04 Übergangsprofil 57 x 2 mm, Messing poliert

connecting profile 57 x 2 mm, brass polished

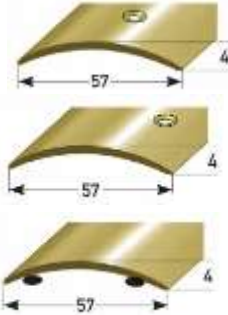

| | | | | | |
|-------------------------------------|-----|---------|--------|---------|-------|
| mittig gebohrt centrally drilled | 1,0 | 28771-1 | 50,84 | 28773-5 | 52,16 |
| | 2,5 | 28770-4 | 127,10 | | |

| | | | | | |
|---------------------------------------|-----|---------|--------|---------|-------|
| seitlich gebohrt laterally drilled | 1,0 | 48080-8 | 50,84 | 48084-6 | 52,16 |
| | 2,5 | 48082-2 | 127,10 | | |

| | | | | | |
|--------------------------------|-----|---------|--------|---------|-------|
| selbstklebend self-adhesive | 1,0 | 48090-7 | 53,24 | 48094-5 | 54,28 |
| | 2,5 | 48092-1 | 133,16 | | |

08 Übergangsprofil 58 x 4 mm, Aluminium eloxiert, mittig gebohrt, für starke Belastungen

connecting profile 58 x 4 mm,
aluminium anodized, heavy duty,
centrally drilled



| Farbe/colour | | | | | |
|--------------------------------|-----|---------|-------|---------|-------|
| silberfarbig silver | 1,0 | 31600-8 | 16,46 | 31601-5 | 17,42 |
| | 2,7 | 31605-3 | 44,52 | | |
| goldfarbig gold | 1,0 | 31610-7 | 17,06 | 31611-4 | 18,04 |
| | 2,7 | 31615-2 | 46,06 | | |
| bronzef. hell bronze light | 1,0 | 31620-6 | 18,24 | 31621-3 | 19,60 |
| | 2,7 | 31625-1 | 49,14 | | |
| bronzef. dunkel bronze dark | 1,0 | 31630-5 | 18,24 | 31631-2 | 19,18 |
| | 2,7 | 31635-0 | 49,14 | | |

| | |
|---------|-------|
| 31601-5 | 17,42 |
| | |
| 31611-4 | 18,04 |
| | |
| 31621-3 | 19,60 |
| | |
| 31631-2 | 19,18 |
| | |

08 Übergangsprofil 58 x 4 mm, Aluminium eloxiert, seitlich gebohrt, für starke Belastungen

connecting profile 58 x 4 mm,
aluminium anodized, heavy duty,
laterally drilled



| | | | | | |
|--------------------------------|-----|---------|-------|---------|-------|
| silberfarbig silver | 1,0 | 47852-2 | 16,46 | 47856-0 | 17,42 |
| | 2,7 | 47854-6 | 44,52 | | |
| goldfarbig gold | 1,0 | 47860-7 | 17,06 | 47864-5 | 18,04 |
| | 2,7 | 47862-1 | 46,06 | | |
| bronzef. hell bronze light | 1,0 | 47868-3 | 18,24 | 47872-0 | 19,60 |
| | 2,7 | 47870-6 | 49,14 | | |
| bronzef. dunkel bronze dark | 1,0 | 47876-8 | 18,24 | 47880-5 | 19,18 |
| | 2,7 | 47878-2 | 49,14 | | |

| | |
|---------|-------|
| 47856-0 | 17,42 |
| | |
| 47864-5 | 18,04 |
| | |
| 47872-0 | 19,60 |
| | |
| 47880-5 | 19,18 |
| | |

08 Übergangsprofil 58 x 4 mm, Aluminium eloxiert, selbstklebend, für starke Belastungen

connecting profile 58 x 4 mm,
aluminium anodized, heavy duty,
self-adhesive



| | | | | | |
|--------------------------------|-----|---------|-------|---------|-------|
| silberfarbig silver | 1,0 | 47784-6 | 20,50 | 47788-4 | 20,74 |
| | 2,7 | 47786-0 | 55,30 | | |
| goldfarbig gold | 1,0 | 47792-1 | 21,08 | 47796-9 | 21,32 |
| | 2,7 | 47794-5 | 56,86 | | |
| bronzef. hell bronze light | 1,0 | 47800-3 | 22,22 | 47804-1 | 22,86 |
| | 2,7 | 47802-7 | 59,96 | | |
| bronzef. dunkel bronze dark | 1,0 | 47808-9 | 22,22 | 47812-6 | 22,86 |
| | 2,7 | 47810-2 | 59,96 | | |

| | |
|---------|-------|
| 47788-4 | 20,74 |
| | |
| 47796-9 | 21,32 |
| | |
| 47804-1 | 22,86 |
| | |
| 47812-6 | 22,86 |
| | |

4. ÜBERGANGSPROFILE/ 4. CONNECTING PROFILES

Andere Eloxalfarben siehe
 Abschnitt 6, Lieferzeit 14 Tage/
 other anodized colours see section 6,
 delivery time 14 days

| Profi-Pack à 10 Stück im Bund | | | |
|--------------------------------|-----------|-----------|-------------|
| professional packing à 10 pcs. | | | |
| Farbe/colour | L / l (m) | Art./ref. | €/Stk./pcs. |

| SB-Pack incl. Schr./ Dübel; VE 20 Stk. | |
|---|-------------|
| self-service-pack with screws/ dowels; à 20 pcs. | |
| Art./ref. | €/Stk./pcs. |

350 Übergangprofil 80 x 3,5 mm, Aluminium eloxiert, mittig gebohrt

connecting profile 80 x 3,5 mm,
 aluminium anodized,
 centrally drilled

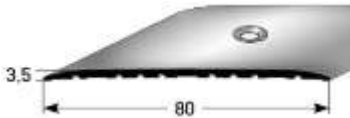

| | | | | | |
|--------------------------------|-----|---------|-------|---------|-------|
| silberfarbig silver | 1,0 | 65400-1 | 18,46 | 65416-2 | 19,38 |
| | 2,7 | 65402-5 | 49,80 | | |
| goldfarbig gold | 1,0 | 65404-9 | 18,86 | 65418-6 | 52,60 |
| | 2,7 | 65406-3 | 50,92 | | |
| bronzef. hell bronze light | 1,0 | 65408-7 | 21,02 | 65420-9 | 19,78 |
| | 2,7 | 65410-0 | 56,70 | | |
| bronzef. dunkel bronze dark | 1,0 | 65412-4 | 21,02 | 65422-3 | 53,68 |
| | 2,7 | 65414-8 | 56,70 | | |

| | |
|---------|-------|
| 65424-7 | 21,92 |
| 65426-1 | 59,52 |
| 65428-5 | 21,92 |
| 65430-8 | 59,52 |

350 Übergangprofil 80 x 3,5 mm, Aluminium eloxiert, seitlich gebohrt

connecting profile 80 x 3,5 mm,
 aluminium anodized,
 laterally drilled

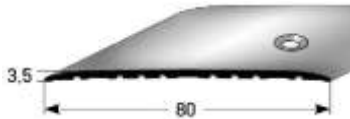

| | | | | | |
|--------------------------------|-----|---------|-------|---------|-------|
| silberfarbig silver | 1,0 | 65434-6 | 18,46 | 65450-6 | 19,38 |
| | 2,7 | 65436-0 | 49,80 | | |
| goldfarbig gold | 1,0 | 65438-4 | 18,86 | 65452-0 | 52,60 |
| | 2,7 | 65440-7 | 50,92 | | |
| bronzef. hell bronze light | 1,0 | 65442-1 | 21,02 | 65454-4 | 19,78 |
| | 2,7 | 65444-5 | 56,70 | | |
| bronzef. dunkel bronze dark | 1,0 | 65446-9 | 21,02 | 65456-8 | 53,68 |
| | 2,7 | 65448-3 | 56,70 | | |

| | |
|---------|-------|
| 65458-2 | 21,92 |
| 65460-5 | 59,52 |
| 65462-9 | 21,92 |
| 65464-3 | 59,52 |

350 Übergangprofil 80 x 3,5 mm, Aluminium eloxiert, selbstklebend

connecting profile 80 x 3,5 mm,
 aluminium anodized,
 self-adhesive

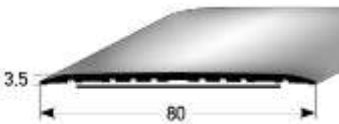

| | | | | | |
|--------------------------------|-----|---------|-------|---------|-------|
| silberfarbig silver | 1,0 | 65468-1 | 22,32 | 65484-1 | 22,88 |
| | 2,7 | 65470-4 | 60,30 | | |
| goldfarbig gold | 1,0 | 65472-8 | 22,76 | 65486-5 | 62,04 |
| | 2,7 | 65474-2 | 61,42 | | |
| bronzef. hell bronze light | 1,0 | 65476-6 | 24,90 | 65488-9 | 23,32 |
| | 2,7 | 65478-0 | 67,24 | | |
| bronzef. dunkel bronze dark | 1,0 | 65480-3 | 24,90 | 65490-2 | 63,12 |
| | 2,7 | 65482-7 | 67,24 | | |

| | |
|---------|-------|
| 65492-6 | 25,46 |
| 65494-0 | 68,94 |
| 65496-4 | 25,46 |
| 65498-8 | 68,94 |

wechselseitig gebohrt auf Anfrage

alternating sides drilled on request

4. ÜBERGANGSPROFILE / 4. CONNECTING PROFILES

| Profi-Pack à 10 Stück im Bund | | | | SB-Pack incl. Schr./Dübel; VE 20 Stk. | |
|--------------------------------|-----------|-----------|-------------|---|-------------|
| professional packing à 10 pcs. | | | | self-service-pack with screws/dowels; à 20 pcs. | |
| Befestigung/fixing | L / l (m) | Art./ref. | €/Stk./pcs. | Art./ref. | €/Stk./pcs. |

439 Edelstahl-Übergangsprofil 27 x 1,5 mm, profilierte Riffelung, matt

stainless steel connecting profile 27 x 1,8 mm, fluted profile, matt

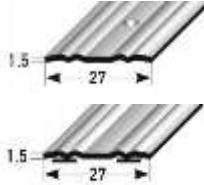

| | | | | | |
|-------------------------------------|-----|---------|-------|---------|-------|
| mittig gebohrt centrally drilled | 1,0 | 68270-7 | 11,58 | 68282-0 | 12,52 |
| | 2,7 | 68272-1 | 31,30 | 68284-4 | 33,84 |
| selbstklebend self-adhesive | 1,0 | 68276-9 | 13,32 | 68288-2 | 14,02 |
| | 2,7 | 68278-3 | 35,98 | 68290-5 | 38,52 |

440 Edelstahl-Übergangsprofil 38 x 1,5 mm, profilierte Riffelung, matt

stainless steel connecting profile 38 x 1,8 mm, fluted profile, matt

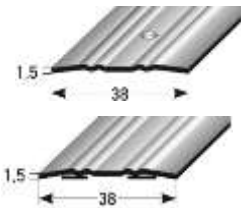

| | | | | | |
|-------------------------------------|-----|---------|-------|---------|-------|
| mittig gebohrt centrally drilled | 1,0 | 68300-1 | 14,22 | 68312-4 | 15,16 |
| | 2,7 | 68302-5 | 38,46 | 68314-8 | 41,00 |
| selbstklebend self-adhesive | 1,0 | 68306-3 | 16,00 | 68318-6 | 16,68 |
| | 2,7 | 68308-7 | 43,16 | 68320-9 | 45,04 |

441 Übergangsprofil 30 x 3,5 mm, Edelstahl V4A gezogen, gebohrt

drawn stainless steel connecting profile V4A 30 x 3,5 mm, drilled

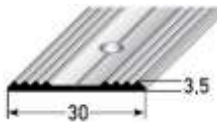

| | | | | | |
|-------------------------------------|-----|---------|--------|---------|--------|
| mittig gebohrt centrally drilled | 1,0 | 68330-8 | 83,72 | 68336-0 | 86,22 |
| | 2,5 | 68332-2 | 209,32 | 68338-4 | 216,80 |

Edelstahlschrauben siehe
Abschnitt 12/
stainless steel screws see
section 12

Edelstahl-Übergangsprofile INOX PROTECT zur Verlegung mit Einlage 39 mm

| | | | |
|--|---------|-----------|-------------|
| stainless steel connecting profiles for installation with insert 39 mm | | | |
| L / l (m) | VE/unit | Art./ref. | €/Stk./pcs. |

412 Übergangsprofil 70 x 1,5 mm INOX PROTECT, Edelstahl matt, gebohrt

connecting profile INOX PROTECT 70 x 1,5 mm, stainless steel matt, drilled



| | | | |
|-------|-----------------|---------|--------|
| 1,0 m | 1 Stück/pcs. | 67034-6 | 37,86 |
| 2,5 m | | 67036-0 | 94,62 |
| 3,0 m | | 67038-4 | 113,60 |

für Verlegung mit Einlage 39 mm, siehe Seite 23
for installation with insert 39 mm, see page 23

**3,0 m-Ware ist nur per Spedition lieferbar
(gesonderte Transportkosten)**
3,0 m profiles are only available per forwarding agency
(separate transport costs)



Übergangsprofil INOX PROTECT mit Einlage 39 mm,
Easy-Clean, gelb-schwarz (siehe oben bzw. Seite 23)
connecting profile INOX PROTECT with insert 39 mm,
Easy-Clean, yellow-black (see above and page 23)

4. ÜBERGANGSPROFILE/ 4. CONNECTING PROFILES

Andere Abmaße auf Anfrage/ other dimensions on demand

| gekantete Übergangprofile aus Edelstahl, matt gebürstet | | | | | |
|---|-----------|---------------------------|-------------|---------------------------|-------------|
| edged connecting profiles, stainless steel matt brushed | | | | | |
| Breite/ width (mm) | L / l (m) | 1,5 mm | | 2,0 mm | |
| | | Materialstärke/ thickness | | Materialstärke/ thickness | |
| | | Art./ref. | €/Stk./pcs. | Art./ref. | €/Stk./pcs. |

Übergangspr. 1,5 / 2,0 / 3,0 mm, Edelstahl matt, gekantet **250**

136

connecting profile
 1,5/ 2,0/ 3,0 mm,
 stainless steel matt, edged

| | | | |
|-------|------|---------|-------|
| 50 mm | 1,00 | 60045-9 | 25,68 |
| | 1,25 | 60050-3 | 32,20 |
| | 2,50 | 60060-2 | 64,24 |

| | |
|---------|-------|
| 60560-7 | 34,30 |
| 60565-2 | 42,86 |
| 60570-6 | 85,70 |

Bitte Befestigungstyp angeben:

- 01 mittig gebohrt
- 02 seitlich gebohrt
- 03 wechselseitig seitlich
- 04 ungebohrt
- 05 selbstklebend

| | | | |
|-------|------|---------|-------|
| 60 mm | 1,00 | 60065-7 | 30,84 |
| | 1,25 | 60070-1 | 38,54 |
| | 2,50 | 60080-0 | 77,02 |

| | |
|---------|--------|
| 60575-1 | 41,04 |
| 60580-5 | 51,40 |
| 60585-0 | 102,72 |

| | | | |
|-------|------|---------|-------|
| 70 mm | 1,00 | 60085-5 | 35,98 |
| | 1,25 | 60090-9 | 44,98 |
| | 2,50 | 60100-5 | 89,90 |

| | |
|---------|--------|
| 60590-4 | 47,94 |
| 60595-9 | 59,98 |
| 60600-0 | 119,84 |

Please specify fixing:

- 01 drilled centrally
- 02 drilled laterally
- 03 alternating sides drilled
- 04 undrilled
- 05 self adhesive

| | | | |
|-------|------|---------|--------|
| 80 mm | 1,00 | 60105-0 | 41,10 |
| | 1,25 | 60110-4 | 51,42 |
| | 2,50 | 60120-3 | 102,74 |

| | |
|---------|--------|
| 60605-5 | 54,80 |
| 60610-9 | 68,52 |
| 60615-4 | 136,96 |

| | | | |
|--------|------|---------|--------|
| 100 mm | 1,00 | 60125-8 | 51,40 |
| | 1,25 | 60130-2 | 64,22 |
| | 2,50 | 60140-1 | 128,42 |

| | |
|---------|--------|
| 60620-8 | 68,52 |
| 60625-3 | 85,64 |
| 60630-7 | 171,26 |

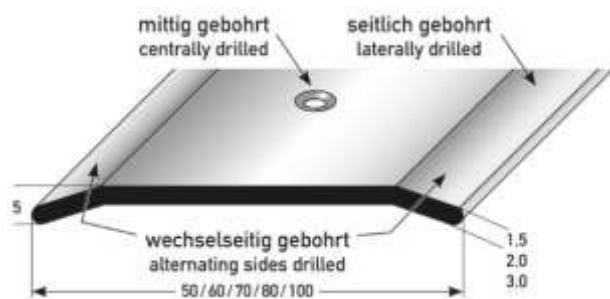

237

| Breite/ width (mm) | L / l (m) | 3,0 mm | |
|--------------------|-----------|-----------|-------------|
| | | Art./ref. | €/Stk./pcs. |
| 60 mm | 1,00 | 60700-7 | 61,62 |
| | 1,25 | 60705-2 | 77,02 |
| | 2,50 | 60710-6 | 154,08 |

238

| | | | |
|-------|------|---------|--------|
| 70 mm | 1,00 | 60715-1 | 71,92 |
| | 1,25 | 60720-5 | 89,92 |
| | 2,50 | 60725-0 | 179,80 |

239

| | | | |
|-------|------|---------|--------|
| 80 mm | 1,00 | 60730-4 | 82,18 |
| | 1,25 | 60735-9 | 102,74 |
| | 2,50 | 60740-3 | 205,48 |

240

| | | | |
|--------|------|---------|--------|
| 100 mm | 1,00 | 60745-8 | 102,74 |
| | 1,25 | 60750-2 | 128,44 |
| | 2,50 | 60755-7 | 256,90 |

Bohrungen bis 2 mm Stärke für 3,5 mm Schrauben;
Bohrungen bei 3 mm Stärke für 4 mm Schrauben
 holes up to 2 mm thickness for 3.5 mm screws;
 drilling at 3 mm for 4 mm screws

Edelstahlschrauben siehe Abschnitt 12/
 stainless steel screws see section 12

8. SOCKELLEISTEN/ 8. SKIRTINGS

Andere Abmaße auf Anfrage/ other dimensions on demand

| Aluminium-Flachschwellen | | | | | | | | |
|---------------------------|--------------|--|--------|-----------|------------------|-----|------------------|-----|
| aluminium flat thresholds | | | | | | | | |
| Breite/ width A (mm) | Farbe/colour | | AxB mm | L / l (m) | gebohrt/ drilled | €/m | ohne alles/ bare | €/m |

Flachschwellen 1,5 / 2,0 / 3,0 / 5,0 mm, Aluminium

flat threshold
 1,5/ 2,0/ 3,0/
 5,0 mm, aluminium



Seitlich oder wechselseitig gebohrt auf Anfrage.
 Laterally or alternately drilled on request.

| | | | | | | | | |
|--------|--|-----|-----------|------|---------|---------|---------|---------|
| 40 mm | silber elox. silver anodized | 457 | 40 x 1,0 | 2,5 | 68744-3 | 7,48/m | 68752-8 | 5,72/m |
| | | 538 | 40 x 2,0 | 2,5 | 68746-7 | 13,22/m | 68754-2 | 11,50/m |
| | | 539 | 40 x 3,0 | 2,5* | 68748-1 | 19,00/m | 68756-6 | 17,24/m |
| | edelstahl-farbig stainless steel coloured | | 40 x 1,0 | 2,5* | 68768-9 | 9,70/m | 68776-4 | 7,98/m |
| | | | 40 x 2,0 | 2,5* | 68770-2 | 15,46/m | 68778-8 | 13,72/m |
| | | | 40 x 3,0 | 2,5* | 68772-6 | 21,22/m | 68780-1 | 19,50/m |
| 50 mm | silber elox. silver anodized | 458 | 50 x 1,0 | 2,5 | 68816-7 | 8,92/m | 68824-2 | 7,18/m |
| | | 540 | 50 x 2,0 | 2,5 | 68818-1 | 16,12/m | 68826-6 | 14,38/m |
| | | 541 | 50 x 3,0 | 2,5* | 68820-4 | 22,80/m | 68828-0 | 21,08/m |
| | edelstahl-farbig stainless steel coloured | | 50 x 1,0 | 2,5* | 68840-2 | 10,90/m | 68848-8 | 9,16/m |
| | | | 50 x 2,0 | 2,5* | 68842-6 | 18,34/m | 68850-1 | 16,62/m |
| | | | 50 x 3,0 | 2,5* | 68844-0 | 24,98/m | 68852-5 | 23,26/m |
| 60 mm | silber elox. silver anodized | 298 | 60 x 1,0 | 2,5 | 61924-6 | 10,74/m | 61930-7 | 9,22/m |
| | | 428 | 60 x 2,0 | 2,5 | 67246-3 | 17,12/m | 67252-4 | 14,54/m |
| | | 299 | 60 x 3,0 | 2,5* | 61944-4 | 23,96/m | 61950-5 | 22,38/m |
| | | 300 | 60 x 5,0 | 3,0* | 61964-2 | 36,78/m | 61970-3 | 35,18/m |
| | edelstahl-farbig stainless steel coloured | | 60 x 1,0 | 2,5* | 61926-0 | 12,76/m | 61932-1 | 11,18/m |
| | | | 60 x 2,0 | 2,5* | 67248-7 | 22,08/m | 67254-8 | 20,54/m |
| | | | 60 x 3,0 | 2,5* | 61946-8 | 25,98/m | 61952-9 | 24,40/m |
| | | | 60 x 5,0 | 3,0* | 61966-6 | 38,78/m | 61972-7 | 37,20/m |
| 80 mm | silber elox. silver anodized | 542 | 80 x 1,0 | 2,5 | 68888-4 | 13,22/m | 68896-9 | 11,50/m |
| | | 543 | 80 x 2,0 | 2,5 | 68890-7 | 24,74/m | 68898-3 | 23,02/m |
| | | 544 | 80 x 3,0 | 2,5* | 68892-1 | 36,24/m | 68900-3 | 34,50/m |
| | edelstahl-farbig stainless steel coloured | | 80 x 1,0 | 2,5* | 68912-6 | 16,20/m | 68920-1 | 14,48/m |
| | | | 80 x 2,0 | 2,5* | 68914-0 | 27,72/m | 68922-5 | 25,98/m |
| | | | 80 x 3,0 | 2,5* | 68916-4 | 39,22/m | 68924-9 | 37,44/m |
| 100 mm | silber elox. silver anodized | 545 | 100 x 1,0 | 2,5 | 68960-7 | 16,12/m | 68968-3 | 14,38/m |
| | | 546 | 100 x 2,0 | 2,5 | 68962-1 | 30,46/m | 68970-6 | 28,74/m |
| | | 547 | 100 x 3,0 | 2,5* | 68964-5 | 44,88/m | 68972-0 | 43,12/m |
| | edelstahl-farbig stainless steel coloured | | 100 x 1,0 | 2,5* | 68984-3 | 19,82/m | 68992-8 | 18,10/m |
| | | | 100 x 2,0 | 2,5* | 68986-7 | 34,20/m | 68994-2 | 32,46/m |
| | | | 100 x 3,0 | 2,5* | 68988-1 | 48,56/m | 68996-6 | 46,84/m |

* inklusive 40 mm
 Klemmstelle an einer
 Seite vom Eloxieren/
 including 40 mm
 clamping point on one
 side by anodizing

3,0 m-Ware ist nur per Spedition lieferbar (gesonderte Transportkosten)

3,0 m profiles are only available per forwarding agency (separate transport costs)

4. ÜBERGANGSPROFILE/ 4. CONNECTING PROFILES

Andere Abmaße auf Anfrage/ other dimensions on demand

| Flachprofile/ Flachswellen aus Edelstahl , matt gebürstet | | | | | | | |
|--|-----------|---|-----------|-------------|---|-----------|-------------|
| flat thresholds out of stainless steel matt brushed | | | | | | | |
| Breite/ width A (mm) | L / l (m) | B = 1,0 mm Materialstärke/ thickness | | | B = 1,5 mm Materialstärke/ thickness | | |
| | | Koffernr. case no. | Art./ref. | €/Stk./pcs. | Koffernr. case no. | Art./ref. | €/Stk./pcs. |

413 Flachprofil/ Flachschwelle 1,0 / 1,5 / 2,0 / 3,0 / 5,0 mm, **Edelstahl matt**

flat threshold
1,0/ 1,5/ 2,0/ 3,0/ 5,0 mm,
stainless steel matt

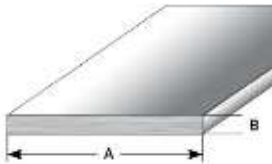

Bitte Befestigungstyp angeben:

- 01 mittig gebohrt
- 02 seitlich gebohrt
- 03 wechselseitig seitlich
- 04 ungebohrt

05 selbstklebend

Please specify fixing:

- 01 drilled centrally
- 02 drilled laterally
- 03 alternating sides drilled
- 04 undrilled
- 05 self adhesive

| | | | | | | | |
|----------------------|------|-----|---------|-------|-----|---------|-------|
| NEU! 30 mm | 1,00 | 548 | 72648-7 | 9,06 | 549 | 72660-9 | 13,10 |
| | 2,50 | | 72650-0 | 22,66 | | 72662-3 | 32,72 |
| NEU! 35 mm | 1,00 | 550 | 72652-4 | 10,58 | 551 | 72664-7 | 15,06 |
| | 2,50 | | 72654-8 | 26,44 | | 72666-1 | 27,48 |
| 40 mm | 1,00 | 442 | 68350-6 | 11,64 | 443 | 68362-9 | 17,50 |
| | 2,50 | | 68352-0 | 29,10 | | 68364-3 | 43,68 |
| NEU! 45 mm | 1,00 | 552 | 72656-2 | 13,60 | 553 | 72668-5 | 18,56 |
| | 2,50 | | 72658-6 | 33,98 | | 72670-8 | 46,42 |
| 50 mm | 1,00 | 285 | 67420-7 | 15,60 | 288 | 67442-9 | 19,64 |
| | 2,50 | | 61892-8 | 39,26 | | 61906-2 | 49,10 |
| 60 mm | 1,00 | 286 | 67422-1 | 19,38 | 289 | 67444-3 | 23,56 |
| | 2,50 | | 61894-2 | 48,46 | | 61908-6 | 58,92 |
| 70 mm | 1,00 | 414 | 67424-5 | 21,66 | 416 | 67446-7 | 27,48 |
| | 2,50 | | 67426-9 | 54,06 | | 67448-1 | 68,74 |
| 80 mm | 1,00 | 287 | 67428-3 | 24,36 | 290 | 67450-4 | 31,40 |
| | 2,50 | | 61896-6 | 60,94 | | 61910-9 | 78,52 |
| 100 mm | 1,00 | 415 | 67430-6 | 30,90 | 291 | 67452-8 | 39,28 |
| | 2,50 | | 67432-0 | 77,30 | | 61912-3 | 98,16 |

| Breite/ width A (mm) | L / l (m) | B = 2,0 mm Materialstärke/ thickness | | | B = 3,0 mm Materialstärke/ thickness | | |
|-------------------------|-----------|---|-----------|-------------|---|-----------|-------------|
| | | Koffernr. case no. | Art./ref. | €/Stk./pcs. | Koffernr. case no. | Art./ref. | €/Stk./pcs. |
| NEU! 30 mm | 1,00 | 554 | 72672-2 | 17,38 | 555 | 72684-5 | 24,54 |
| | 2,50 | | 72674-6 | 43,42 | | 72686-9 | 61,36 |
| NEU! 35 mm | 1,00 | 556 | 72676-0 | 20,14 | 557 | 72688-3 | 28,64 |
| | 2,50 | | 72678-4 | 50,66 | | 72690-6 | 71,60 |
| 40 mm | 1,00 | 444 | 68374-2 | 23,28 | 445 | 68386-5 | 34,94 |
| | 2,50 | | 68376-6 | 58,26 | | 68388-9 | 87,36 |
| NEU! 45 mm | 1,00 | 558 | 72680-7 | 24,74 | 559 | 72692-0 | 36,82 |
| | 2,50 | | 72682-1 | 61,84 | | 72694-4 | 92,06 |
| 50 mm | 1,00 | 417 | 67464-1 | 26,18 | 422 | 67496-2 | 39,28 |
| | 2,50 | | 67466-5 | 65,46 | | 67498-6 | 98,16 |
| 60 mm | 1,00 | 418 | 67468-9 | 31,40 | 423 | 67500-6 | 47,12 |
| | 2,50 | | 67470-2 | 78,52 | | 67502-0 | 117,80 |
| 70 mm | 1,00 | 419 | 67472-6 | 36,66 | 424 | 67504-4 | 54,98 |
| | 2,50 | | 67474-0 | 91,62 | | 67506-8 | 137,44 |
| 80 mm | 1,00 | 420 | 67476-4 | 41,90 | 425 | 67508-2 | 62,84 |
| | 2,50 | | 67478-8 | 104,74 | | 67510-5 | 157,08 |
| 100 mm | 1,00 | 421 | 67480-1 | 52,36 | 426 | 67512-9 | 78,52 |
| | 2,50 | | 67482-5 | 130,90 | | 67514-3 | 196,36 |

**Bohrungen bis 2 mm Stärke für 3,5 mm Schrauben;
Bohrungen bei 3 - 5 mm Stärke für 4 mm Schrauben**
holes up to 2 mm thickness for 3.5 mm screws;
drilling at 3 - 5 mm for 4 mm screws

Edelstahlschrauben siehe Abschnitt 12/ stainless steel screws see section 12

4. ÜBERGANGSPROFILE/ 4. CONNECTING PROFILES

Andere Abmaße auf Anfrage/ other dimensions on demand

| Flachprofile/ Flachswellen aus Edelstahl , matt gebürstet | | | | |
|--|-----------|---|-----------|-------------|
| flat threshold out of stainless steel matt brushed | | | | |
| Breite/ width A (mm) | L / l (m) | B = 5,0 mm Materialstärke/ thickness | | |
| | | Koffernr. case no. | Art./ref. | €/Stk./pcs. |

413 Flachprofil/ Flachschwelle 5,0 mm, Edelstahl matt

flat threshold 5,0 mm, stainless steel matt

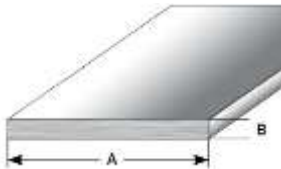

Bohrungen bei 3 - 5 mm Stärke für 4 mm Schrauben
 drilling at 3 - 5 mm for 4 mm screws

| | | | | |
|-------|------|-----|---------|--------|
| 30 mm | 1,00 | 560 | 72596-1 | 49,10 |
| | 2,50 | | 72598-5 | 122,74 |
| 35 mm | 1,00 | 561 | 72600-5 | 57,28 |
| | 2,50 | | 72602-9 | 143,18 |
| 40 mm | 1,00 | 562 | 72604-3 | 65,46 |
| | 2,50 | | 72606-7 | 163,64 |
| 45 mm | 1,00 | 563 | 72608-1 | 73,64 |
| | 2,50 | | 72610-4 | 184,10 |
| 50 mm | 1,00 | 564 | 72612-8 | 81,82 |
| | 2,50 | | 72614-2 | 204,56 |
| 60 mm | 1,00 | 565 | 72616-6 | 98,18 |
| | 2,50 | | 72618-0 | 245,46 |

Bitte Befestigungstyp angeben:

- 01 mittig gebohrt
- 02 seitlich gebohrt
- 03 wechselseitig seitlich
- 04 ungebohrt
- 05 selbstklebend

Please specify fixing:

- 01 drilled centrally
- 02 drilled laterally
- 03 alternating sides drilled
- 04 undrilled
- 05 self adhesive

Andere Abmaße auf Anfrage/ other dimensions on demand

| Verbundschwellen Edelstahl - Aluminium | | | | | |
|---|-----------|---|-------------|---|-------------|
| composite threshold stainless steel - aluminium | | | | | |
| Breite/ width A (mm) | L / l (m) | B = 5,0 mm Materialstärke/ thickness | | B = 8,0 mm Materialstärke/ thickness | |
| | | Art./ref. | €/Stk./pcs. | Art./ref. | €/Stk./pcs. |

Verbundschwelle, ungebohrt/ composite threshold undrilled

Deckprofil Edelstahl matt verklebt mit Grundkonstruktion Aluminium pressblank
 cover profile out of matt stainless steel glued to basic construction aluminium mill finish

| | | | | | | |
|-----|-------|------|---------|--------|---------|--------|
| 566 | 40 mm | 1,00 | 72622-7 | 43,42 | 72626-5 | 53,08 |
| | | 2,50 | 72624-1 | 108,58 | 72628-9 | 132,70 |
| 567 | 50 mm | 1,00 | 72630-2 | 48,74 | 72634-0 | 60,80 |
| | | 2,50 | 72632-6 | 121,86 | 72636-4 | 152,00 |
| 568 | 60 mm | 1,00 | 72638-8 | 56,38 | 72642-5 | 70,84 |
| | | 2,50 | 72640-1 | 140,94 | 72644-9 | 177,14 |



Lieferzeit nach Absprache
 delivery time after consultation

Andere Befestigungstypen (gebohrt, selbstklebend,...), sowie ausgeklinkte Version auf Anfrage erhältlich.
 Other fastening types (drilled, self-adhesive,...), as well as notched version available on request.

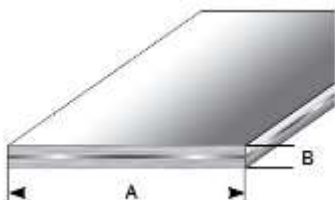

4. ÜBERGANGSPROFILE/ 4. CONNECTING PROFILES

Andere Eloxalfarben siehe
 Abschnitt 6, Lieferzeit 14 Tage/
 other anodized colours see
 section 6, delivery time 14 days

| Profi-Pack à 10 Stück im Bund | | | |
|--------------------------------|-----------|-----------|-------------|
| professional packing à 10 pcs. | | | |
| Farbe/colour | L / l (m) | Art./ref. | €/Stk./pcs. |

| SB-Pack incl. Schr./ Dübel; VE 20 Stk. | |
|---|-------------|
| self-service-pack with screws/ dowels; à 20 pcs. | |
| Art./ref. | €/Stk./pcs. |

09 Abschlussprofil 30 x 4,5 mm, Aluminium eloxiert, gebohrt

adaptation profile 30 x 4,5 mm,
 aluminium anodized,
 drilled

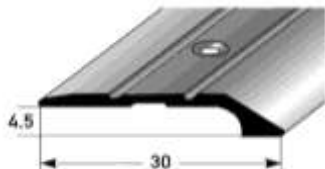

| | | | |
|--------------------------------|-----|---------|-------|
| silberfarbig silver | 0,9 | 08090-9 | 6,46 |
| | 1,0 | 08100-5 | 7,22 |
| | 2,7 | 08110-4 | 19,40 |
| goldfarbig gold | 0,9 | 08190-6 | 6,56 |
| | 1,0 | 08200-2 | 7,34 |
| | 2,7 | 08210-1 | 19,80 |
| bronzef. hell bronze light | 0,9 | 08290-3 | 6,84 |
| | 1,0 | 08300-9 | 7,60 |
| | 2,7 | 08310-8 | 20,50 |
| bronzef. dunkel bronze dark | 0,9 | 08390-0 | 6,84 |
| | 1,0 | 08400-6 | 7,60 |
| | 2,7 | 08410-5 | 20,50 |

| | |
|---------|-------|
| 08091-6 | 7,34 |
| 08101-2 | 8,14 |
| 08111-1 | 22,02 |
| 08191-3 | 7,42 |
| 08201-9 | 8,26 |
| 08211-8 | 22,32 |
| 08291-0 | 8,08 |
| 08301-6 | 8,98 |
| 08311-5 | 24,30 |
| 08391-7 | 7,70 |
| 08401-3 | 8,52 |
| 08411-2 | 23,02 |

09 Abschlussprofil 30 x 4,5 mm, Aluminium eloxiert, selbstklebend

adaptation profile 30 x 4,5 mm,
 aluminium anodized,
 self-adhesive

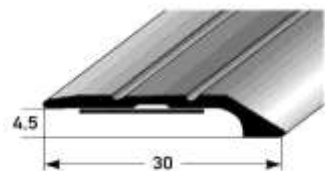

| | | | |
|--------------------------------|-----|---------|-------|
| silberfarbig silver | 0,9 | 08093-0 | 8,46 |
| | 1,0 | 08103-6 | 9,40 |
| | 2,7 | 08113-5 | 25,26 |
| goldfarbig gold | 0,9 | 08193-7 | 8,56 |
| | 1,0 | 08203-3 | 9,50 |
| | 2,7 | 08213-2 | 25,68 |
| bronzef. hell bronze light | 0,9 | 08293-4 | 8,74 |
| | 1,0 | 08303-0 | 9,74 |
| | 2,7 | 08313-9 | 26,30 |
| bronzef. dunkel bronze dark | 0,9 | 08393-1 | 8,74 |
| | 1,0 | 08403-7 | 9,74 |
| | 2,7 | 08413-6 | 26,30 |

| | |
|---------|-------|
| 08092-3 | 8,98 |
| 08102-9 | 9,94 |
| 08112-8 | 26,94 |
| 08192-0 | 9,08 |
| 08202-6 | 10,16 |
| 08212-5 | 27,34 |
| 08292-7 | 9,40 |
| 08302-3 | 10,38 |
| 08312-2 | 28,00 |
| 08392-4 | 9,40 |
| 08402-0 | 10,38 |
| 08412-9 | 28,00 |

349 Anpassungsprofil 40 mm, Höhenausgleich 2 bis 16 mm, Aluminium eloxiert, gebohrt

levelling profile 40 mm,
 height compensation 2-16 mm,
 aluminium anodized,
 drilled



| | | | |
|--------------------------------|-----|---------|-------|
| silberfarbig silver | 1,0 | 66116-0 | 10,34 |
| | 2,7 | 66118-4 | 27,92 |
| goldfarbig gold | 1,0 | 66120-7 | 10,62 |
| | 2,7 | 66122-1 | 28,68 |
| bronzef. hell bronze light | 1,0 | 66124-5 | 11,56 |
| | 2,7 | 66126-9 | 31,22 |
| bronzef. dunkel bronze dark | 1,0 | 66128-3 | 11,56 |
| | 2,7 | 66130-6 | 31,22 |

| | |
|---------|-------|
| 66136-8 | 11,26 |
| 66138-2 | 30,74 |
| 66140-5 | 11,56 |
| 66142-9 | 31,48 |
| 66144-3 | 12,96 |
| 66146-7 | 35,44 |
| 66148-1 | 12,50 |
| 66150-4 | 34,00 |

349 Anpassungsprofil 40 mm, Höhenausgleich 2 bis 16 mm, Aluminium elox., selbstklebend

levelling profile 40 mm,
 height compensation 2-16 mm,
 aluminium anodized,
 self-adhesive



| | | | |
|--------------------------------|-----|---------|-------|
| silberfarbig silver | 1,0 | 66158-0 | 12,48 |
| | 2,7 | 66160-3 | 33,68 |
| goldfarbig gold | 1,0 | 66162-7 | 12,76 |
| | 2,7 | 66164-1 | 34,40 |
| bronzef. hell bronze light | 1,0 | 66166-5 | 13,70 |
| | 2,7 | 66168-9 | 36,96 |
| bronzef. dunkel bronze dark | 1,0 | 66170-2 | 13,70 |
| | 2,7 | 66172-6 | 36,96 |

| | |
|---------|-------|
| 66178-8 | 13,04 |
| 66180-1 | 35,38 |
| 66182-5 | 13,32 |
| 66184-9 | 36,10 |
| 66186-3 | 14,26 |
| 66188-7 | 38,68 |
| 66190-0 | 14,26 |
| 66192-4 | 38,68 |

4. ÜBERGANGSPROFILE/ 4. CONNECTING PROFILES

Andere Eloxalfarben siehe
Abschnitt 6, Lieferzeit 14 Tage/
other anodized colours see section 6,
delivery time 14 days

| Profi-Pack à 10 Stück im Bund | | | |
|--------------------------------|-----------|-----------|-------------|
| professional packing à 10 pcs. | | | |
| Farbe/colour | L / l (m) | Art./ref. | €/Stk./pcs. |

| SB-Pack incl. Schr./ Dübel; VE 20 Stk. | |
|---|-------------|
| self-service-pack with screws/ dowels; à 20 pcs. | |
| Art./ref. | €/Stk./pcs. |

132 Abschlussprofil für Laminat, 34 x 8,5 mm, Aluminium eloxiert, gebohrt

adaptation profile for laminate,
34 x 8,5 mm, aluminium
anodized, drilled

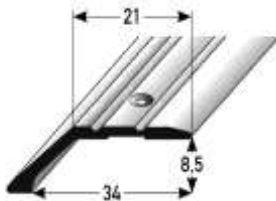

| | | | | | |
|--------------------------------|-----|---------|-------|---------|-------|
| silberfarbig silver | 1,0 | 41580-0 | 9,44 | 41581-7 | 10,40 |
| | 2,7 | 41590-9 | 25,36 | | |
| goldfarbig gold | 1,0 | 41600-5 | 9,68 | 41601-2 | 10,64 |
| | 2,7 | 41610-4 | 26,16 | | |
| bronzef. hell bronze light | 1,0 | 41620-3 | 10,54 | 41621-0 | 11,96 |
| | 2,7 | 41630-2 | 28,38 | | |
| bronzef. dunkel bronze dark | 1,0 | 41640-1 | 10,54 | 41641-8 | 11,50 |
| | 2,7 | 41650-0 | 28,38 | | |
| gold hell gold light | 1,0 | 62245-1 | 9,68 | 62255-0 | 10,64 |
| | 2,7 | 62250-5 | 26,16 | | |

132 Abschlussprofil für Laminat, 34 x 8,5 mm, Aluminium eloxiert, selbstklebend

adaptation profile for laminate,
34 x 8,5 mm, aluminium
anodized, self-adhesive

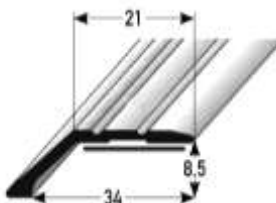

| | | | | | |
|--------------------------------|-----|---------|-------|---------|-------|
| silberfarbig silver | 1,0 | 47922-2 | 11,14 | 47926-0 | 12,10 |
| | 2,7 | 47924-6 | 30,12 | | |
| goldfarbig gold | 1,0 | 47930-7 | 11,44 | 47934-5 | 12,24 |
| | 2,7 | 47932-1 | 30,76 | | |
| bronzef. hell bronze light | 1,0 | 47938-3 | 12,24 | 47942-0 | 12,96 |
| | 2,7 | 47940-6 | 33,02 | | |
| bronzef. dunkel bronze dark | 1,0 | 47946-8 | 12,24 | 47950-5 | 12,96 |
| | 2,7 | 47948-2 | 33,02 | | |
| gold hell gold light | 1,0 | 48100-3 | 11,44 | 48104-1 | 12,12 |
| | 2,7 | 48102-7 | 30,76 | | |

133 Abschlussprofil für Parkett, 47 x 15,5 mm, Aluminium eloxiert, gebohrt

adaptation profile for wooden
floor, 47 x 15,5 mm, aluminium
anodized, drilled

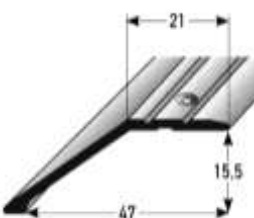

| | | | | | |
|--------------------------------|-----|---------|-------|---------|-------|
| silberfarbig silver | 1,0 | 41660-9 | 12,18 | 41661-6 | 13,18 |
| | 2,7 | 41670-8 | 32,86 | | |
| goldfarbig gold | 1,0 | 41680-7 | 12,60 | 41681-4 | 13,58 |
| | 2,7 | 41690-6 | 34,02 | | |
| bronzef. hell bronze light | 1,0 | 41700-2 | 13,72 | 41701-9 | 15,08 |
| | 2,7 | 41710-1 | 37,00 | | |
| bronzef. dunkel bronze dark | 1,0 | 41720-0 | 13,72 | 41721-7 | 14,68 |
| | 2,7 | 41730-9 | 37,00 | | |
| gold hell gold light | 1,0 | 62275-8 | 12,60 | 62285-7 | 13,58 |
| | 2,7 | 62280-2 | 34,02 | | |

133 Abschlussprofil für Parkett, 47 x 15,5 mm, Aluminium eloxiert, selbstklebend

adaptation profile for wooden
floor, 47 x 15,5 mm, aluminium
anodized, self-adhesive

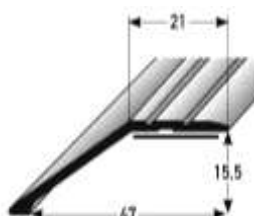

| | | | | | |
|--------------------------------|-----|---------|-------|---------|-------|
| silberfarbig silver | 1,0 | 47956-7 | 13,88 | 47960-4 | 14,60 |
| | 2,7 | 47958-1 | 37,50 | | |
| goldfarbig gold | 1,0 | 47964-2 | 14,30 | 47968-0 | 15,04 |
| | 2,7 | 47966-6 | 38,68 | | |
| bronzef. hell bronze light | 1,0 | 47972-7 | 15,44 | 47976-5 | 17,14 |
| | 2,7 | 47974-1 | 41,66 | | |
| bronzef. dunkel bronze dark | 1,0 | 47980-2 | 15,44 | 47984-0 | 17,14 |
| | 2,7 | 47982-6 | 41,66 | | |
| gold hell gold light | 1,0 | 48110-2 | 14,30 | 48114-0 | 15,04 |
| | 2,7 | 48112-6 | 38,68 | | |

4. ÜBERGANGSPROFILE/ 4. CONNECTING PROFILES

Andere Eloxalfarben siehe
Abschnitt 6, Lieferzeit 14 Tage/
other anodized colours see section 6,
delivery time 14 days

137 **Sockelprofil**
8 x 18,4 mm, für
Wandabschlüsse,
Aluminium eloxiert,
selbstklebend

plinth profile 8 x 18,4 mm,
as wall edging, aluminium
anodized, self-adhesive

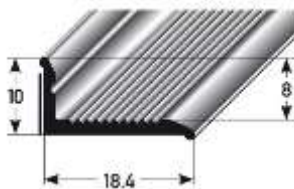

SB-Pack à 20 Stück

self-service-pack à 20 pcs.

| Farbe/colour | L / l (m) | Art./ref. | €/Stk./pcs. |
|---|-----------|-----------|-------------|
| silberfarbig silver | 0,9 | 41741-5 | 8,46 |
| | 2,7 | 41751-4 | 25,32 |
| goldfarbig gold | 0,9 | 41761-3 | 8,60 |
| | 2,7 | 41771-2 | 25,78 |
| bronzefarbig hell bronze light | 0,9 | 41781-1 | 10,72 |
| | 2,7 | 41791-0 | 32,20 |
| edelstahlfarb./ AL-INOX stainless steel coloured | 0,9 | 41800-9 | 9,02 |
| | 2,7 | 41810-8 | 27,10 |
| gold hell gold light | 0,9 | 62080-8 | 8,60 |
| | 2,7 | 62085-3 | 25,78 |
| weiß pulverbeschichtet white powder coated | 0,9 | 62090-7 | 9,68 |
| | 2,7 | 62095-2 | 29,04 |
| Buche beech | 0,9 | 41821-4 | 15,28 |
| | 2,7 | 41831-3 | 45,88 |
| Eiche oak | 0,9 | 41841-2 | 15,28 |
| | 2,7 | 41851-1 | 45,88 |
| Ahorn maple | 0,9 | 41861-0 | 15,28 |
| | 2,7 | 41871-9 | 45,88 |
| Kirschbaum cherry wood | 0,9 | 41844-3 | 15,28 |
| | 2,7 | 41854-2 | 45,88 |
| Eiche rustikal rustic oak | 0,9 | 41864-1 | 15,28 |
| | 2,7 | 41874-0 | 45,88 |

Holzdekorfolie/ wood decor

Profi-Pack à 10 Stück im Bund

professional packing à 10 pcs.

| Farbe/colour | L / l (m) | Art./ref. | €/Stk./pcs. |
|--------------|-----------|-----------|-------------|
|--------------|-----------|-----------|-------------|

SB-Pack incl. Schr./ Dübel; VE 20 Stk.

self-service-pack with screws/
dowels; à 20 pcs.

| Art./ref. | €/Stk./pcs. |
|-----------|-------------|
|-----------|-------------|

506 **Abschlussprofil 28 x 3 mm, Aluminium elox., mittig gebohrt**

adaptation profile 28 x 3 mm,
aluminium anodized, drilled

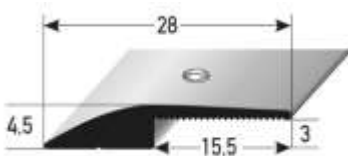

seitlich gebohrt auf Anfrage
laterally drilled on request

| | | | |
|---|-----|---------|-------|
| silberfarbig silver | 1,0 | 71590-0 | 7,16 |
| | 2,7 | 71592-4 | 19,30 |
| goldfarbig gold | 1,0 | 71594-8 | 7,38 |
| | 2,7 | 71596-2 | 19,96 |
| bronzef. hell bronze light | 1,0 | 71598-6 | 7,94 |
| | 2,7 | 71600-6 | 21,40 |
| bronzef. dunkel bronze dark | 1,0 | 71602-0 | 8,18 |
| | 2,7 | 71604-4 | 22,12 |
| edelstahlfarbig Feinschliff fine-honed stainless steel coloured | 1,0 | 71606-8 | 8,18 |
| | 2,7 | 71608-2 | 22,12 |

| | |
|---------|-------|
| 71610-5 | 8,08 |
| 71612-9 | 22,08 |
| 71614-3 | 8,30 |
| 71616-7 | 22,70 |
| 71618-1 | 9,22 |
| 71620-4 | 25,24 |
| 71622-8 | 9,10 |
| 71624-2 | 24,88 |
| 71626-6 | 9,10 |
| 71628-0 | 24,88 |

506 **Abschlussprofil 28 x 3 mm, Aluminium elox., ungebohrt**

adaptation profile 28 x 3 mm,
aluminium anodized, undrilled

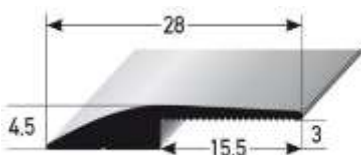

| | | | |
|---|-----|---------|-------|
| silberfarbig silver | 1,0 | 71712-6 | 6,56 |
| | 2,7 | 71714-0 | 17,72 |
| goldfarbig gold | 1,0 | 71716-4 | 6,82 |
| | 2,7 | 71718-8 | 18,42 |
| bronzef. hell bronze light | 1,0 | 71720-1 | 7,62 |
| | 2,7 | 71722-5 | 20,58 |
| bronzef. dunkel bronze dark | 1,0 | 71724-9 | 7,62 |
| | 2,7 | 71726-3 | 20,58 |
| edelstahlfarbig Feinschliff fine-honed stainless steel coloured | 1,0 | 71728-7 | 7,62 |
| | 2,7 | 71730-0 | 20,58 |

| | |
|---------|-------|
| 71732-4 | 7,28 |
| 71734-8 | 19,64 |
| 71736-2 | 7,54 |
| 71738-6 | 20,32 |
| 71740-9 | 8,32 |
| 71742-3 | 22,50 |
| 71744-7 | 8,32 |
| 71746-1 | 22,50 |
| 71748-5 | 8,32 |
| 71750-8 | 22,50 |

5. EINSCHUB- & ANSTOßPROFILE AUS ALUMINIUM

5. INSERT PROFILES OUT OF ALUMINIUM

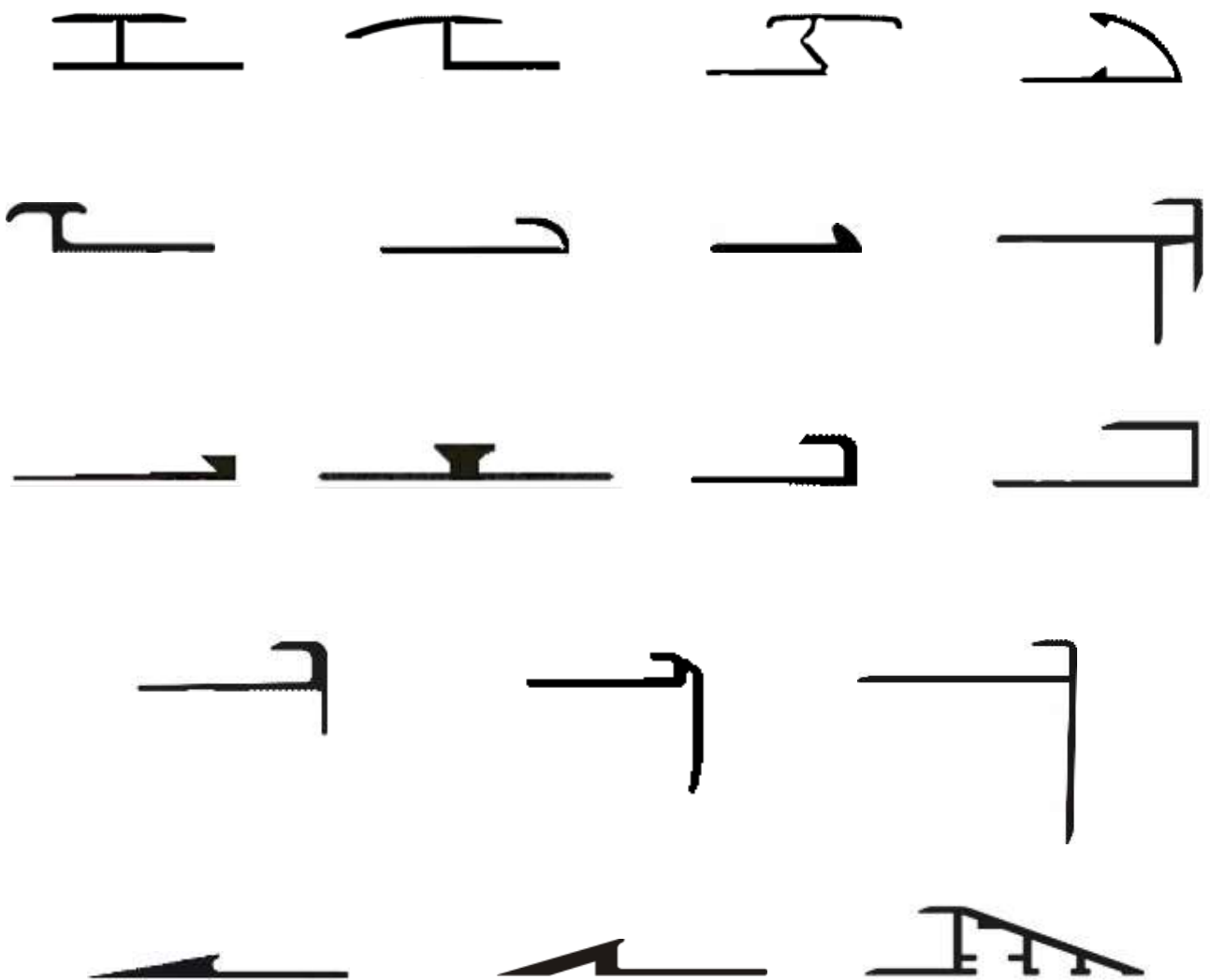

5. EINSCHUB- & ANSTOßPROFILE/ 5. INSERT PROFILES

Andere Eloxalfarben siehe Abschnitt 6, Lieferzeit 14 Tage!
other anodized colours see section 6, delivery time 14 days

| Profi-Pack à 10 Stück im Bund | | | |
|--------------------------------|-----------|-----------|-------------|
| professional packing à 10 pcs. | | | |
| Farbe/colour | L / l (m) | Art./ref. | €/Stk./pcs. |

| SB-Pack incl. Schr./ Dübel; VE 20 Stk. | |
|---|-------------|
| self-service-pack with screws/dowels; à 20 pcs. | |
| Art./ref. | €/Stk./pcs. |

348 Doppeleinschubprofil 14 x 3 mm, Aluminium eloxiert, gebohrt

double insert profile 14 x 3 mm, aluminium anodized, drilled

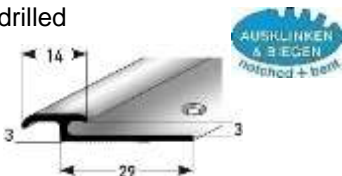

| | | | |
|--------------------------------|-----|---------|-------|
| silberfarbig silver | 1,0 | 65948-8 | 8,28 |
| | 2,7 | 65950-1 | 22,34 |
| goldfarbig gold | 1,0 | 65952-5 | 8,60 |
| | 2,7 | 65954-9 | 23,22 |
| bronzef. hell bronze light | 1,0 | 65956-3 | 9,62 |
| | 2,7 | 65958-7 | 26,02 |
| bronzef. dunkel bronze dark | 1,0 | 65960-0 | 9,62 |
| | 2,7 | 65962-4 | 26,02 |

| | |
|---------|-------|
| 65968-6 | 9,18 |
| 65970-9 | 25,10 |
| 65972-3 | 9,50 |
| 65974-7 | 25,94 |
| 65976-1 | 10,56 |
| 65978-5 | 28,74 |
| 65980-8 | 10,56 |
| 65982-2 | 28,74 |

347 Doppeleinschubprofil 14 x 5 mm, Aluminium eloxiert, gebohrt

double insert profile 14 x 5 mm, aluminium anodized, drilled



| | | | |
|--------------------------------|-----|---------|-------|
| silberfarbig silver | 1,0 | 65990-7 | 8,54 |
| | 2,7 | 65992-1 | 23,08 |
| goldfarbig gold | 1,0 | 65994-5 | 8,88 |
| | 2,7 | 65996-9 | 23,92 |
| bronzef. hell bronze light | 1,0 | 65998-3 | 9,96 |
| | 2,7 | 66000-2 | 26,86 |
| bronzef. dunkel bronze dark | 1,0 | 66002-6 | 9,96 |
| | 2,7 | 66004-0 | 26,86 |

| | |
|---------|-------|
| 66010-1 | 9,46 |
| 66012-5 | 25,80 |
| 66014-9 | 9,76 |
| 66016-3 | 26,64 |
| 66018-7 | 10,82 |
| 66020-0 | 29,60 |
| 66022-4 | 10,82 |
| 66024-8 | 29,60 |

346 Doppeleinschubprofil 14 x 7 mm, Aluminium eloxiert, gebohrt

double insert profile 14 x 7 mm, aluminium anodized, drilled

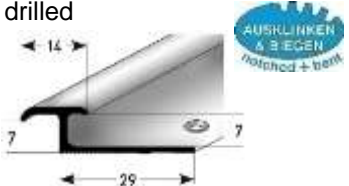

| | | | |
|--------------------------------|-----|---------|-------|
| silberfarbig silver | 1,0 | 66074-3 | 8,84 |
| | 2,7 | 66076-7 | 23,84 |
| goldfarbig gold | 1,0 | 66078-1 | 9,16 |
| | 2,7 | 66080-4 | 24,76 |
| bronzef. hell bronze light | 1,0 | 66082-8 | 10,30 |
| | 2,7 | 66084-2 | 27,86 |
| bronzef. dunkel bronze dark | 1,0 | 66086-6 | 10,30 |
| | 2,7 | 66088-0 | 27,86 |

| | |
|---------|-------|
| 66094-1 | 9,74 |
| 66096-5 | 26,58 |
| 66098-9 | 10,08 |
| 66100-9 | 27,48 |
| 66102-3 | 11,20 |
| 66104-7 | 30,58 |
| 66106-1 | 11,20 |
| 66108-5 | 30,58 |



| Befestigungsschenkel ausklinken attachment flanges notched | |
|---|------|
| Art./ref. | €/m |
| 22240-8 | 6,76 |
| Befestigungsschenkel ausklinken und biegen attachment flanges notched and bent | |
| auf Anfrage on request | |

| Art./ref. | €/m |
|---------------------------|------|
| 22240-8 | 6,76 |
| auf Anfrage on request | |

130 Lammat-Übergang einteilig 27 x 8,3 x 38 mm, Aluminium eloxiert, gebohrt

laminate edge profile 27 x 8,3 x 38 mm, one-piece, aluminium anodized, drilled

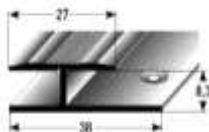

| | | | |
|--------------------------------|-----|---------|-------|
| silberfarbig silver | 1,0 | 41500-8 | 13,62 |
| | 2,7 | 41510-7 | 36,80 |
| goldfarbig gold | 1,0 | 41520-6 | 14,22 |
| | 2,7 | 41530-5 | 38,40 |
| bronzef. hell bronze light | 1,0 | 41540-4 | 15,54 |
| | 2,7 | 41550-3 | 42,02 |
| bronzef. dunkel bronze dark | 1,0 | 41560-2 | 15,54 |
| | 2,7 | 41570-1 | 42,02 |

| | |
|---------|-------|
| 41501-5 | 14,64 |
| 41511-4 | 39,42 |
| 41521-3 | 15,16 |
| 41531-2 | 41,04 |
| 41541-1 | 16,56 |
| 41551-0 | 44,62 |
| 41561-9 | 16,56 |
| 41571-8 | 44,62 |

131 Lammat-Höhenausgleich einteilig 33 x 8,3 x 45 mm, Aluminium eloxiert, gebohrt

laminate height levelling 33 x 8,3 x 45 mm, one-piece, aluminium anodized, drilled

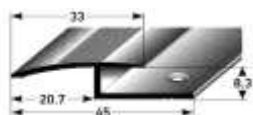

| | | | |
|--------------------------------|-----|---------|-------|
| silberfarbig silver | 1,0 | 41420-9 | 12,90 |
| | 2,7 | 41430-8 | 34,78 |
| goldfarbig gold | 1,0 | 41440-7 | 13,40 |
| | 2,7 | 41450-6 | 36,24 |
| bronzef. hell bronze light | 1,0 | 41460-5 | 14,68 |
| | 2,7 | 41470-4 | 39,64 |
| bronzef. dunkel bronze dark | 1,0 | 41480-3 | 14,68 |
| | 2,7 | 41490-2 | 39,64 |

| | |
|---------|-------|
| 41421-6 | 13,88 |
| 41431-5 | 37,42 |
| 41441-4 | 14,36 |
| 41451-3 | 38,86 |
| 41461-2 | 15,64 |
| 41471-1 | 42,30 |
| 41481-0 | 15,64 |
| 41491-9 | 42,30 |

5. EINSCHUB- & ANSTOßPROFILE/ 5. INSERT PROFILES

Andere Eloxalfarben siehe
Abschnitt 6, Lieferzeit 14 Tage/
other anodized colours see section 6,
delivery time 14 days

| Profi-Pack à 10 Stück im Bund | | | |
|--------------------------------|-----------|-----------|-------------|
| professional packing à 10 pcs. | | | |
| Farbe/colour | L / l (m) | Art./ref. | €/Stk./pcs. |

| SB-Pack incl. Schr./ Dübel; VE 20 Stk. | |
|---|-------------|
| self-service-pack with screws/ dowels; à 20 pcs. | |
| Art./ref. | €/Stk./pcs. |

20 Doppelklemmprofil, Aluminium eloxiert, gebohrt

double jam profile, aluminium
anodized, drilled

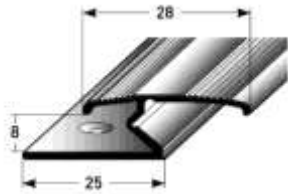

| | | | |
|--------------------------------|-----|---------|-------|
| silberfarbig silver | 0,9 | 25090-6 | 8,50 |
| | 1,0 | 25100-2 | 9,46 |
| | 2,7 | 25110-1 | 25,46 |
| goldfarbig gold | 0,9 | 25190-3 | 8,66 |
| | 1,0 | 25200-9 | 9,62 |
| | 2,7 | 25210-8 | 26,02 |
| bronzef. hell bronze light | 0,9 | 25290-0 | 10,16 |
| | 1,0 | 25300-6 | 11,26 |
| | 2,7 | 25310-5 | 30,36 |
| bronzef. dunkel bronze dark | 0,9 | 25390-7 | 10,16 |
| | 1,0 | 25400-3 | 11,26 |
| | 2,7 | 25410-2 | 30,36 |

| | |
|---------|-------|
| 25091-3 | 9,40 |
| 25101-9 | 10,40 |
| 25111-8 | 28,10 |
| 25191-0 | 9,54 |
| 25201-6 | 10,58 |
| 25211-5 | 28,64 |
| 25291-7 | 11,00 |
| 25301-3 | 12,18 |
| 25311-2 | 32,88 |
| 25391-4 | 11,00 |
| 25401-0 | 12,18 |
| 25411-9 | 32,88 |

auf Anfrage auch selbstklebend erhältlich/ self-adhesive version available on request

19 Einfachklemmprofil, Aluminium eloxiert, gebohrt

single jam profile, aluminium
anodized, drilled

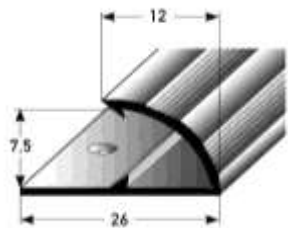

| | | | |
|--------------------------------|-----|---------|-------|
| silberfarbig silver | 0,9 | 24090-7 | 5,72 |
| | 1,0 | 24100-3 | 6,38 |
| | 2,7 | 24110-2 | 17,12 |
| goldfarbig gold | 0,9 | 24190-4 | 5,86 |
| | 1,0 | 24200-0 | 6,48 |
| | 2,7 | 24210-9 | 17,52 |
| bronzef. hell bronze light | 0,9 | 24290-1 | 6,52 |
| | 1,0 | 24300-7 | 7,28 |
| | 2,7 | 24310-6 | 19,60 |
| bronzef. dunkel bronze dark | 0,9 | 24390-8 | 6,52 |
| | 1,0 | 24400-4 | 7,28 |
| | 2,7 | 24410-3 | 19,60 |

| | |
|---------|-------|
| 24091-4 | 6,56 |
| 24101-0 | 7,30 |
| 24111-9 | 19,70 |
| 24191-1 | 6,72 |
| 24201-7 | 7,42 |
| 24211-6 | 20,08 |
| 24291-8 | 7,38 |
| 24301-4 | 8,18 |
| 24311-3 | 22,14 |
| 24391-5 | 7,38 |
| 24401-1 | 8,18 |
| 24411-0 | 22,14 |

auf Anfrage auch selbstklebend erhältlich/ self-adhesive version available on request

23 Miniklemmprofil, Aluminium eloxiert, ungebohrt

mini jam profile,
aluminium anodized,
undrilled

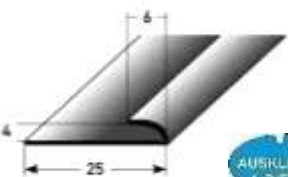

| | | | |
|--------------------------------|-----|---------|-------|
| silberfarbig silver | 1,0 | 36150-3 | 5,22 |
| | 2,7 | 36110-7 | 14,16 |
| goldfarbig gold | 1,0 | 36160-2 | 5,76 |
| | 2,7 | 36120-6 | 15,54 |
| bronzef. hell bronze light | 1,0 | 36170-1 | 7,04 |
| | 2,7 | 36130-5 | 19,14 |
| bronzef. dunkel bronze dark | 1,0 | 36180-0 | 7,04 |
| | 2,7 | 36140-4 | 19,14 |

| | |
|---------|-------|
| 36151-0 | 6,16 |
| 36111-4 | 16,76 |
| 36161-9 | 6,76 |
| 36121-3 | 18,12 |
| 36171-8 | 8,04 |
| 36131-2 | 21,70 |
| 36181-7 | 8,04 |
| 36141-1 | 21,70 |

auf Anfrage auch selbstklebend erhältlich/ self-adhesive version available on request



| |
|---|
| Befestigungsschenkel ausklinken attachment flanges notched |
| Befestigungsschenkel ausklinken und biegen attachment flanges notched and bent |

| | |
|---------------------------|------|
| Art./ref. | €/m |
| 22240-8 | 6,76 |
| auf Anfrage on request | |

5. EINSCHUB- & ANSTOßPROFILE/ 5. INSERT PROFILES

Andere Eloxalfarben siehe
Abschnitt 6, Lieferzeit 14 Tage/
other anodized colours see section 6,
delivery time 14 days

| Profi-Pack à 10 Stück im Bund | | | |
|--------------------------------|-----------|-----------|-------------|
| professional packing à 10 pcs. | | | |
| Farbe/colour | L / l (m) | Art./ref. | €/Stk./pcs. |

| SB-Pack incl. Schr / Dübel; VE 20 Stk. | |
|---|-------------|
| self-service-pack with screws/ dowels; à 20 pcs. | |
| Art./ref. | €/Stk./pcs. |

269 Einfassschiene 2 mm, Aluminium eloxiert, gebohrt

insert profile 2 mm, aluminium
anodized, drilled



| | | | | | |
|-----------------------------------|-----|---------|-------|---------|-------|
| silberfarbig silver | 2,7 | 46652-9 | 14,32 | 46664-2 | 16,90 |
| goldfarbig gold | | 46654-3 | 14,66 | | |
| bronzefarbig hell bronze light | | 46656-7 | 16,28 | | |
| bronzef. dunkel bronze dark | | 46658-1 | 16,28 | | |

| | |
|---------|-------|
| 46664-2 | 16,90 |
| 46666-6 | 17,20 |
| 46668-0 | 18,86 |
| 46670-3 | 18,86 |

387 Einfassschiene 2,5 mm, Aluminium eloxiert, gebohrt

insert profile 2,5 mm, aluminium
anodized, drilled



| | | | | | |
|-----------------------------------|-----|---------|-------|---------|-------|
| silberfarbig silver | 2,7 | 66748-3 | 15,54 | 66764-3 | 18,12 |
| goldfarbig gold | | 66750-6 | 15,92 | | |
| bronzefarbig hell bronze light | | 66752-0 | 17,56 | | |
| bronzef. dunkel bronze dark | | 66754-4 | 17,56 | | |

| | |
|---------|-------|
| 66764-3 | 18,12 |
| 66766-7 | 18,50 |
| 66768-1 | 20,14 |
| 66770-4 | 20,14 |

22 Einfassschiene 3 mm, Aluminium eloxiert, gebohrt

insert profile 3 mm, aluminium
anodized, drilled

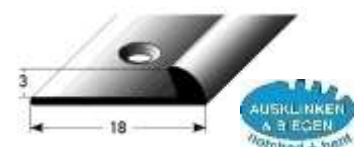

| | | | | | |
|-----------------------------------|-----|---------|-------|---------|-------|
| silberfarbig silver | 2,7 | 46674-1 | 15,84 | 46684-0 | 18,38 |
| goldfarbig gold | | 46676-5 | 16,22 | | |
| bronzefarbig hell bronze light | | 46678-9 | 17,86 | | |
| bronzef. dunkel bronze dark | | 46680-2 | 17,86 | | |

| | |
|---------|-------|
| 46684-0 | 18,38 |
| 46686-4 | 18,76 |
| 46688-8 | 20,38 |
| 46690-1 | 20,38 |

268 Einfassschiene 5 mm, Aluminium eloxiert, gebohrt

insert profile 5 mm, aluminium
anodized, drilled



| | | | | | |
|-----------------------------------|-----|---------|-------|---------|-------|
| silberfarbig silver | 2,7 | 46696-3 | 16,60 | 46708-3 | 19,18 |
| goldfarbig gold | | 46698-7 | 16,86 | | |
| bronzefarbig hell bronze light | | 46700-7 | 18,50 | | |
| bronzef. dunkel bronze dark | | 46702-1 | 18,50 | | |

| | |
|---------|-------|
| 46708-3 | 19,18 |
| 46710-6 | 19,46 |
| 46712-0 | 21,10 |
| 46714-4 | 21,10 |



| | | |
|---|---------------------------|------|
| Befestigungsschenkel ausklinken attachment flanges notched | Art./ref. | €/m |
| Befestigungsschenkel ausklinken und biegen attachment flanges notched and bent | 22240-8 | 6,76 |
| | auf Anfrage on request | |

5. EINSCHUB- & ANSTOßPROFILE/ 5. INSERT PROFILES

Andere Eloxalfarben siehe Abschnitt 6, Lieferzeit 14 Tage/
other anodized colours see section 6, delivery time 14 days

| Profi-Pack à 10 Stück im Bund | | | |
|--------------------------------|-----------|-----------|-------------|
| professional packing à 10 pcs. | | | |
| Farbe/colour | L / l (m) | Art./ref. | €/Stk./pcs. |

| SB-Pack incl. Schr./ Dübel; VE 20 Stk. | |
|--|-------------|
| self-service-pack with screws/ dowels; à 20 pcs. | |
| Art./ref. | €/Stk./pcs. |

27 Anstoßprofil 3 mm, Aluminium eloxiert, gebohrt

edge profile 3 mm, aluminium anodized, drilled

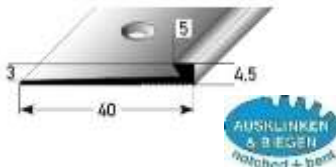

| | | | | | |
|------------------------------------|-----|---------|-------|---------|-------|
| silberfarbig silver | 2,7 | 47904-8 | 22,76 | 47906-2 | 25,62 |
| goldfarbig gold | | 47908-6 | 23,58 | | |
| bronzefarbig hell bronze light | | 47912-3 | 26,20 | | |
| bronzefarbig dunkel bronze dark | | 47916-1 | 26,20 | | |

| | |
|---------|-------|
| 47910-9 | 26,44 |
| 47914-7 | 29,08 |
| 47918-5 | 29,08 |

29 Anstoßprofil 5/3, doppelseitig, Aluminium eloxiert, gebohrt

edge profile 5/3, double, aluminium anodized, drilled



| | | | | | |
|------------------------------------|-----|---------|-------|---------|-------|
| silberfarbig silver | 2,7 | 35870-1 | 23,66 | 35871-8 | 26,26 |
| goldfarbig gold | | 35880-0 | 25,22 | | |
| bronzefarbig hell bronze light | | 35890-9 | 28,58 | | |
| bronzefarbig dunkel bronze dark | | 35900-5 | 28,58 | | |

| | |
|---------|-------|
| 35881-7 | 27,74 |
| 35891-6 | 31,14 |
| 35901-2 | 31,14 |



| | | |
|---|---------------------------|------|
| Befestigungsschenkel ausklinken attachment flanges notched | Art./ref. | €/m |
| Befestigungsschenkel ausklinken und biegen attachment flanges notched and bent | 22240-8 | 6,76 |
| | auf Anfrage on request | |

| | | |
|--|---------------------------|------|
| | Art./ref. | €/m |
| | 22240-8 | 6,76 |
| | auf Anfrage on request | |

28 Anstoßprofil 3/3, doppelseitig, Aluminium eloxiert, gebohrt

edge profile 3/3, double, aluminium anodized, drilled

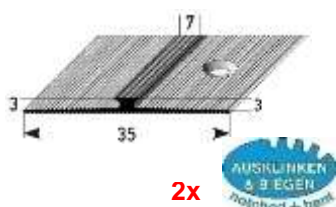

| | | | | | |
|------------------------------------|-----|---------|-------|---------|-------|
| silberfarbig silver | 2,7 | 35950-0 | 21,92 | 35951-7 | 24,48 |
| goldfarbig gold | | 35960-9 | 23,44 | | |
| bronzefarbig hell bronze light | | 35970-8 | 27,04 | | |
| bronzefarbig dunkel bronze dark | | 35980-7 | 27,04 | | |

| | |
|---------|-------|
| 35961-6 | 26,00 |
| 35971-5 | 29,64 |
| 35981-4 | 29,64 |

30 Anstoßprofil 5/5, doppelseitig, Aluminium eloxiert, gebohrt

edge profile 5/5, double, aluminium anodized, drilled

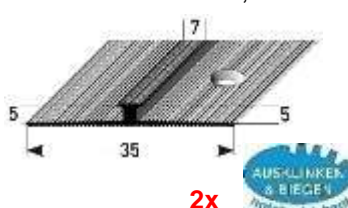

| | | | | | |
|------------------------------------|-----|---------|-------|---------|-------|
| silberfarbig silver | 2,7 | 36030-8 | 23,28 | 36031-5 | 25,84 |
| goldfarbig gold | | 36040-7 | 24,74 | | |
| bronzefarbig hell bronze light | | 36050-6 | 28,28 | | |
| bronzefarbig dunkel bronze dark | | 36060-5 | 28,28 | | |

| | |
|---------|-------|
| 36041-4 | 27,30 |
| 36051-3 | 30,88 |
| 36061-2 | 30,88 |



| | | |
|---|---------------------------|-------|
| 2 x Befestigungsschenkel ausklinken 2 x attachment flanges notched | Art./ref. | €/m |
| Befestigungsschenkel ausklinken und biegen attachment flanges notched and bent | 22260-6 | 13,52 |
| | auf Anfrage on request | |

| | | |
|--|---------------------------|-------|
| | Art./ref. | €/m |
| | 22260-6 | 13,52 |
| | auf Anfrage on request | |

5. EINSCHUB- & ANSTOßPROFILE/ 5. INSERT PROFILES

Andere Eloxalfarben siehe
Abschnitt 6, Lieferzeit

14 Tage/ other anodized colours see
section 6, delivery time 14 days

| Profi-Pack à 10 Stück im Bund | | | |
|--------------------------------|-----------|-----------|-------------|
| professional packing à 10 pcs. | | | |
| Farbe/colour | L / l (m) | Art./ref. | €/Stk./pcs. |

| SB-Pack incl. Schr./ Dübel; VE 20 Stk. | |
|---|-------------|
| self-service-pack with screws/ dowels; à 20 pcs. | |
| Art./ref. | €/Stk./pcs. |

282 Rampenanstoß 2 mm, Aluminium eloxiert, gebohrt

ramp profile 2 mm, aluminium
anodized, drilled



| | | | |
|---|-----|---------|-------|
| silberfarbig silver | 1,0 | 35724-7 | 8,08 |
| | 2,7 | 35726-1 | 21,82 |
| goldfarbig gold | 1,0 | 35728-5 | 8,16 |
| | 2,7 | 35730-8 | 22,12 |
| bronzefarbig hell bronze light | 1,0 | 35732-2 | 8,48 |
| | 2,7 | 35734-6 | 22,84 |
| bronzef. dunkel bronze dark | 1,0 | 35736-0 | 8,48 |
| | 2,7 | 35738-4 | 22,84 |
| edelstahlfarb./ AL-INOX stainless steel coloured | 1,0 | 35710-0 | 8,48 |
| | 2,7 | 35712-4 | 22,84 |

| | |
|---------|-------|
| 35740-7 | 9,02 |
| 35742-1 | 24,46 |
| 35744-5 | 9,10 |
| 35746-9 | 24,70 |
| 35748-3 | 8,98 |
| 35750-6 | 24,24 |
| 35752-0 | 8,98 |
| 35754-4 | 24,24 |
| 35714-8 | 8,98 |
| 35716-2 | 24,24 |

283 Rampenanstoß 3 mm, Aluminium eloxiert, gebohrt

ramp profile 3 mm, aluminium
anodized, drilled



| | | | |
|---|-----|---------|-------|
| silberfarbig silver | 1,0 | 35800-8 | 9,44 |
| | 2,7 | 35802-2 | 25,36 |
| goldfarbig gold | 1,0 | 35804-6 | 9,68 |
| | 2,7 | 35806-0 | 26,16 |
| bronzefarbig hell bronze light | 1,0 | 35808-4 | 10,54 |
| | 2,7 | 35810-7 | 28,38 |
| bronzef. dunkel bronze dark | 1,0 | 35812-1 | 10,54 |
| | 2,7 | 35814-5 | 28,38 |
| edelstahlfarb./ AL-INOX stainless steel coloured | 1,0 | 35720-9 | 10,54 |
| | 2,7 | 35722-3 | 28,38 |

| | |
|---------|-------|
| 35816-9 | 10,40 |
| 35818-3 | 28,08 |
| 35820-6 | 10,64 |
| 35822-0 | 28,80 |
| 35824-4 | 10,96 |
| 35826-8 | 29,60 |
| 35828-2 | 10,96 |
| 35830-5 | 29,60 |
| 35756-8 | 10,96 |
| 35758-2 | 29,60 |

284 Rampenanstoß 5 mm, Aluminium eloxiert, gebohrt

ramp profile 5 mm, aluminium
anodized, drilled

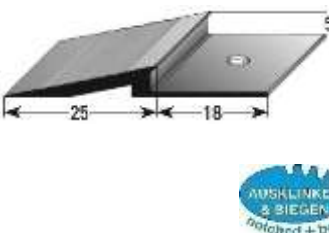

| | | | |
|---|-----|---------|-------|
| silberfarbig silver | 1,0 | 35832-9 | 11,32 |
| | 2,7 | 35834-3 | 30,60 |
| goldfarbig gold | 1,0 | 35836-7 | 11,58 |
| | 2,7 | 35838-1 | 31,30 |
| bronzefarbig hell bronze light | 1,0 | 35840-4 | 13,62 |
| | 2,7 | 35842-8 | 36,80 |
| bronzef. dunkel bronze dark | 1,0 | 35844-2 | 13,62 |
| | 2,7 | 35846-6 | 36,80 |
| edelstahlfarb./ AL-INOX stainless steel coloured | 1,0 | 35762-9 | 13,62 |
| | 2,7 | 35764-3 | 36,80 |

| | |
|---------|-------|
| 35848-0 | 11,70 |
| 35850-3 | 31,70 |
| 35852-7 | 11,94 |
| 35854-1 | 32,36 |
| 35856-5 | 13,88 |
| 35858-9 | 37,60 |
| 35860-2 | 13,88 |
| 35862-6 | 37,60 |
| 35766-7 | 13,88 |
| 35768-1 | 37,60 |

480 Rampenanstoß 8 mm, Aluminium eloxiert, gebohrt

ramp profile 8 mm, aluminium
anodized, drilled

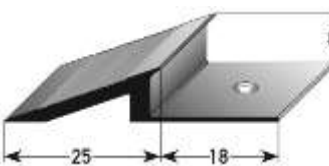

| | | | |
|---|-----|---------|-------|
| silberfarbig silver | 1,0 | 70916-9 | 13,62 |
| | 2,7 | 70918-3 | 36,74 |
| goldfarbig gold | 1,0 | 70920-6 | 13,94 |
| | 2,7 | 70922-0 | 37,56 |
| bronzefarbig hell bronze light | 1,0 | 70924-4 | 16,34 |
| | 2,7 | 70926-8 | 44,14 |
| bronzef. dunkel bronze dark | 1,0 | 70928-2 | 16,34 |
| | 2,7 | 70930-5 | 44,14 |
| edelstahlfarb./ AL-INOX stainless steel coloured | 1,0 | 70932-9 | 16,34 |
| | 2,7 | 70934-3 | 44,14 |

| | |
|---------|-------|
| 70936-7 | 13,88 |
| 70938-1 | 37,54 |
| 70940-4 | 14,16 |
| 70942-8 | 38,34 |
| 70944-2 | 16,46 |
| 70946-6 | 44,60 |
| 70948-0 | 16,46 |
| 70950-3 | 44,60 |
| 70952-7 | 16,46 |
| 70954-1 | 44,60 |



| |
|---|
| Befestigungsschenkel ausklinken attachment flanges notched |
| Befestigungsschenkel ausklinken und biegen attachment flanges notched and bent |

| | |
|---------------------------|------|
| Art./ref. | €/m |
| 22240-8 | 6,76 |
| auf Anfrage on request | |

5. EINSCHUB- & ANSTOßPROFILE/ 5. INSERT PROFILES

Andere Eloxalfarben siehe Abschnitt 6,
 Lieferzeit 14 Tage/ other anodized colours see
 section 6, delivery time 14 days

| Profi-Pack à 10 Stück im Bund | | | |
|--------------------------------|-----------|-----------|-------------|
| professional packing à 10 pcs. | | | |
| Farbe/colour | L / l (m) | Art./ref. | €/Stk./pcs. |

525 Rampeneinschub 10 mm, Aluminium eloxiert, ungebohrt

ramp insertion profile 10 mm, aluminium
 anodized, undrilled

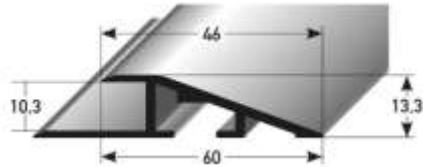

| | | | |
|------------------------|-----|---------|-------|
| silberfarbig silver | 2,7 | 72112-3 | 50,82 |
|------------------------|-----|---------|-------|

526 Rampeneinschub 15 mm, Aluminium eloxiert, ungebohrt

ramp insertion profile 15 mm, aluminium
 anodized, undrilled

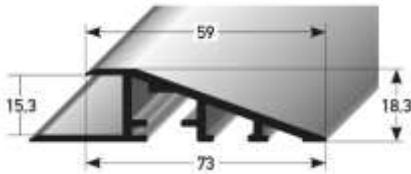

| | | | |
|------------------------|-----|---------|-------|
| silberfarbig silver | 2,7 | 72118-5 | 69,40 |
|------------------------|-----|---------|-------|

527 Rampeneinschub 22 mm, Aluminium eloxiert, ungebohrt

ramp insertion profile 22 mm, aluminium
 anodized, undrilled

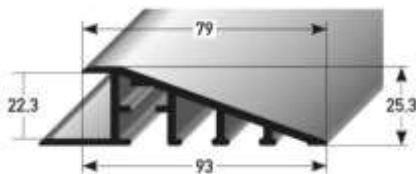

| | | | |
|------------------------|-----|---------|-------|
| silberfarbig silver | 2,7 | 72124-6 | 94,14 |
|------------------------|-----|---------|-------|

528 Längsverbinder für Rampeneinschubprofile, Stahl verzinkt

longitudinal connector for ramp insertion
 profiles, galvanized steel



| | |
|-----------|-------------|
| Art./ref. | €/Stk./pcs. |
| 72130-7 | 7,76 |

529 Eckverbinder für 90°-Ecke, für Rampeneinschubprofile, Stahl verzinkt

corner connector for 90° corner, for ramp
 insertion profiles, galvanized steel

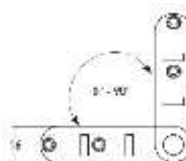

| | |
|---------|-------|
| 72136-9 | 17,58 |
|---------|-------|

536 Eckverbinder flexible Ecke, für Rampeneinschubprofile, Stahl verzinkt

corner connector for flexible corner, for ramp
 insertion profiles, galvanized steel

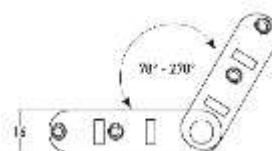

| | |
|---------|-------|
| 72131-4 | 17,58 |
|---------|-------|

5. EINSCHUB- & ANSTOßPROFILE / 5. INSERT PROFILES

Andere Eloxalfarben siehe
Abschnitt 6, Lieferzeit 14 Tage
other anodized colours see section 6,
delivery time 14 days

| Profi-Pack à 10 Stück im Bund | | | |
|--------------------------------|-----------|-----------|-------------|
| professional packing à 10 pcs. | | | |
| Farbe/colour | L / l (m) | Art./ref. | €/Stk./pcs. |

| SB-Pack incl. Schr./ Dübel; VE 20 Stk. | |
|---|-------------|
| self-service-pack with screws/ dowels; à 20 pcs. | |
| Art./ref. | €/Stk./pcs. |

258 Einschubprofil 3 mm, Aluminium eloxiert, gebohrt

insert profile 3 mm,
aluminium anodized, drilled

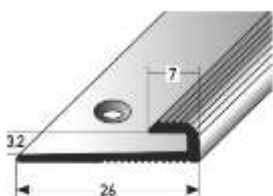

| | | | |
|--------------------------------|-----|---------|-------|
| silberfarbig silver | 0,9 | 46718-2 | 6,26 |
| | 1,0 | 46720-5 | 6,94 |
| | 2,7 | 46722-9 | 18,74 |
| goldfarbig gold | 0,9 | 46732-8 | 6,46 |
| | 1,0 | 46734-2 | 7,20 |
| | 2,7 | 46736-6 | 19,36 |
| bronzef. hell bronze light | 0,9 | 46746-5 | 7,40 |
| | 1,0 | 46748-9 | 8,24 |
| | 2,7 | 46750-2 | 22,22 |
| bronzef. dunkel bronze dark | 0,9 | 46760-1 | 7,40 |
| | 1,0 | 46762-5 | 8,24 |
| | 2,7 | 46764-9 | 22,22 |

| | |
|---------|-------|
| 46724-3 | 7,22 |
| 46726-7 | 7,88 |
| 46728-1 | 21,64 |
| 46738-0 | 7,40 |
| 46740-3 | 8,12 |
| 46742-7 | 22,22 |
| 46752-6 | 8,36 |
| 46754-0 | 9,16 |
| 46756-4 | 25,08 |
| 46766-3 | 8,36 |
| 46768-7 | 9,16 |
| 46770-0 | 25,08 |

530 Einschubprofil 3 mm, Aluminium eloxiert, glatt, gebohrt

insert profile 3 mm, aluminium
anodized, smooth, drilled



| | | | |
|--|-----|---------|-------|
| silberfarbig silver | 0,9 | 72142-0 | 6,68 |
| | 2,7 | 72144-4 | 20,02 |
| edelstahlfarbig stainless steel coloured | 0,9 | 72150-5 | 7,96 |
| | 2,7 | 72152-9 | 23,86 |
| schwarz black | 0,9 | 72578-7 | 7,96 |
| | 2,7 | 72580-0 | 23,86 |

| | |
|---------|-------|
| 72146-8 | 7,62 |
| 72148-2 | 22,84 |
| 72154-3 | 8,90 |
| 72156-7 | 26,68 |
| 72582-4 | 8,90 |
| 72584-8 | 26,68 |

18 Einschubprofil 5 mm, Aluminium eloxiert, gebohrt

insert profile 5 mm,
aluminium anodized, drilled

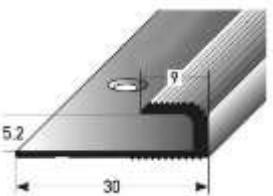

| | | | |
|--------------------------------|-----|---------|-------|
| silberfarbig silver | 0,9 | 26090-5 | 6,92 |
| | 1,0 | 26100-1 | 7,70 |
| | 2,7 | 26130-8 | 20,78 |
| goldfarbig gold | 0,9 | 26190-2 | 7,10 |
| | 1,0 | 26200-8 | 7,90 |
| | 2,7 | 26230-5 | 21,30 |
| bronzef. hell bronze light | 0,9 | 26290-9 | 8,46 |
| | 1,0 | 26300-5 | 9,42 |
| | 2,7 | 26330-2 | 25,32 |
| bronzef. dunkel bronze dark | 0,9 | 26390-6 | 8,46 |
| | 1,0 | 26400-2 | 9,42 |
| | 2,7 | 26430-9 | 25,32 |

| | |
|---------|-------|
| 26091-2 | 7,76 |
| 26101-8 | 8,64 |
| 26131-5 | 23,32 |
| 26191-9 | 7,98 |
| 26201-5 | 8,88 |
| 26231-2 | 23,92 |
| 26291-6 | 9,32 |
| 26301-2 | 10,34 |
| 26331-9 | 27,88 |
| 26391-3 | 9,32 |
| 26401-9 | 10,34 |
| 26431-6 | 27,88 |

531 Einschubprofil 5 mm, Aluminium eloxiert, glatt, gebohrt

insert profile 5 mm, aluminium
anodized, smooth, drilled



| | | | |
|--|-----|---------|-------|
| silberfarbig silver | 0,9 | 72160-4 | 7,34 |
| | 2,7 | 72162-8 | 22,02 |
| edelstahlfarbig stainless steel coloured | 0,9 | 72168-0 | 9,42 |
| | 2,7 | 72170-3 | 28,26 |
| schwarz black | 0,9 | 72586-2 | 9,42 |
| | 2,7 | 72588-6 | 28,26 |

| | |
|---------|-------|
| 72164-2 | 8,28 |
| 72166-6 | 24,86 |
| 72172-7 | 10,36 |
| 72174-1 | 31,10 |
| 72590-9 | 10,36 |
| 72592-3 | 31,10 |



| | |
|---|--|
| Befestigungsschenkel ausklinken attachment flanges notched | |
| Befestigungsschenkel ausklinken und biegen attachment flanges notched and bent | |

| | |
|---------------------------|------|
| Art./ref. | €/m |
| 22240-8 | 6,76 |
| auf Anfrage on request | |

5. EINSCHUB- & ANSTOßPROFILE/ 5. INSERT PROFILES

Andere Eloxalfarben siehe
Abschnitt 6, Lieferzeit 14 Tage
other anodized colours see section 6,
delivery time 14 days

| Profi-Pack à 10 Stück im Bund | | | |
|--------------------------------|-----------|-----------|-------------|
| professional packing à 10 pcs. | | | |
| Farbe/colour | L / l (m) | Art./ref. | €/Stk./pcs. |

| SB-Pack incl. Schr./ Dübel; VE 20 Stk. | |
|---|-------------|
| self-service-pack with screws/ dowels; à 20 pcs. | |
| Art./ref. | €/Stk./pcs. |

2 4 Einschubprofil 6 mm, Aluminium eloxiert, gebohrt

insert profile 6 mm, aluminium
anodized, drilled

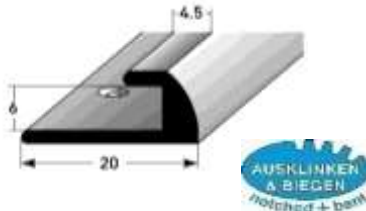

| | | | |
|--------------------------------|-----|---------|-------|
| silberfarbig silver | 2,7 | 47886-7 | 18,68 |
| goldfarbig gold | | 47890-4 | 18,98 |
| bronzef. hell bronze light | | 47894-2 | 21,32 |
| bronzef. dunkel bronze dark | | 47898-0 | 21,32 |

| | |
|---------|-------|
| 47888-1 | 21,54 |
| 47892-8 | 21,82 |
| 47896-6 | 24,18 |
| 47900-0 | 24,18 |

auf Anfrage auch selbstklebend erhältlich/ self-adhesive version available on request

446 Einschubprofil für Laminat 7,5 mm, Aluminium eloxiert, gebohrt

insert profile for laminate 7,5 mm,
aluminium anodized, drilled

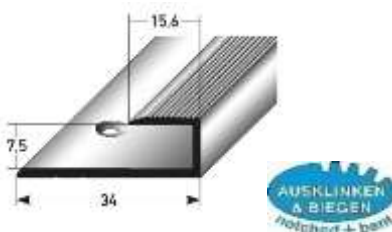

| | | | |
|--------------------------------|-----|---------|-------|
| silberfarbig silver | 1,0 | 48120-1 | 6,36 |
| | 2,7 | 48122-5 | 17,12 |
| goldfarbig gold | 1,0 | 48128-7 | 6,52 |
| | 2,7 | 48130-0 | 17,58 |
| bronzef. hell bronze light | 1,0 | 48144-7 | 7,10 |
| | 2,7 | 48146-1 | 19,12 |
| bronzef. dunkel bronze dark | 1,0 | 48152-2 | 7,10 |
| | 2,7 | 48154-6 | 19,12 |

| | |
|---------|-------|
| 48124-9 | 7,30 |
| 48126-3 | 20,02 |
| 48132-4 | 7,48 |
| 48134-8 | 20,50 |
| 48148-5 | 8,06 |
| 48150-8 | 22,02 |
| 48156-0 | 8,06 |
| 48158-4 | 22,02 |

108 Einschubprofil für Laminat 8,5 mm, Aluminium eloxiert, gebohrt

insert profile for laminate 8,5 mm,
aluminium anodized,
drilled



| | | | |
|--------------------------------|-----|---------|-------|
| silberfarbig silver | 1,0 | 29160-2 | 6,80 |
| | 2,7 | 29165-7 | 18,38 |
| goldfarbig gold | 1,0 | 29170-1 | 6,98 |
| | 2,7 | 29175-6 | 18,98 |
| bronzef. hell bronze light | 1,0 | 29180-0 | 7,60 |
| | 2,7 | 29185-5 | 20,54 |
| bronzef. dunkel bronze dark | 1,0 | 29190-9 | 7,60 |
| | 2,7 | 29195-4 | 20,54 |
| gold hell gold light | 1,0 | 62135-5 | 6,98 |
| | 2,7 | 62140-9 | 18,98 |

| | |
|---------|-------|
| 29166-4 | 7,76 |
| 29167-1 | 20,98 |
| 29176-3 | 7,98 |
| 29177-0 | 21,56 |
| 29186-2 | 8,56 |
| 29187-9 | 23,10 |
| 29196-1 | 8,56 |
| 29197-8 | 23,10 |
| 62145-4 | 7,98 |
| 62155-3 | 21,56 |

Holzdekorfolie/ wood decor

| | | | |
|------------------------------|-----|---------|-------|
| Buche beech | 1,0 | 40580-1 | 10,16 |
| | 2,7 | 40600-6 | 27,36 |
| Eiche oak | 1,0 | 40610-5 | 10,16 |
| | 2,7 | 40630-3 | 27,36 |
| Ahorn maple | 1,0 | 40640-2 | 10,16 |
| | 2,7 | 40660-0 | 27,36 |
| Kirschbaum cherry wood | 1,0 | 43154-1 | 10,16 |
| | 2,7 | 43158-9 | 27,36 |
| Eiche rustikal rustic oak | 1,0 | 43162-6 | 10,16 |
| | 2,7 | 43166-4 | 27,36 |

| | |
|---------|-------|
| 40581-8 | 11,14 |
| 40601-3 | 30,08 |
| 40611-2 | 11,14 |
| 40631-0 | 30,08 |
| 40641-9 | 11,14 |
| 40661-7 | 30,08 |
| 43156-5 | 11,14 |
| 43160-2 | 30,08 |
| 43164-0 | 11,14 |
| 43168-8 | 30,08 |



| | |
|---|--|
| Befestigungsschenkel ausklinken attachment flanges notched | |
| Befestigungsschenkel ausklinken und biegen attachment flanges notched and bent | |

| | |
|---------------------------|------|
| Art./ref. | €/m |
| 22240-8 | 6,76 |
| auf Anfrage on request | |

5. EINSCHUB- & ANSTOßPROFILE / 5. INSERT PROFILES

Andere Eloxalfarben siehe
 Abschnitt 6, Lieferzeit 14 Tage
 other anodized colours see
 section 6, delivery time 14 days

| Profi-Pack à 10 Stück im Bund | | | |
|--------------------------------|-----------|-----------|-------------|
| professional packing à 10 pcs. | | | |
| Farbe/colour | L / l (m) | Art./ref. | €/Stk./pcs. |

| SB-Pack incl. Schr./ Dübel; VE 20 Stk. | |
|---|-------------|
| self-service-pack with screws/ dowels; à 20 pcs. | |
| Art./ref. | €/Stk./pcs. |

532 Einschubprofil 8,5 mm, Aluminium eloxiert, glatt, gebohrt

insert profile 8,5 mm, aluminium
 anodized, smooth, drilled

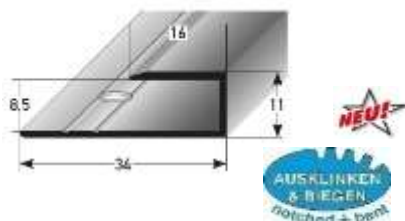

| | | | |
|--|-----|---------|-------|
| silberfarbig silver | 0,9 | 72178-9 | 8,60 |
| | 2,7 | 72180-2 | 25,80 |
| edelstahlfarbig stainless steel coloured | 0,9 | 72186-4 | 11,44 |
| | 2,7 | 72188-8 | 34,30 |
| schwarz black | 0,9 | 72570-1 | 11,44 |
| | 2,7 | 72572-5 | 34,30 |

| | |
|---------|-------|
| 72182-6 | 9,54 |
| 72184-0 | 28,64 |
| 72190-1 | 12,38 |
| 72192-5 | 37,14 |
| 72574-9 | 12,38 |
| 72576-3 | 37,14 |

109 Einschubprofil für Parkett 10 mm, Aluminium eloxiert, gebohrt

insert profile for wooden floor,
 10 mm, aluminium anodized,
 drilled



| | | | |
|--------------------------------|-----|---------|-------|
| silberfarbig silver | 1,0 | 29500-6 | 8,44 |
| | 2,7 | 29505-1 | 22,64 |
| goldfarbig gold | 1,0 | 29510-5 | 9,26 |
| | 2,7 | 29515-0 | 24,96 |
| bronzef. hell bronze light | 1,0 | 29520-4 | 10,70 |
| | 2,7 | 29525-9 | 29,00 |
| bronzef. dunkel bronze dark | 1,0 | 29530-3 | 10,70 |
| | 2,7 | 29535-8 | 29,00 |

| | |
|---------|-------|
| 29506-8 | 9,40 |
| 29507-5 | 25,24 |
| 29516-7 | 10,22 |
| 29517-4 | 27,58 |
| 29526-6 | 11,68 |
| 29527-3 | 31,52 |
| 29536-5 | 11,68 |
| 29537-2 | 31,52 |

110 Einschubprofil für Parkett 13 mm, Aluminium eloxiert, gebohrt

insert profile for wooden floor,
 13 mm, aluminium anodized,
 drilled

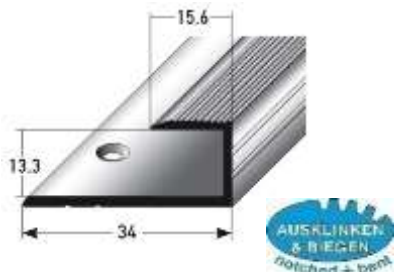

| | | | |
|--------------------------------|-----|---------|-------|
| silberfarbig silver | 1,0 | 29540-2 | 9,16 |
| | 2,7 | 29545-7 | 24,78 |
| goldfarbig gold | 1,0 | 29550-1 | 9,56 |
| | 2,7 | 29555-6 | 25,82 |
| bronzef. hell bronze light | 1,0 | 29560-0 | 11,06 |
| | 2,7 | 29565-5 | 29,74 |
| bronzef. dunkel bronze dark | 1,0 | 29570-9 | 11,06 |
| | 2,7 | 29575-4 | 29,74 |

| | |
|---------|-------|
| 29546-4 | 10,16 |
| 29547-1 | 27,36 |
| 29556-3 | 10,54 |
| 29557-0 | 28,38 |
| 29566-2 | 12,00 |
| 29567-9 | 32,34 |
| 29576-1 | 12,00 |
| 29577-8 | 32,34 |



| |
|---|
| Befestigungsschenkel ausklinken attachment flanges notched |
| Befestigungsschenkel ausklinken und biegen attachment flanges notched and bent |

| | |
|---------------------------|------|
| Art./ref. | €/m |
| 22240-8 | 6,76 |
| auf Anfrage on request | |

5. EINSCHUB- & ANSTOßPROFILE/ 5. INSERT PROFILES

Andere Eloxalfarben siehe
Abschnitt 6, Lieferzeit 14 Tage
other anodized colours see
section 6, delivery time 14 days

| Profi-Pack à 10 Stück im Bund | | | |
|--------------------------------|-----------|-----------|-------------|
| professional packing à 10 pcs. | | | |
| Farbe/colour | L / l (m) | Art./ref. | €/Stk./pcs. |

| SB-Pack incl. Schr./ Dübel; VE 20 Stk. | |
|---|-------------|
| self-service-pack with screws/ dowels; à 20 pcs. | |
| Art./ref. | €/Stk./pcs. |

111 Einschubprofil für Parkett 15 mm, Aluminium eloxiert, gebohrt

insert profile for wooden floor,
15 mm, aluminium anodized,
drilled



Holzdekorfolie/ wood decor

| | | | |
|--------------------------------|-----|---------|-------|
| silberfarbig silver | 1,0 | 29580-8 | 9,78 |
| | 2,7 | 29585-3 | 26,46 |
| goldfarbig gold | 1,0 | 29590-7 | 10,26 |
| | 2,7 | 29595-2 | 27,74 |
| bronzef. hell bronze light | 1,0 | 29600-3 | 11,62 |
| | 2,7 | 29605-8 | 31,36 |
| bronzef. dunkel bronze dark | 1,0 | 29610-2 | 11,62 |
| | 2,7 | 29615-7 | 31,36 |
| gold hell gold light | 1,0 | 62100-3 | 10,26 |
| | 2,7 | 62105-8 | 27,74 |

| | |
|---------|-------|
| 29586-0 | 10,72 |
| 29587-7 | 29,02 |
| 29596-9 | 11,24 |
| 29597-6 | 30,28 |
| 29606-5 | 12,58 |
| 29607-2 | 33,94 |
| 29616-4 | 12,58 |
| 29617-1 | 33,94 |
| 62110-2 | 11,24 |
| 62120-1 | 30,28 |

| | | | |
|------------------------------|-----|---------|-------|
| Buche beech | 1,0 | 40670-9 | 11,54 |
| | 2,7 | 40690-7 | 31,14 |
| Eiche oak | 1,0 | 40700-3 | 11,54 |
| | 2,7 | 40720-1 | 31,14 |
| Ahorn maple | 1,0 | 40730-0 | 11,54 |
| | 2,7 | 40750-8 | 31,14 |
| Kirschbaum cherry wood | 1,0 | 43172-5 | 11,54 |
| | 2,7 | 43176-3 | 31,14 |
| Eiche rustikal rustic oak | 1,0 | 43180-0 | 11,54 |
| | 2,7 | 43184-8 | 31,14 |

| | |
|---------|-------|
| 40671-6 | 12,52 |
| 40691-4 | 33,86 |
| 40701-0 | 12,52 |
| 40721-8 | 33,86 |
| 40731-7 | 12,52 |
| 40751-5 | 33,86 |
| 43174-9 | 12,52 |
| 43178-7 | 33,86 |
| 43182-4 | 12,52 |
| 43186-2 | 33,86 |

533 Einschubprofil 15,5 mm, Aluminium eloxiert, glatt, gebohrt

insert profile 15,5 mm,
aluminium anodized, smooth,
drilled

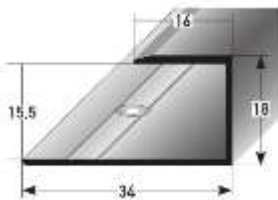

| | | | |
|--|-----|---------|-------|
| silberfarbig silver | 0,9 | 72196-3 | 9,44 |
| | 2,7 | 72198-7 | 28,32 |
| edelstahlfarbig stainless steel coloured | 0,9 | 72204-5 | 12,58 |
| | 2,7 | 72206-9 | 37,76 |
| schwarz black | 0,9 | 72562-6 | 12,58 |
| | 2,7 | 72564-0 | 37,76 |

| | |
|---------|-------|
| 72200-7 | 10,38 |
| 72202-1 | 31,16 |
| 72208-3 | 13,54 |
| 72210-6 | 40,60 |
| 72566-4 | 13,54 |
| 72568-8 | 40,60 |



| |
|---|
| Befestigungsschenkel ausklinken attachment flanges notched |
| Befestigungsschenkel ausklinken und biegen attachment flanges notched and bent |

| Art./ref. | €/m |
|---------------------------|------|
| 22240-8 | 6,76 |
| auf Anfrage on request | |

5. EINSCHUB- & ANSTOßPROFILE / 5. INSERT PROFILES

Andere Eloxalfarben siehe
 Abschnitt 6, Lieferzeit 14 Tage
 other anodized colours see
 section 6, delivery time 14 days

| Profi-Pack à 10 Stück im Bund | | | |
|--------------------------------|-----------|-----------|-------------|
| professional packing à 10 pcs. | | | |
| Farbe/colour | L / l (m) | Art./ref. | €/Stk./pcs. |

| SB-Pack incl. Schr./ Dübel; VE 20 Stk. | |
|---|-------------|
| self-service-pack with screws/ dowels; à 20 pcs. | |
| Art./ref. | €/Stk./pcs. |

21 Einschubprofil 3 mm mit 7 mm Nase, Aluminium eloxiert, gebohrt

insert profile 3 mm with 7 mm
 nose, aluminium anodized,
 drilled



| | | | |
|--------------------------------|-----|---------|-------|
| silberfarbig silver | 0,9 | 32070-8 | 6,54 |
| | 1,0 | 32075-3 | 7,30 |
| | 2,7 | 32080-7 | 19,64 |
| goldfarbig gold | 0,9 | 32085-2 | 6,92 |
| | 1,0 | 32090-6 | 7,70 |
| | 2,7 | 32095-1 | 20,74 |
| bronzef. hell bronze light | 0,9 | 32100-2 | 7,98 |
| | 1,0 | 32105-7 | 8,84 |
| | 2,7 | 32110-1 | 23,84 |
| bronzef. dunkel bronze dark | 0,9 | 32115-6 | 7,98 |
| | 1,0 | 32120-0 | 8,84 |
| | 2,7 | 32125-5 | 23,84 |

| | |
|---------|-------|
| 32071-5 | 7,40 |
| 32076-0 | 8,18 |
| 32081-4 | 22,20 |
| 32086-9 | 7,76 |
| 32091-3 | 8,64 |
| 32096-8 | 23,28 |
| 32101-9 | 8,84 |
| 32106-4 | 9,78 |
| 32111-8 | 26,46 |
| 32116-3 | 8,84 |
| 32121-7 | 9,78 |
| 32126-2 | 26,46 |

534 Einschubprofil 3 mm mit 7 mm Nase, Aluminium eloxiert, glatt, gebohrt

insert profile 3 mm with 7 mm
 nose, aluminium anodized,
 smooth, drilled

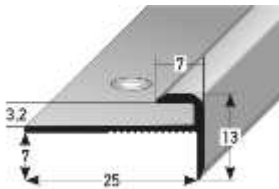

| | | | |
|--|-----|---------|-------|
| silberfarbig silver | 0,9 | 72214-4 | 6,66 |
| | 2,7 | 72216-8 | 19,96 |
| edelstahlfarbig stainless steel coloured | 0,9 | 72222-9 | 8,76 |
| | 2,7 | 72224-3 | 26,30 |
| schwarz black | 0,9 | 72554-1 | 8,76 |
| | 2,7 | 72556-5 | 26,30 |

| | |
|---------|-------|
| 72218-2 | 7,60 |
| 72220-5 | 22,78 |
| 72226-7 | 9,72 |
| 72228-1 | 29,14 |
| 72558-9 | 9,72 |
| 72560-2 | 29,14 |

478 Einschubprofil 3 mm mit 24 mm Nase, Aluminium eloxiert, gebohrt

insert profile 3 mm with 24 mm
 nose, alu anodized, drilled



| | | | |
|--------------------------------|-----|---------|-------|
| silberfarbig silver | 1,0 | 70862-9 | 11,20 |
| | 2,7 | 70864-3 | 30,28 |
| goldfarbig gold | 1,0 | 70870-4 | 11,48 |
| | 2,7 | 70872-8 | 30,94 |
| bronzef. hell bronze light | 1,0 | 70878-0 | 12,96 |
| | 2,7 | 70880-3 | 34,96 |
| bronzef. dunkel bronze dark | 1,0 | 70886-5 | 12,96 |
| | 2,7 | 70888-9 | 34,96 |

| | |
|---------|-------|
| 70866-7 | 12,10 |
| 70868-1 | 32,84 |
| 70874-2 | 12,42 |
| 70876-6 | 33,48 |
| 70882-7 | 13,88 |
| 70884-1 | 37,58 |
| 70890-2 | 13,88 |
| 70892-6 | 37,58 |



| |
|---|
| Befestigungsschenkel ausklinken attachment flanges notched |
| Befestigungsschenkel ausklinken und biegen attachment flanges notched and bent |

| Art./ref. | €/m |
|---------------------------|------|
| 22240-8 | 6,76 |
| auf Anfrage on request | |

5. EINSCHUB- & ANSTOßPROFILE / 5. INSERT PROFILES

Andere Eloxalfarben siehe
 Abschnitt 6, Lieferzeit 14 Tage
 other anodized colours see
 section 6, delivery time 14 days

| Profi-Pack à 10 Stück im Bund | | | |
|--------------------------------|-----------|-----------|-------------|
| professional packing à 10 pcs. | | | |
| Farbe/colour | L / l (m) | Art./ref. | €/Stk./pcs. |

| SB-Pack incl. Schr./ Dübel; VE 20 Stk. | |
|---|-------------|
| self-service-pack with screws/ dowels; à 20 pcs. | |
| Art./ref. | €/Stk./pcs. |

501 Einschubprofil 3 mm mit 44 mm Nase, Aluminium eloxiert, gebohrt

insert profile 3 mm with 44 mm
 nose, alu anodized, drilled



| | | | |
|--------------------------------|-----|---------|-------|
| silberfarbig silver | 1,0 | 71462-0 | 12,10 |
| | 2,7 | 71464-4 | 32,68 |
| goldfarbig gold | 1,0 | 71466-8 | 15,44 |
| | 2,7 | 71468-2 | 41,68 |
| bronzef. hell bronze light | 1,0 | 71470-5 | 17,10 |
| | 2,7 | 71472-9 | 46,14 |
| bronzef. dunkel bronze dark | 1,0 | 71474-3 | 17,86 |
| | 2,7 | 71476-7 | 48,18 |

| | |
|---------|-------|
| 71478-1 | 13,02 |
| 71480-4 | 35,46 |
| 71482-8 | 16,36 |
| 71484-2 | 44,44 |
| 71486-6 | 18,00 |
| 71488-0 | 48,90 |
| 71490-3 | 18,76 |
| 71492-7 | 50,94 |



17 Einschubprofil 5 mm mit 7 mm Nase, Aluminium eloxiert, gebohrt

insert profile 5 mm with 7 mm
 nose, aluminium anodized,
 drilled

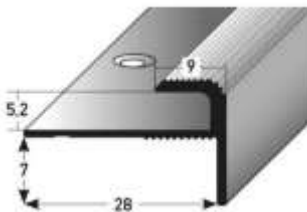

| | | | |
|--------------------------------|-----|---------|-------|
| silberfarbig silver | 0,9 | 27090-4 | 7,86 |
| | 1,0 | 27100-0 | 8,68 |
| | 2,7 | 27130-7 | 23,56 |
| goldfarbig gold | 0,9 | 27190-1 | 8,04 |
| | 1,0 | 27200-7 | 8,92 |
| | 2,7 | 27230-4 | 24,04 |
| bronzef. hell bronze light | 0,9 | 27290-8 | 9,46 |
| | 1,0 | 27300-4 | 10,52 |
| | 2,7 | 27330-1 | 28,30 |
| bronzef. dunkel bronze dark | 0,9 | 27390-5 | 9,46 |
| | 1,0 | 27400-1 | 10,52 |
| | 2,7 | 27430-8 | 28,30 |

| | |
|---------|-------|
| 27091-1 | 8,68 |
| 27101-7 | 9,66 |
| 27131-4 | 26,10 |
| 27191-8 | 8,90 |
| 27201-4 | 9,86 |
| 27231-1 | 26,64 |
| 27291-5 | 10,30 |
| 27301-1 | 11,46 |
| 27331-8 | 30,90 |
| 27391-2 | 10,30 |
| 27401-8 | 11,46 |
| 27431-5 | 30,90 |



535 Einschubprofil 5 mm mit 7 mm Nase, Aluminium eloxiert, glatt, gebohrt

insert profile 5 mm with 7 mm
 nose, aluminium anodized,
 smooth, drilled

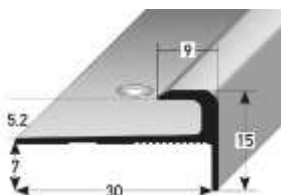

| | | | |
|--|-----|---------|-------|
| silberfarbig silver | 0,9 | 72232-8 | 8,08 |
| | 2,7 | 72234-2 | 24,24 |
| edelstahlfarbig stainless steel coloured | 0,9 | 72240-3 | 10,50 |
| | 2,7 | 72242-7 | 31,48 |
| schwarz black | 0,9 | 72546-6 | 10,50 |
| | 2,7 | 72548-0 | 31,48 |

| | |
|---------|-------|
| 72236-6 | 9,02 |
| 72238-0 | 27,06 |
| 72244-1 | 11,44 |
| 72246-5 | 34,30 |
| 72550-3 | 11,44 |
| 72552-7 | 34,30 |



| |
|---|
| Befestigungsschenkel ausklinken attachment flanges notched |
| Befestigungsschenkel ausklinken und biegen attachment flanges notched and bent |

| Art./ref. | €/m |
|---------------------------|------|
| 22240-8 | 6,76 |
| auf Anfrage on request | |

5. EINSCHUB- & ANSTOßPROFILE / 5. INSERT PROFILES

Andere Eloxalfarben siehe
Abschnitt 6, Lieferzeit 14 Tage
other anodized colours see
section 6, delivery time 14 days

| Profi-Pack à 10 Stück im Bund | | | |
|--------------------------------|-----------|-----------|-------------|
| professional packing à 10 pcs. | | | |
| Farbe/colour | L / l (m) | Art./ref. | €/Stk./pcs. |

| SB-Pack incl. Schr./ Dübel; VE 20 Stk. | |
|---|-------------|
| self-service-pack with screws/ dowels; à 20 pcs. | |
| Art./ref. | €/Stk./pcs. |

93 Treppeneinschubprofil 5 mm mit 24 mm Nase, Aluminium eloxiert, gebohrt

insert profile 5 mm with 24 mm
nose, aluminium anodized,
drilled



| | | | |
|--------------------------------|-----|---------|-------|
| silberfarbig silver | 0,9 | 32005-0 | 11,32 |
| | 1,0 | 32010-4 | 12,60 |
| | 2,7 | 32015-9 | 34,02 |
| goldfarbig gold | 0,9 | 32020-3 | 11,44 |
| | 1,0 | 32025-8 | 12,68 |
| | 2,7 | 32030-2 | 34,28 |
| bronzef. hell bronze light | 0,9 | 32035-7 | 13,16 |
| | 1,0 | 32040-1 | 14,60 |
| | 2,7 | 32045-6 | 39,34 |
| bronzef. dunkel bronze dark | 0,9 | 32050-0 | 13,16 |
| | 1,0 | 32055-5 | 14,60 |
| | 2,7 | 32060-9 | 39,34 |

| | |
|---------|-------|
| 32006-7 | 12,22 |
| 32011-1 | 13,56 |
| 32016-6 | 36,62 |
| 32021-0 | 12,28 |
| 32026-5 | 13,62 |
| 32031-9 | 36,82 |
| 32036-4 | 13,98 |
| 32041-8 | 15,52 |
| 32046-3 | 41,92 |
| 32051-7 | 13,98 |
| 32056-2 | 15,52 |
| 32061-6 | 41,92 |

502 Treppeneinschubprofil 5 mm mit 44 mm Nase, Aluminium eloxiert, gebohrt

insert profile 5 mm with 44 mm
nose, aluminium anodized,
drilled



| | | | |
|--------------------------------|-----|---------|-------|
| silberfarbig silver | 1,0 | 71498-9 | 12,38 |
| | 2,7 | 71500-9 | 33,40 |
| goldfarbig gold | 1,0 | 71502-3 | 15,74 |
| | 2,7 | 71504-7 | 42,50 |
| bronzef. hell bronze light | 1,0 | 71506-1 | 17,44 |
| | 2,7 | 71508-5 | 47,08 |
| bronzef. dunkel bronze dark | 1,0 | 71510-8 | 18,18 |
| | 2,7 | 71512-2 | 49,14 |

| | |
|---------|-------|
| 71514-6 | 13,28 |
| 71516-0 | 36,16 |
| 71518-4 | 16,66 |
| 71520-7 | 45,28 |
| 71522-1 | 18,36 |
| 71524-5 | 49,84 |
| 71526-9 | 19,12 |
| 71528-3 | 51,90 |

105 Einschubprofil 8,5 mm mit 7 mm Nase für Laminat, Aluminium eloxiert, gebohrt

insert profile 8,5 mm with 7 mm
nose, aluminium anodized,
drilled

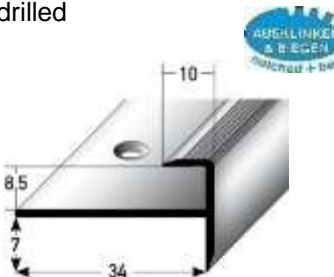

| | | | |
|--------------------------------|-----|---------|-------|
| silberfarbig silver | 1,0 | 32140-8 | 9,70 |
| | 2,7 | 32145-3 | 26,20 |
| goldfarbig gold | 1,0 | 32155-2 | 10,02 |
| | 2,7 | 32160-6 | 26,98 |
| bronzef. hell bronze light | 1,0 | 32170-5 | 10,58 |
| | 2,7 | 32175-0 | 28,54 |
| bronzef. dunkel bronze dark | 1,0 | 32185-9 | 10,58 |
| | 2,7 | 32190-3 | 28,54 |
| gold hell gold light | 1,0 | 62175-1 | 10,02 |
| | 2,7 | 62180-5 | 26,98 |

| | |
|---------|-------|
| 32141-5 | 10,64 |
| 32146-0 | 29,08 |
| 32156-9 | 10,96 |
| 32161-3 | 29,84 |
| 32171-2 | 11,52 |
| 32176-7 | 31,38 |
| 32186-6 | 11,52 |
| 32191-0 | 31,38 |
| 62190-4 | 10,96 |
| 62195-9 | 29,84 |



| |
|---|
| Befestigungsschenkel ausklinken attachment flanges notched |
|---|

| Art./ref. | €/m |
|-----------|------|
| 22240-8 | 6,76 |

| |
|---|
| Befestigungsschenkel ausklinken und biegen attachment flanges notched and bent |
|---|

| |
|---------------------------|
| auf Anfrage on request |
|---------------------------|

5. EINSCHUB- & ANSTOßPROFILE/ 5. INSERT PROFILES

Andere Eloxalfarben siehe
Abschnitt 6, Lieferzeit 14 Tage
other anodized colours see
section 6, delivery time 14 days

| Profi-Pack à 10 Stück im Bund | | | |
|--------------------------------|-----------|-----------|-------------|
| professional packing à 10 pcs. | | | |
| Farbe/colour | L / l (m) | Art./ref. | €/Stk./pcs. |

| SB-Pack incl. Schr./ Dübel; VE 20 Stk. | |
|---|-------------|
| self-service-pack with screws/ dowels; à 20 pcs. | |
| Art./ref. | €/Stk./pcs. |

265 Einschubprofil 8,5 mm mit 44 mm Nase für Laminat, Aluminium eloxiert, gebohrt

insert profile 8,5 mm with 44 mm
nose, aluminium anodized, drilled

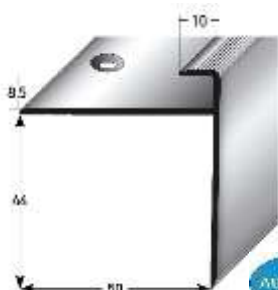

| | | | | | |
|--------------------------------|-----|---------|-------|---------|-------|
| silberfarbig silver | 1,0 | 46234-7 | 15,72 | 46240-8 | 16,64 |
| | 2,7 | 46236-1 | 42,42 | | |
| goldfarbig gold | 1,0 | 46248-4 | 16,38 | 46242-2 | 45,28 |
| | 2,7 | 46250-7 | 44,30 | | |
| bronzef. hell bronze light | 1,0 | 46262-0 | 18,04 | 46254-5 | 17,32 |
| | 2,7 | 46264-4 | 48,68 | | |
| bronzef. dunkel bronze dark | 1,0 | 46276-7 | 18,04 | 46256-9 | 47,14 |
| | 2,7 | 46278-1 | 48,68 | | |
| gold hell gold light | 1,0 | 46438-9 | 16,38 | 46268-2 | 18,98 |
| | 2,7 | 46440-2 | 44,30 | | |
| | 1,0 | | | 46270-5 | 51,52 |
| | 2,7 | | | | |
| | 1,0 | | | 46282-8 | 18,98 |
| | 2,7 | | | | |
| | 1,0 | | | 46284-2 | 51,52 |
| | 2,7 | | | | |
| | 1,0 | | | 46442-6 | 17,32 |
| | 2,7 | | | | |
| | 1,0 | | | 46444-0 | 47,14 |
| | 2,7 | | | | |

262 Einschubprofil 10 mm mit 7 mm Nase für Parkett, Aluminium eloxiert, gebohrt

insert profile 10 mm, with 7mm
nose, aluminium anodized, drilled

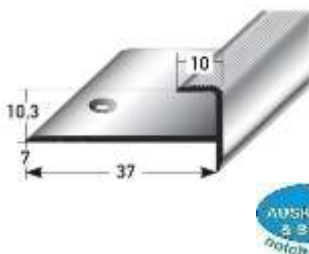

| | | | | | |
|--------------------------------|-----|---------|-------|---------|-------|
| silberfarbig silver | 1,0 | 46122-7 | 10,30 | 46128-9 | 11,26 |
| | 2,7 | 46124-1 | 27,86 | | |
| goldfarbig gold | 1,0 | 46136-4 | 10,74 | 46130-2 | 30,72 |
| | 2,7 | 46138-8 | 29,08 | | |
| bronzef. hell bronze light | 1,0 | 46150-0 | 11,76 | 46142-5 | 11,70 |
| | 2,7 | 46152-4 | 31,84 | | |
| bronzef. dunkel bronze dark | 1,0 | 46164-7 | 11,76 | 46144-9 | 31,92 |
| | 2,7 | 46166-1 | 31,84 | | |
| gold hell gold light | 1,0 | 46448-8 | 10,74 | 46156-2 | 12,72 |
| | 2,7 | 46450-1 | 29,08 | | |
| | 1,0 | | | 46158-6 | 34,70 |
| | 2,7 | | | | |
| | 1,0 | | | 46170-8 | 12,72 |
| | 2,7 | | | | |
| | 1,0 | | | 46172-2 | 34,70 |
| | 2,7 | | | | |
| | 1,0 | | | 46452-5 | 11,70 |
| | 2,7 | | | | |
| | 1,0 | | | 46454-9 | 31,92 |
| | 2,7 | | | | |

427 Einschubprofil 10,5 mm mit 44 mm Nase für Parkett, Aluminium eloxiert, gebohrt

insert profile 10,5 mm with 44 mm
nose, aluminium anodized, drilled

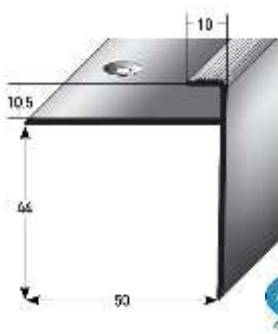

| | | | | | |
|--------------------------------|-----|---------|-------|---------|-------|
| silberfarbig silver | 1,0 | 67100-8 | 16,56 | 67124-4 | 17,50 |
| | 2,7 | 67102-2 | 44,66 | | |
| goldfarbig gold | 1,0 | 67104-6 | 17,20 | 67126-8 | 47,50 |
| | 2,7 | 67106-0 | 46,50 | | |
| bronzef. hell bronze light | 1,0 | 67112-1 | 18,86 | 67128-2 | 18,14 |
| | 2,7 | 67114-5 | 50,92 | | |
| bronzef. dunkel bronze dark | 1,0 | 67116-9 | 18,86 | 67130-5 | 49,30 |
| | 2,7 | 67118-3 | 50,92 | | |
| gold hell gold light | 1,0 | 67108-4 | 17,20 | 67136-7 | 19,78 |
| | 2,7 | 67110-7 | 46,50 | | |
| | 1,0 | | | 67138-1 | 53,68 |
| | 2,7 | | | | |
| | 1,0 | | | 67140-4 | 19,78 |
| | 2,7 | | | | |
| | 1,0 | | | 67142-8 | 53,68 |
| | 2,7 | | | | |
| | 1,0 | | | 67132-9 | 18,14 |
| | 2,7 | | | | |
| | 1,0 | | | 67134-3 | 49,30 |
| | 2,7 | | | | |



| | | |
|---|---------------------------|------|
| Befestigungsschenkel ausklinken attachment flanges notched | Art./ref. | €/m |
| Befestigungsschenkel ausklinken und biegen attachment flanges notched and bent | 22240-8 | 6,76 |
| | auf Anfrage on request | |

5. EINSCHUB- & ANSTOßPROFILE/ 5. INSERT PROFILES

Andere Eloxalfarben siehe
 Abschnitt 6, Lieferzeit 14 Tage
 other anodized colours see
 section 6, delivery time 14 days

| Profi-Pack à 10 Stück im Bund | | | |
|--------------------------------|-----------|-----------|-------------|
| professional packing à 10 pcs. | | | |
| Farbe/colour | L / l (m) | Art./ref. | €/Stk./pcs. |

| SB-Pack incl. Schr./ Dübel; VE 20 Stk. | |
|---|-------------|
| self-service-pack with screws/ dowels; à 20 pcs. | |
| Art./ref. | €/Stk./pcs. |

263 Einschubprofil 13 mm mit 7 mm Nase für Parkett, Aluminium eloxiert, gebohrt

insert profile 13 mm with 7mm
 nose, aluminium anodized, drilled

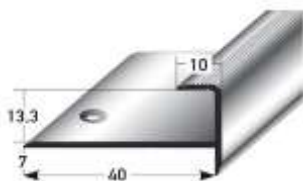

| | | | | | |
|--------------------------------|-----|---------|-------|---------|-------|
| silberfarbig silver | 1,0 | 46178-4 | 11,14 | 46184-5 | 12,10 |
| | 2,7 | 46180-7 | 30,12 | | |
| goldfarbig gold | 1,0 | 46192-0 | 11,56 | 46186-9 | 32,96 |
| | 2,7 | 46194-4 | 31,28 | | |
| bronzef. hell bronze light | 1,0 | 46206-4 | 12,60 | 46198-2 | 12,52 |
| | 2,7 | 46208-8 | 34,00 | | |
| bronzef. dunkel bronze dark | 1,0 | 46220-0 | 12,60 | 46200-2 | 34,14 |
| | 2,7 | 46222-4 | 34,00 | | |
| gold hell gold light | 1,0 | 46458-7 | 11,56 | 46212-5 | 13,56 |
| | 2,7 | 46460-0 | 31,28 | | |

| | | | |
|---------|-------|---------|-------|
| 46184-5 | 12,10 | 46214-9 | 36,88 |
| | | | |
| 46186-9 | 32,96 | 46228-6 | 36,88 |
| | | | |
| 46200-2 | 34,14 | 46464-8 | 34,14 |

112 Einschubprofil 15 mm mit 12 mm Nase für Parkett, Aluminium eloxiert, gebohrt

insert profile 15 mm, with 12 mm
 nose, aluminium anodized, drilled

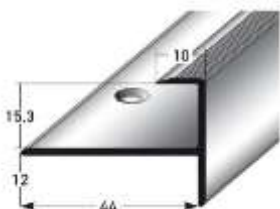

| | | | | | |
|--------------------------------|-----|---------|-------|---------|-------|
| silberfarbig silver | 1,0 | 37020-8 | 9,76 | 37021-5 | 10,62 |
| | 2,7 | 37030-7 | 26,30 | | |
| goldfarbig gold | 1,0 | 37040-6 | 12,84 | 37031-4 | 29,04 |
| | 2,7 | 37050-5 | 34,70 | | |
| bronzef. hell bronze light | 1,0 | 37060-4 | 13,42 | 37041-3 | 13,78 |
| | 2,7 | 37070-3 | 36,26 | | |
| bronzef. dunkel bronze dark | 1,0 | 37080-2 | 13,42 | 37051-2 | 37,56 |
| | 2,7 | 37090-1 | 36,26 | | |
| gold hell gold light | 1,0 | 62210-9 | 12,84 | 37061-1 | 14,36 |
| | 2,7 | 62215-4 | 34,70 | | |

| | | | |
|---------|-------|---------|-------|
| 37021-5 | 10,62 | 37071-0 | 39,10 |
| | | | |
| 37031-4 | 29,04 | 37091-8 | 39,10 |
| | | | |
| 37051-2 | 37,56 | 62230-7 | 37,56 |



| | | |
|---|---------------------------|------|
| Befestigungsschenkel ausklinken attachment flanges notched | Art./ref. | €/m |
| Befestigungsschenkel ausklinken und biegen attachment flanges notched and bent | 22240-8 | 6,76 |
| | auf Anfrage on request | |

| | |
|-----------|---------------------------|
| Art./ref. | €/m |
| 22240-8 | 6,76 |
| | auf Anfrage on request |

5. EINSCHUB- & ANSTOßPROFILE/ 5. INSERT PROFILES

Andere Eloxalfarben siehe
 Abschnitt 6, Lieferzeit 14 Tage
 other anodized colours see
 section 6, delivery time 14 days

| Profi-Pack à 10 Stück im Bund | | | |
|--------------------------------|-----------|-----------|-------------|
| professional packing à 10 pcs. | | | |
| Farbe/colour | L / l (m) | Art./ref. | €/Stk./pcs. |

| SB-Pack incl. Schr./ Dübel; VE 20 Stk. | |
|---|-------------|
| self-service-pack with screws/ dowels; à 20 pcs. | |
| Art./ref. | €/Stk./pcs. |

101 Treppenkante für Laminat 20 x 33 x 8,5 mm, Aluminium eloxiert, 2 x gebohrt

stair nosing for laminate
 20 x 33 x 8,5 mm,
 aluminium anodized, 2 x drilled



| | | | | | |
|--------------------------------|-----|---------|-------|---------|-------|
| silberfarbig silver | 1,0 | 29100-8 | 15,68 | 29101-5 | 16,62 |
| | 2,5 | 29110-7 | 39,24 | | |
| goldfarbig gold | 1,0 | 29115-2 | 16,30 | 29111-4 | 42,06 |
| | 2,5 | 29125-1 | 40,80 | | |
| bronzef. hell bronze light | 1,0 | 29130-5 | 17,60 | 29116-9 | 17,24 |
| | 2,5 | 29140-4 | 44,06 | | |
| bronzef. dunkel bronze dark | 1,0 | 29145-9 | 17,60 | 29126-8 | 43,64 |
| | 2,5 | 29155-8 | 44,06 | | |
| gold hell gold light | 1,0 | 62300-7 | 16,30 | 29131-2 | 18,56 |
| | 2,5 | 62310-6 | 40,80 | | |
| | | | | 29141-1 | 46,96 |
| | | | | 29146-6 | 18,56 |
| | | | | 29156-5 | 46,96 |
| | | | | 62315-1 | 17,20 |
| | | | | 62320-5 | 43,64 |

259 Treppenkante für Parkett 20 x 33 x 10 mm, Aluminium eloxiert, 2 x gebohrt

stair nosing for parquet
 20 x 33 x 10 mm,
 aluminium anodized, 2 x drilled

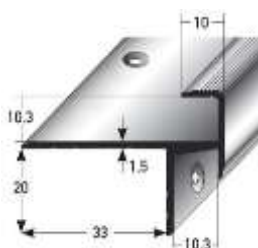

| | | | | | |
|--------------------------------|-----|---------|-------|---------|-------|
| silberfarbig silver | 1,0 | 46288-0 | 15,98 | 46292-7 | 16,90 |
| | 2,5 | 46290-3 | 39,94 | | |
| goldfarbig gold | 1,0 | 46298-9 | 16,56 | 46294-1 | 42,82 |
| | 2,5 | 46300-9 | 41,36 | | |
| bronzef. hell bronze light | 1,0 | 46308-5 | 17,92 | 46302-3 | 17,50 |
| | 2,5 | 46310-8 | 44,82 | | |
| bronzef. dunkel bronze dark | 1,0 | 46318-4 | 17,92 | 46304-7 | 44,18 |
| | 2,5 | 46320-7 | 44,82 | | |
| gold hell gold light | 1,0 | 46408-2 | 16,56 | 46312-2 | 18,86 |
| | 2,5 | 46410-5 | 41,36 | | |
| | | | | 46314-6 | 47,64 |
| | | | | 46322-1 | 18,86 |
| | | | | 46324-5 | 47,64 |
| | | | | 46412-9 | 17,50 |
| | | | | 46414-3 | 44,18 |

260 Treppenkante für Parkett 20 x 33 x 13 mm, Aluminium eloxiert, 2 x gebohrt

stair nosing for parquet
 20 x 33 x 13 mm,
 aluminium anodized, 2 x drilled

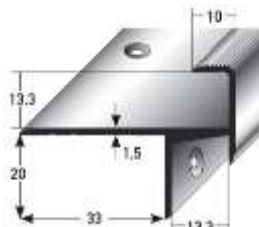

| | | | | | |
|--------------------------------|-----|---------|-------|---------|-------|
| silberfarbig silver | 1,0 | 46328-3 | 17,02 | 46332-0 | 17,96 |
| | 2,5 | 46330-6 | 42,50 | | |
| goldfarbig gold | 1,0 | 46338-2 | 17,60 | 46334-4 | 45,38 |
| | 2,5 | 46340-5 | 44,06 | | |
| bronzef. hell bronze light | 1,0 | 46348-1 | 19,08 | 46342-9 | 18,56 |
| | 2,5 | 46350-4 | 47,64 | | |
| bronzef. dunkel bronze dark | 1,0 | 46358-0 | 19,08 | 46344-3 | 46,96 |
| | 2,5 | 46360-3 | 47,64 | | |
| gold hell gold light | 1,0 | 46418-1 | 17,60 | 46352-8 | 20,02 |
| | 2,5 | 46420-4 | 44,06 | | |
| | | | | 46354-2 | 50,52 |
| | | | | 46362-7 | 20,02 |
| | | | | 46364-1 | 50,52 |
| | | | | 46422-8 | 18,56 |
| | | | | 46424-2 | 46,96 |

261 Treppenkante für Parkett 20 x 33 x 15 mm, Aluminium eloxiert, 2 x gebohrt

stair nosing for parquet
 20 x 33 x 15 mm,
 aluminium anodized,
 2 x drilled

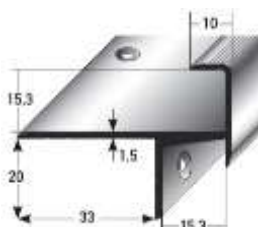

| | | | | | |
|--------------------------------|-----|---------|-------|---------|-------|
| silberfarbig silver | 1,0 | 46368-9 | 17,48 | 46372-6 | 18,38 |
| | 2,5 | 46370-2 | 43,64 | | |
| goldfarbig gold | 1,0 | 46378-8 | 18,08 | 46374-0 | 46,52 |
| | 2,5 | 46380-1 | 45,20 | | |
| bronzef. hell bronze light | 1,0 | 46388-7 | 19,10 | 46382-5 | 19,04 |
| | 2,5 | 46390-0 | 48,96 | | |
| bronzef. dunkel bronze dark | 1,0 | 46398-6 | 19,10 | 46384-9 | 48,08 |
| | 2,5 | 46400-6 | 48,96 | | |
| gold hell gold light | 1,0 | 46428-0 | 18,08 | 46392-4 | 20,56 |
| | 2,5 | 46430-3 | 45,20 | | |
| | | | | 46394-8 | 51,86 |
| | | | | 46402-0 | 20,56 |
| | | | | 46404-4 | 51,86 |
| | | | | 46432-7 | 19,04 |
| | | | | 46434-1 | 48,08 |

6. LED + SERVICE

6. LED + SERVICE



6. LED + SERVICE/ 6. LED + SERVICE

LED-beleuchtete Treppenkanten

LED-lighted stair nosings

Angebotserstellung erfolgt nach objektspezifischer Anfrage / offer only by object-specific request

Farbe & Material / colour+material

Art./ref.

309 Treppenkante 21 x 37 mm, für direkte Beleuchtung, Aluminum eloxiert, gebohrt

stair nosing 21x37 mm, for direct lighting, aluminum anodized, drilled



| | |
|---|---------|
| silberfarbig/ silver | 47990-1 |
| goldfarbig/ gold | 47992-5 |
| bronzefarbig hell/ bronze light | 47994-9 |
| bronzefarbig dunkel/ bronze dark | 47996-3 |
| edelstahlfarbig/ stainless steel coloured | 47998-7 |

513 Treppenkante 40 x 45 mm, für indirekte Beleuchtung, Aluminum eloxiert, gebohrt

stair nosing 40x45 mm, for indirect lighting, aluminum anodized, drilled



| | |
|---|---------|
| silberfarbig/ silver | 71754-6 |
| goldfarbig/ gold | 71756-0 |
| bronzefarbig hell/ bronze light | 71758-4 |
| bronzefarbig dunkel/ bronze dark | 71760-7 |
| edelstahlfarbig/ stainless steel coloured | 71762-1 |

Abdeckung zum Einschleiben in die Treppenkante

cover to slide into the stair nosing

| | | |
|---|--------------------------|---------|
| PVC-Rohr 10 x 10 mm PVC-pipe 10 x 10 mm | transparent/ transparent | 48010-5 |
| | rot/ red | 48008-2 |
| | grün/ green | 48006-8 |
| | gelb/ yellow | 48002-0 |
| PVC-Streifen 12 mm, transluzent / PVC-stripe 12 mm, translucent | | 71764-5 |

LED-Beleuchtungsstreifen selbstklebend

LED-lighting strip self-adhesive

| | |
|--|---------|
| 12 V, warmweiß 10 LED/lfm., alle 3 LED/ 25 cm teilbar 12 V, warm white 10 LED/m, every 3 LED/ 25 cm divisible | 48014-3 |
| 12 V, warmweiß 30 LED/lfm., 8 mm breit, alle 3 LED/ 10 cm teilbar 12 V, warm white 30 LED/m, 8 mm wide, every 3 LED/ 10 cm divisible | 48016-7 |
| 24 V, warmweiß ca. 500 LED/lfm., 10 mm breit, alle 4,2 cm teilbar 24 V, warm white, approx. 500 LED/m, 10 mm wide, every 4,2 cm divisible | 71966-3 |

Stromanschlussvarianten/ power connector variants

Die Wahl des Netzteils ist abhängig von den LED's.

The choice of the power supply depends also on the LED's.

| | |
|--|---------|
| Steckernetzteil 24 W / power supply 24 W | 48026-6 |
| Steckernetzteil 48 W / power supply 48 W | 48028-0 |
| Einbaunetzteil 12 W / built-in power supply 12 W | 48030-3 |
| Einbaunetzteil 60 W / built-in power supply 60 W | 48032-7 |
| Einbaunetzteil 100 W / built-in power supply 100 W | 48034-1 |

Dienstleistung/ service

| | |
|--|---------|
| Rundum-Sorglos-Paket: wir liefern aufschraubfertig! Anschlusskabel gelötet, inkl. seitlicher Abdeckkappen All-round carefree package: we deliver ready-to-screw! Connection cable soldered, including side caps | 48038-9 |
|--|---------|

6. LED + SERVICE/ 6. LED + SERVICE

Sockelleisten mit LED-Beleuchtung

skirtings with LED lighting

Komponentenauswahl/ component selection:

| Farbe/ colour | L / l (m) | Art./ref. | €/m |
|---------------|-----------|-----------|-----|
|---------------|-----------|-----------|-----|

514 Sockelleiste 60 mm, für indirekte LED-Beleuchtung, Aluminum eloxiert, ungebohrt

skirting 60 mm, for indirect LED lighting aluminum anodized, undrilled



| | | | |
|---|-----|---|---------|
| silberfarbig/ silver | 2,5 | 71768-3 | 15,36/m |
| Pulvern n. RAL; Preis ab 150 lfm. powder RAL; price from 150 m | | 71770-6 | 18,46/m |
| | | Pulvern nach RAL unter 150 lfm. auf Anfrage powdered (RAL) less than 150 m on request | |

Sockelleiste mit 2 Kanälen: 1x für Stromversorgung + 1x für LED-Beleuchtung
skirting with 2 channels: 1x for power supply + 1x for LED lighting

515 Sockelleiste 100 mm, für indirekte LED-Beleuchtung, Aluminum eloxiert, ungebohrt

skirting 100 mm, for indirect LED lighting, aluminum anodized, undrilled

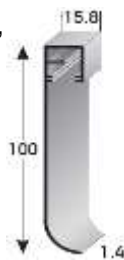

| | | | |
|---|-----|---|---------|
| silberfarbig/ silver | 2,5 | 71774-4 | 20,32/m |
| Pulvern n. RAL; Preis ab 150 lfm. powder RAL; price from 150 m | | 71776-8 | 23,42/m |
| | | Pulvern nach RAL unter 150 lfm. auf Anfrage powdered (RAL) less than 150 m on request | |

Sockelleiste mit 2 Kanälen: 1x für Stromversorgung + 1x für LED-Beleuchtung
skirting with 2 channels: 1x for power supply + 1x for LED lighting

LED-Beleuchtungsstreifen selbstklebend
LED lighting strip self-adhesive

| | | |
|--|---------|---------------------------------------|
| 12 V, warmweiß 30 LED/lfm. , 8 mm breit, alle 3 LED/ 10 cm teilbar 12 V, warm white 30 LED/m, 8 mm wide, every 3 LED/ 10 cm divisible | 48016-7 | Preis auf Anfrage price on request |
| 24 V, warmweiß ca. 500 LED/lfm. , 10 mm breit, alle 4,2 cm teilbar 24 V, warm white, approx. 500 LED/m, 10 mm wide, every 4,2 cm divisible | 71966-3 | |

Eckverbinder für LED-Streifen
LED corner connector

| | | |
|---|---------|---------------------------------------|
| 4-poliger Eckverbinder für 8 und 10 mm breite LED-Streifen 4-pole corner connector for 8 and 10 mm wide LED strips | 71860-4 | Preis auf Anfrage price on request |
|---|---------|---------------------------------------|

Kühlstreifen 10 x 1 mm
cooling strips 10 x 1 mm

| | | |
|---|---------|--------|
| optional zum Aufkleben der LEDs, 1,0 m optional for gluing the LEDs, 1,0 m | 71864-2 | 1,36/m |
|---|---------|--------|

transluzente Abdeckung zum Einschieben
translucent cover to slide in

| | | |
|---|---------|-----------------------|
| PVC-Streifen 12 mm, transluzent, Rolle à 25 m PVC-stripe 12 mm, translucent, roll a 25 m | 71764-5 | 2,56/m 63,74 €/Ro. |
|---|---------|-----------------------|

Für Zuschnitte erheben wir einen Arbeitsaufschlag von 15 %.
For cuttings we charge a labor surcharge of 15%.

Stromanschlussvarianten/ power connector variants

Die Wahl des Netzteils ist abhängig von der LED-Streifenlänge.
The choice of the power supply depends from the LED strip length.

| | | |
|--|---------|---------------------------------------|
| Steckernetzteil 24 W / power supply 24 W | 48026-6 | Preis auf Anfrage price on request |
| Steckernetzteil 48 W / power supply 48 W | 48028-0 | |
| Einbaunetzteil 12 W / built-in power supply 12 W | 48030-3 | |
| Einbaunetzteil 60 W / built-in power supply 60 W | 48032-7 | |
| Einbaunetzteil 100 W / built-in power supply 100 W | 48034-1 | |

6. LED + SERVICE/ 6. LED + SERVICE

Serviceleistungen für unsere Kunden/ services for our customers

- ☞ Sonderlängenzuschnitt, Längsteilen von Profilen, Profile ohne Bohrungen oder pressblank, Sonderbohrungen (Durchmesser + Bohrbilder + Lochabstand) auf Anfrage möglich
special length cuts, lengthwise cutting of profiles, profiles without holes or mill finish and special drilling (diameter / drilling patterns / hole spacing)
 - ☞ andere Farben und Oberflächen auf Anfrage:
andere Eloxalfarben (gold hell, schwarz, edelstahlfarbig), Pulverbeschichten nach RAL, Emaillieren, Brünieren, Vergolden, Zaponlackieren
other colours and surfaces on request:
other anodized colours (gold light, black, stainless steel coloured), powder coating according to RAL, enamelling, brass burnished, gilding, zapon varnishing
 - ☞ Mattschleifen, Anphasen, Gehrungsschnitte, Rahmenfertigung, Profilmontage nach Skizze, Laserbearbeitung von Edelstahl, Messing, Aluminium und Kupfer, Laserschweißen
matt grinding, chamfering, miter cuts, frame production, profile production according to sketch, laser processing of stainless steel, brass, aluminum and copper, laser welding
 - ☞ Biegen von Profilen nach Schablone oder Radiusangabe (nach vorheriger Absprache)
bending of profiles with template or radius specification (by prior arrangement)
 - ☞ Einschweißen von Profilen / profiles shrink-wrapped in foil
- und vieles mehr / and much more

Technische Datenblätter, Verlegehinweise, Materialbeschreibungen & Pflegehinweise erhalten Sie gern auf Anfrage oder unter www.Auer-Metallprofile.de

Technical details, installation tips, material descriptions and care instructions are available on request
or under www.Auer-metallprofile.de



Beispiel: Winkelprofil aus Aluminium, gebogen
example: aluminium angle edge bent

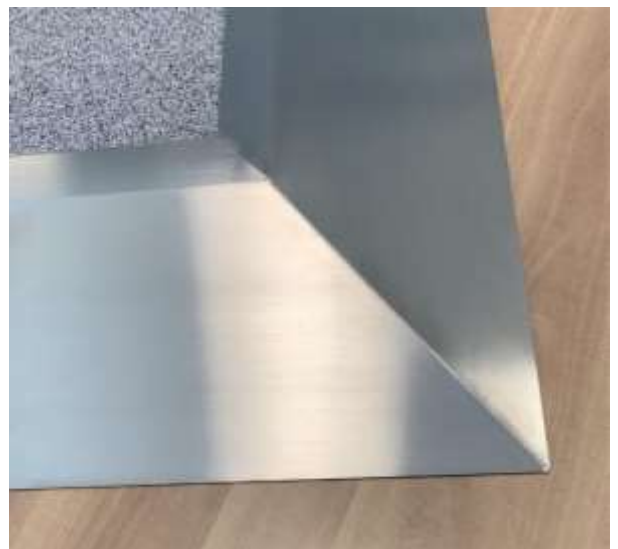

Beispiel: Edelstahl-Niveauequalisierungsecke, feingeschweißt
Example: stainless steel level compensation corner, finely welded

6. LED + SERVICE/ 6. LED + SERVICE

Serviceleistungen für unsere Kunden/ services for our customers

Befestigungsschenkel ausklinken
 attachment flanges notched



doppelte Anzahl Bohrlöcher
 twice the number of drill holes

| | |
|-----------|------|
| Art./ref. | €/m |
| 22240-8 | 6,76 |

zusätzlich zum Materialpreis/ in addition to the material price

Profile können in Radien größer als ca. 3,0 m vor Ort gebogen werden.
 Profiles with radius larger than 3,0 m can be bent at installation location.

Von Profil zu Profil können große Unterschiede in der Biegefähigkeit bestehen.
 There may be substantial variations in the possibility of bending different profiles.

Befestigungsschenkel ausklinken und biegen
 attachment flanges notched and bent



Befestigungsschenkel für alle gängigen Einfass- und Einschubprofile ausklinken und Profil biegen nach Schablone, Skizze oder Radius.

Attachment flanges for all common insert profiles notched and bent according to template, sketch or radius.



Bitte immer die Biegerichtung mit angeben!

Please specify the bending direction!

| | |
|-----------|-----------------|
| Art./ref. | €/Radius/radius |
| 22241-5 | 182,92 |

zusätzlich zum Materialpreis/ in addition to the material price

Die Aufbewahrungsfrist für Schablonen in Aue beträgt maximal 6 Monate!
 Important: We keep templates in Aue for a max. of 6 months!

Achtung!! Bei Winkel- und Übergangprofilen kann der Biegeaufwand höher sein. Bitte extra anfragen!

Attention! For angles and connecting profiles the bending effort can be higher.
 Please inquire separately!

251 Säulenringe biegen

pillar ring bent



Abbildung nur symbolhaft
 illustration only symbolic

zusätzlich zum Materialpreis/ in addition to the material price

| Ø mm | Art./ref. | €/Ring/pillar ring |
|-----------|-----------|--------------------|
| Ø 200-300 | 45720-6 | 99,52 |
| Ø 301-400 | 45725-1 | 92,12 |
| Ø 401-500 | 45730-5 | 84,70 |
| Ø 501-X | 45735-0 | 84,70 |

Fertigung in 2 Halbschalen/ manufactured in two halves

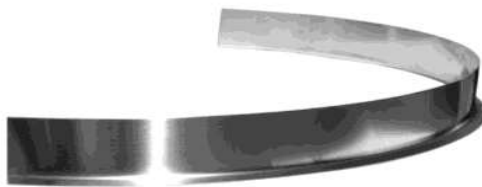
Dehnungsfugenprofil gebogen
 expansion gap profile, bent



Übergangprofil gebogen/ connecting profile curved

Einschubprofil mit Nase aus Edelstahl, gebogen
 stainless steel nosed insert profile, bent

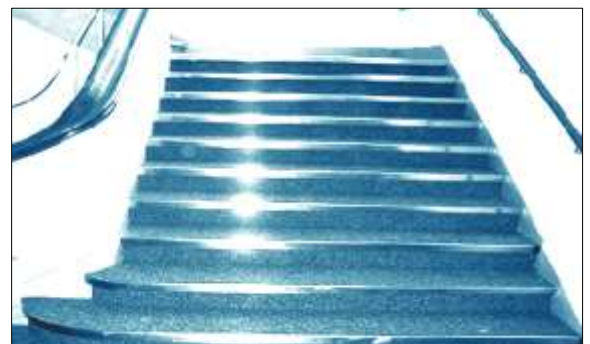

7. SYSTEMPROFILE AUS ALUMINIUM & EDELSTAHL FÜR 4-24mm BELÄGE

7. SYSTEM PROFILES OUT OF ALUMINIUM + STAINLESS STEEL
FOR 4-24mm FLOORINGS

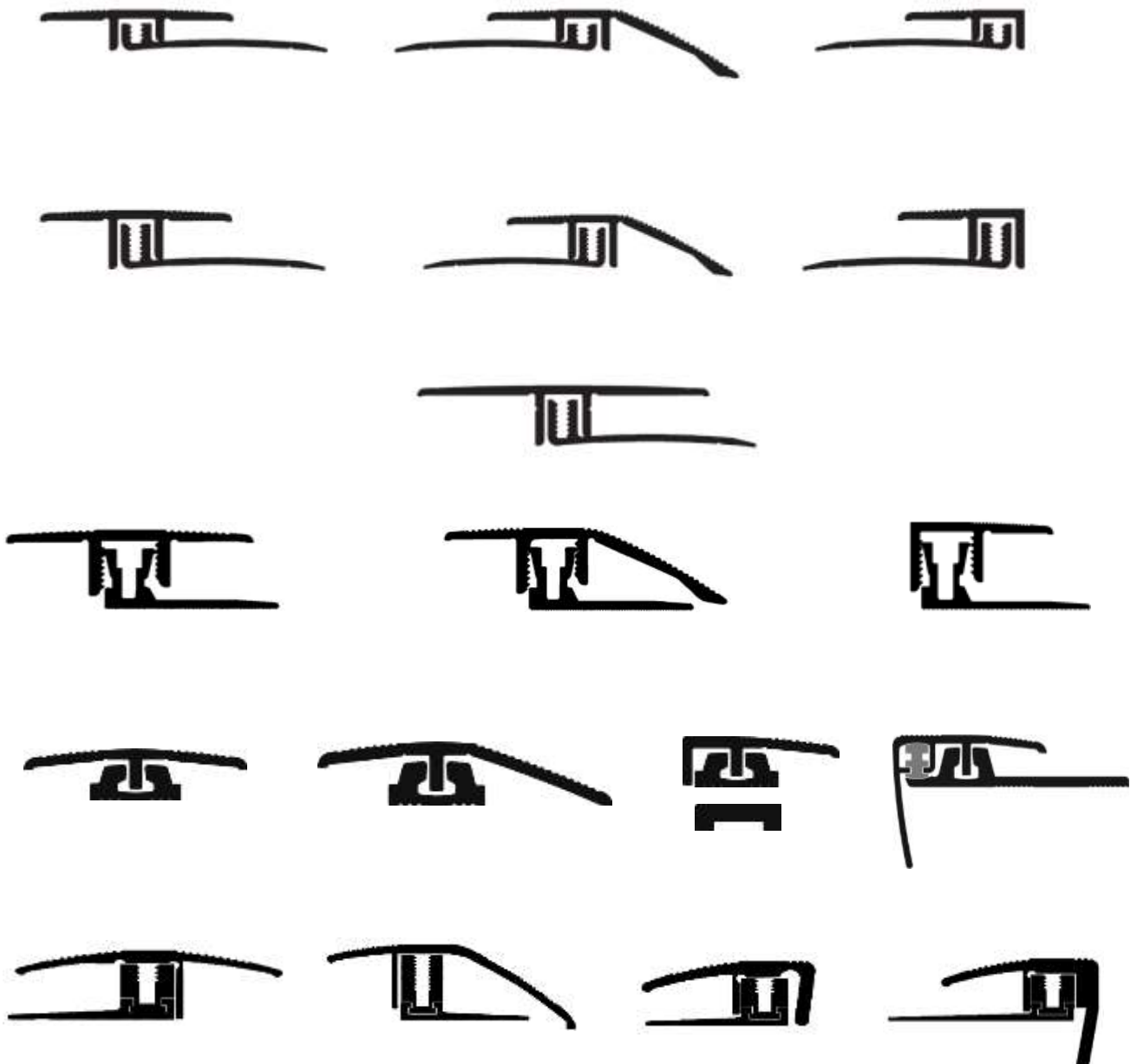

7. SYSTEMPROFILE FÜR 4-24mm BELÄGE/ 7. PROFILES FOR 4-24mm FLOORINGS

MINI-APL-System 5 - 9 mm, 2-teilig

MINI-APL-system 5 - 9 mm, 2 parts

306 **MINI-APL-Übergangsprofil**
5 - 9 mm, Aluminium, gebohrt,
mit 40 mm breitem Grundprofil

MINI-APL-edge 5 - 9 mm, aluminium,
drilled, with 40 mm wide basic profile

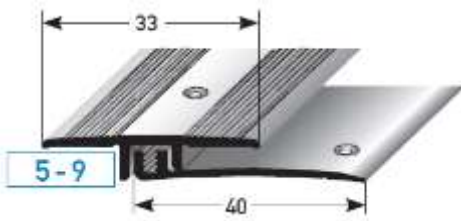

Zusätzliche Schrauben siehe Abschnitt 12.
Additional screws, see section 12.

SB-Pack incl. Schrauben + Dübel; VE 20 Stk.

self-service-pack with screws + dowels; à 20 pcs.

| Farbe/colour | L / l (m) | Art./ref. | €/Stk./pcs. |
|---|-----------|-----------|-------------|
| silberfarbig silver | 0,9 | 48776-0 | 17,72 |
| | 1,0 | 48778-4 | 19,68 |
| | 2,7 | 48780-7 | 53,12 |
| goldfarbig gold | 0,9 | 48782-1 | 17,88 |
| | 1,0 | 48784-5 | 19,84 |
| | 2,7 | 48786-9 | 53,60 |
| bronzef. hell bronze light | 0,9 | 48788-3 | 18,74 |
| | 1,0 | 48790-6 | 20,82 |
| | 2,7 | 48792-0 | 56,24 |
| bronzef. dunkel bronze dark | 0,9 | 48794-4 | 18,74 |
| | 1,0 | 48796-8 | 20,82 |
| | 2,7 | 48798-2 | 56,24 |
| gold hell gold light | 0,9 | 48800-2 | 17,88 |
| | 1,0 | 48802-6 | 19,84 |
| | 2,7 | 48804-0 | 53,60 |
| edelstahlfarbig stainless steel coloured | 0,9 | 48806-4 | 18,74 |
| | 1,0 | 48808-8 | 20,82 |
| | 2,7 | 48810-1 | 56,24 |

APL-System 7 - 15 mm, 2-teilig

APL-system 7 - 15 mm, 2 parts

255 **APL-Übergangsprofil**
7 - 15 mm, Aluminium, gebohrt,
mit 40 mm breitem Grundprofil

APL-edge 7 - 15 mm, aluminium,
drilled, with 40 mm wide basic profile

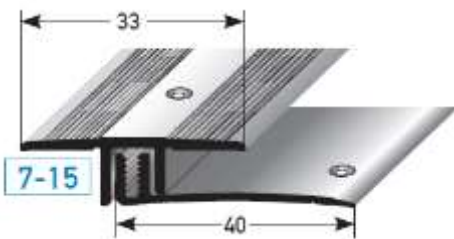

Zusätzliche Schrauben siehe Abschnitt 12.
Additional screws, see section 12.

Grundprofilerhöhung
siehe Seite 96

basic profile increase
see page 96

SB-Pack incl. Schrauben + Dübel; VE 20 Stk.

self-service-pack with screws + dowels; à 20 pcs.

| Farbe/colour | L / l (m) | Art./ref. | €/Stk./pcs. |
|---|-----------|-----------|-------------|
| silberfarbig silver | 0,9 | 45944-6 | 16,28 |
| | 1,0 | 45824-1 | 18,08 |
| | 2,7 | 45800-5 | 48,82 |
| goldfarbig gold | 0,9 | 45946-0 | 16,40 |
| | 1,0 | 45826-5 | 18,26 |
| | 2,7 | 45802-9 | 49,30 |
| bronzef. hell bronze light | 0,9 | 45950-7 | 17,30 |
| | 1,0 | 45830-2 | 19,22 |
| | 2,7 | 45806-7 | 51,92 |
| bronzef. dunkel bronze dark | 0,9 | 45952-1 | 17,30 |
| | 1,0 | 45832-6 | 19,22 |
| | 2,7 | 45808-1 | 51,92 |
| gold hell gold light | 0,9 | 45948-4 | 16,40 |
| | 1,0 | 45828-9 | 18,26 |
| | 2,7 | 45804-3 | 49,30 |
| edelstahlfarbig stainless steel coloured | 0,9 | 45964-4 | 17,30 |
| | 1,0 | 45844-9 | 19,22 |
| | 2,7 | 45820-3 | 51,92 |
| Buche beech | 0,9 | 45954-5 | 22,26 |
| | 1,0 | 45834-0 | 24,74 |
| | 2,7 | 45810-4 | 66,76 |
| Eiche oak | 0,9 | 45956-9 | 22,26 |
| | 1,0 | 45836-4 | 24,74 |
| | 2,7 | 45812-8 | 66,76 |
| Ahorn maple | 0,9 | 45958-3 | 22,26 |
| | 1,0 | 45838-8 | 24,74 |
| | 2,7 | 45814-2 | 66,76 |
| Kirschbaum cherry wood | 0,9 | 45960-6 | 22,26 |
| | 1,0 | 45840-1 | 24,74 |
| | 2,7 | 45816-6 | 66,76 |
| Eiche rustikal rustic oak | 0,9 | 45962-0 | 22,26 |
| | 1,0 | 45842-5 | 24,74 |
| | 2,7 | 45818-0 | 66,76 |

Holzdekorfolie/ wood decor

7. SYSTEMPROFILE FÜR 4-24mm BELÄGE/ 7. PROFILES FOR 4-24mm FLOORINGS

APL-System 7 - 15 mm, 2-teilig

APL-system 7 - 15 mm, 2 parts

499 **APL-Übergangprofil**
50 mm extrabreit, 7 - 15 mm,
Aluminium, gebohrt,
mit 40 mm breitem Grundprofil

APL-edge extra wide, 7 - 15 mm,
aluminium, drilled, with 40 mm wide
basic profile

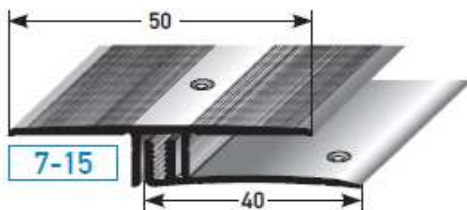

Zusätzliche Schrauben siehe Abschnitt 12.
Additional screws, see section 12.

SB-Pack incl. Schrauben + Dübel; VE 20 Stk.

self-service-pack with screws + dowels; à 20 pcs.

| Farbe/colour | L / l (m) | Art./ref. | €/Stk./pcs. |
|---|-----------|-----------|-------------|
| silberfarbig silver | 0,9 | 71356-2 | 17,12 |
| | 1,0 | 71358-6 | 19,00 |
| | 2,7 | 71360-9 | 51,32 |
| goldfarbig gold | 0,9 | 71362-3 | 17,48 |
| | 1,0 | 71364-7 | 19,40 |
| | 2,7 | 71366-1 | 52,36 |
| bronzef. hell bronze light | 0,9 | 71368-5 | 18,80 |
| | 1,0 | 71370-8 | 20,88 |
| | 2,7 | 71372-2 | 56,34 |
| bronzef. dunkel bronze dark | 0,9 | 71374-6 | 18,80 |
| | 1,0 | 71376-0 | 20,88 |
| | 2,7 | 71378-4 | 56,34 |
| gold hell gold light | 0,9 | 71380-7 | 17,48 |
| | 1,0 | 71382-1 | 19,40 |
| | 2,7 | 71384-5 | 52,36 |
| edelstahlfarbig stainless steel coloured | 0,9 | 71386-9 | 18,80 |
| | 1,0 | 71388-3 | 20,88 |
| | 2,7 | 71390-6 | 56,34 |

516 **20 mm breites MINI-APL-Grundprofil für 5 - 9 mm Beläge, Aluminium, gebohrt**

ohne Schrauben/ Dübel

20 mm wide MINI-APL-basic profile, for 5-9 mm flooring,
aluminium, drilled, without screws/ dowels

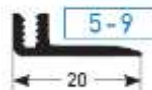

| L / l (m) | Art./ref. | €/Stk./pcs. |
|-----------|-----------|-------------|
| 0,9 | 71788-1 | 4,34 |
| 1,0 | 71790-4 | 4,82 |
| 2,7 | 71792-8 | 13,00 |

517 **20 mm breites APL-Grundprofil für 7 - 15 mm Beläge, Aluminium, gebohrt**

ohne Schrauben/ Dübel

20 mm wide APL-basic profile, for 7-15 mm flooring,
aluminium, drilled, without screws/ dowels



| L / l (m) | Art./ref. | €/Stk./pcs. |
|-----------|-----------|-------------|
| 0,9 | 71780-5 | 5,02 |
| 1,0 | 71782-9 | 5,58 |
| 2,7 | 71784-3 | 15,04 |

498 **Grundprofilerhöhung für APL- & SLP-System, PLA-3D, 2x gebohrt, inkl. Schrauben**

basic profile increase for APL and SLP
system, PLA-3D, 2x drilled, including
screws



| Höhe in mm height in mm | VE/unit | Art./ref. | €/Stk./pcs. |
|----------------------------|---------|-----------|-------------|
| 5 | 10 | 71796-6 | 1,86 |
| 8 | | 71798-0 | 2,10 |
| 11 | | 71800-0 | 2,32 |

7. SYSTEMPROFILE FÜR 4-24mm BELÄGE/ 7. PROFILES FOR 4-24mm FLOORINGS

MINI-APL-System 5 - 9 mm, 2-teilig

MINI-APL-system 5 - 9 mm, 2 parts

307 **MINI-APL-Höhenausgleichsprofil**
5 - 9 mm, Aluminium, gebohrt,
mit 40 mm breites Grundprofil

MINI-APL-height levelling 5 - 9 mm, aluminium,
drilled, with 40 mm wide basic profile

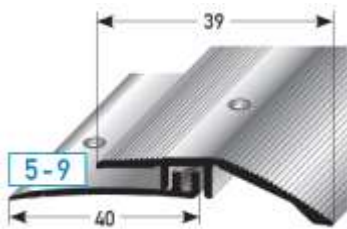

Zusätzliche Schrauben siehe Abschnitt 12.
Additional screws, see section 12.

| SB-Pack incl. Schrauben + Dübel; VE 20 Stk. | | | |
|---|-----------|-----------|-------------|
| self-service-pack with screws + dowels; à 20 pcs. | | | |
| Farbe/colour | L / l (m) | Art./ref. | €/Stk./pcs. |
| silberfarbig silver | 0,9 | 48856-9 | 20,20 |
| | 1,0 | 48858-3 | 22,44 |
| | 2,7 | 48860-6 | 60,62 |
| goldfarbig gold | 0,9 | 48862-0 | 20,24 |
| | 1,0 | 48864-4 | 22,52 |
| | 2,7 | 48866-8 | 60,80 |
| bronzef. hell bronze light | 0,9 | 48868-2 | 21,36 |
| | 1,0 | 48870-5 | 23,78 |
| | 2,7 | 48872-9 | 64,16 |
| bronzef. dunkel bronze dark | 0,9 | 48874-3 | 21,36 |
| | 1,0 | 48876-7 | 23,78 |
| | 2,7 | 48878-1 | 64,16 |
| gold hell gold light | 0,9 | 48880-4 | 20,24 |
| | 1,0 | 48882-8 | 22,52 |
| | 2,7 | 48884-2 | 60,80 |
| edelstahlfarbig stainless steel coloured | 0,9 | 48886-6 | 21,36 |
| | 1,0 | 48888-0 | 23,78 |
| | 2,7 | 48890-3 | 64,16 |

APL-System 7 - 15 mm, 2-teilig

APL-system 7 - 15 mm, 2 parts

256 **APL-Höhenausgleichsprofil**
7 - 15 mm, Aluminium, gebohrt,
mit 40 mm breitem Grundprofil

APL-height levelling 7 - 15 mm, aluminium,
drilled, with 40 mm wide basic profile

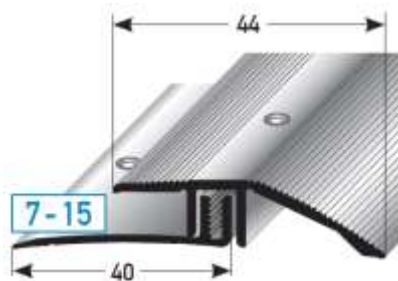

Zusätzliche Schrauben siehe Abschnitt 12.
Additional screws, see section 12.

| SB-Pack incl. Schrauben + Dübel; VE 20 Stk. | | | |
|---|-----------|-----------|-------------|
| self-service-pack with screws + dowels; à 20 pcs. | | | |
| Farbe/colour | L / l (m) | Art./ref. | €/Stk./pcs. |
| silberfarbig silver | 0,9 | 45966-8 | 18,76 |
| | 1,0 | 45872-2 | 20,84 |
| | 2,7 | 45848-7 | 56,26 |
| goldfarbig gold | 0,9 | 45968-2 | 18,84 |
| | 1,0 | 45874-6 | 20,90 |
| | 2,7 | 45850-0 | 56,48 |
| bronzef. hell bronze light | 0,9 | 45972-9 | 19,96 |
| | 1,0 | 45878-4 | 22,16 |
| | 2,7 | 45854-8 | 59,84 |
| bronzef. dunkel bronze dark | 0,9 | 45974-3 | 19,96 |
| | 1,0 | 45880-7 | 22,16 |
| | 2,7 | 45856-2 | 59,84 |
| gold hell gold light | 0,9 | 45970-5 | 18,84 |
| | 1,0 | 45876-0 | 20,90 |
| | 2,7 | 45852-4 | 56,48 |
| edelstahlfarbig stainless steel coloured | 0,9 | 45986-6 | 19,96 |
| | 1,0 | 45892-0 | 22,16 |
| | 2,7 | 45868-5 | 59,84 |

Holzdekorfolie/ wood decor

| | | | |
|------------------------------|-----|---------|-------|
| Buche beech | 0,9 | 45976-7 | 24,76 |
| | 1,0 | 45882-1 | 27,48 |
| | 2,7 | 45858-6 | 74,20 |
| Eiche oak | 0,9 | 45978-1 | 24,76 |
| | 1,0 | 45884-5 | 27,48 |
| | 2,7 | 45860-9 | 74,20 |
| Ahorn maple | 0,9 | 45980-4 | 24,76 |
| | 1,0 | 45886-9 | 27,48 |
| | 2,7 | 45862-3 | 74,20 |
| Kirschbaum cherry wood | 0,9 | 45982-8 | 24,76 |
| | 1,0 | 45888-3 | 27,48 |
| | 2,7 | 45864-7 | 74,20 |
| Eiche rustikal rustic oak | 0,9 | 45984-2 | 24,76 |
| | 1,0 | 45890-6 | 27,48 |
| | 2,7 | 45866-1 | 74,20 |

Grundprofilerrhöhung
siehe Seite 96

basic profile increase
see page 96

7. SYSTEMPROFILE FÜR 4-24mm BELÄGE/ 7. PROFILES FOR 4-24mm FLOORINGS

MINI-APL-System 5 - 9 mm, 2-teilig
MINI-APL-system 5 - 9 mm, 2 parts

308 MINI-APL-Abschlussprofil
5 - 9 mm, Aluminium, gebohrt,
mit 40 mm breites Grundprofil

MINI-APL-end 5 - 9 mm, aluminium, drilled,
with 40 mm wide basic profile

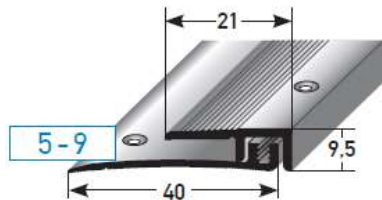

Zusätzliche Schrauben siehe Abschnitt 12.
Additional screws, see section 12.

| SB-Pack incl. Schrauben + Dübel; VE 20 Stk. | | | |
|---|-----------|---------|-------------|
| self-service-pack with screws + dowels; à 20 pcs. | | | |
| Farbe/colour | L / l (m) | | €/Stk./pcs. |
| silberfarbig silver | 0,9 | 48936-8 | 16,46 |
| | 1,0 | 48938-2 | 18,28 |
| | 2,7 | 48940-5 | 49,40 |
| goldfarbig gold | 0,9 | 48942-9 | 16,56 |
| | 1,0 | 48944-3 | 18,38 |
| | 2,7 | 48946-7 | 49,66 |
| bronzef. hell bronze light | 0,9 | 48948-1 | 17,48 |
| | 1,0 | 48950-4 | 19,40 |
| | 2,7 | 48952-8 | 52,42 |
| bronzef. dunkel bronze dark | 0,9 | 48954-2 | 17,48 |
| | 1,0 | 48956-6 | 19,40 |
| | 2,7 | 48958-0 | 52,42 |
| gold hell gold light | 0,9 | 48960-3 | 16,56 |
| | 1,0 | 48962-7 | 18,38 |
| | 2,7 | 48964-1 | 49,66 |
| edelstahlfarbig stainless steel coloured | 0,9 | 48966-5 | 17,48 |
| | 1,0 | 48968-9 | 19,40 |
| | 2,7 | 48970-2 | 52,42 |

APL-System 7 - 15 mm, 2-teilig
APL-system 7 - 15 mm, 2 parts

257 APL-Abschlussprofil
7 - 15 mm, Aluminium, gebohrt,
mit 40 mm breites Grundprofil

APL-end 7 - 15 mm, aluminium, drilled,
with 40 mm wide basic profile

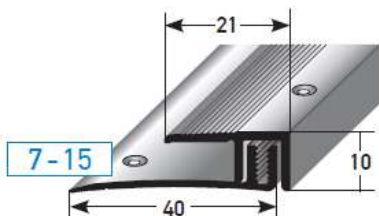

Zusätzliche Schrauben siehe Abschnitt 12.
Additional screws, see section 12.

| SB-Pack incl. Schrauben + Dübel; VE 20 Stk. | | | |
|---|-----------|-----------|-------------|
| self-service-pack with screws + dowels; à 20 pcs. | | | |
| Farbe/colour | L / l (m) | Art./ref. | €/Stk./pcs. |
| silberfarbig silver | 0,9 | 45988-0 | 15,04 |
| | 1,0 | 45920-0 | 16,72 |
| | 2,7 | 45896-8 | 45,06 |
| goldfarbig gold | 0,9 | 45990-3 | 15,12 |
| | 1,0 | 45922-4 | 16,80 |
| | 2,7 | 45898-2 | 45,36 |
| bronzef. hell bronze light | 0,9 | 45994-1 | 16,02 |
| | 1,0 | 45926-2 | 17,82 |
| | 2,7 | 45902-6 | 48,08 |
| bronzef. dunkel bronze dark | 0,9 | 45996-5 | 16,02 |
| | 1,0 | 45928-6 | 17,82 |
| | 2,7 | 45904-0 | 48,08 |
| gold hell gold light | 0,9 | 45992-7 | 15,12 |
| | 1,0 | 45924-8 | 16,80 |
| | 2,7 | 45900-2 | 45,36 |
| edelstahlfarbig stainless steel coloured | 0,9 | 46008-4 | 16,02 |
| | 1,0 | 45940-8 | 17,82 |
| | 2,7 | 45916-3 | 48,08 |
| Buche beech | 0,9 | 45998-9 | 20,98 |
| | 1,0 | 45930-9 | 23,28 |
| | 2,7 | 45906-4 | 62,94 |
| Eiche oak | 0,9 | 46000-8 | 20,98 |
| | 1,0 | 45932-3 | 23,28 |
| | 2,7 | 45908-8 | 62,94 |
| Ahorn maple | 0,9 | 46002-2 | 20,98 |
| | 1,0 | 45934-7 | 23,28 |
| | 2,7 | 45910-1 | 62,94 |
| Kirschbaum cherry wood | 0,9 | 46004-6 | 20,98 |
| | 1,0 | 45936-1 | 23,28 |
| | 2,7 | 45912-5 | 62,94 |
| Eiche rustikal rustic oak | 0,9 | 46006-0 | 20,98 |
| | 1,0 | 45938-5 | 23,28 |
| | 2,7 | 45914-9 | 62,94 |

Holzdekorfolie/ wood decor

7. SYSTEMPROFILE FÜR 4-24mm BELÄGE/ 7. PROFILES FOR 4-24mm FLOORINGS

MINI-APL-KLICK-System 4-7 mm, 2-teilig

MINI-APL-CLICK-system 4-7 mm, 2-teilig/ 2 parts

447 MINI-APL-Klick-Übergangprofil

4 - 7 mm, zum Klicken,
Aluminium

MINI-APL-click-edge 4 - 7 mm, to click,
aluminium

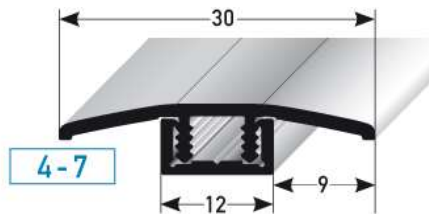

| SB-Pack incl. Schrauben + Dübel; VE 20 Stk. | | | |
|--|-----------|-----------|-------------|
| self-service-pack with screws + dowels; à 20 pcs. | | | |
| Farbe/colour | L / l (m) | Art./ref. | €/Stk./pcs. |
| silberfarbig silver | 0,9 | 68396-4 | 15,10 |
| | 1,0 | 68398-8 | 16,78 |
| | 2,7 | 68400-8 | 45,34 |
| goldfarbig gold | 0,9 | 68402-2 | 15,52 |
| | 1,0 | 68404-6 | 17,24 |
| | 2,7 | 68406-0 | 46,60 |
| bronzef. hell bronze light | 0,9 | 68408-4 | 16,86 |
| | 1,0 | 68410-7 | 18,76 |
| | 2,7 | 68412-1 | 50,66 |
| bronzef. dunkel bronze dark | 0,9 | 68414-5 | 16,86 |
| | 1,0 | 68416-9 | 18,76 |
| | 2,7 | 68418-3 | 50,66 |
| gold hell gold light | 0,9 | 68420-6 | 15,52 |
| | 1,0 | 68422-0 | 17,24 |
| | 2,7 | 68424-4 | 46,60 |
| edelstahlfarbig/ AL-INOX stainless steel coloured | 0,9 | 68426-8 | 16,86 |
| | 1,0 | 68428-2 | 18,76 |
| | 2,7 | 68430-5 | 50,66 |

APL-KLICK-System 7-10 mm, 2-teilig

APL-CLICK-system 7-10 mm, 2-teilig/ 2 parts

272 APL-Klick-Übergangprofil

7 - 10 mm, zum Klicken,
Aluminium

APL-click-edge 7 - 10 mm, to click,
aluminium

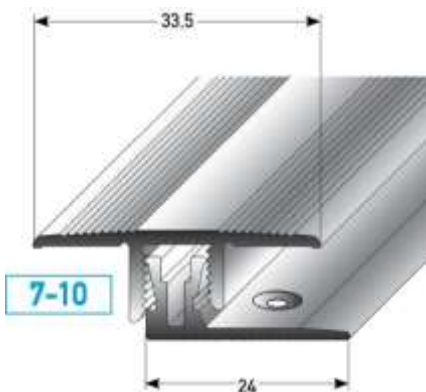

Für 7-10 mm-Beläge + 2 mm Dämmung
for 7-10 mm coverings + 2 mm insulation

| SB-Pack incl. Schrauben + Dübel; VE 20 Stk. | | | |
|--|-----------|-----------|-------------|
| self-service-pack with screws + dowels; à 20 pcs. | | | |
| Farbe/colour | L / l (m) | Art./ref. | €/Stk./pcs. |
| silberfarbig silver | 0,9 | 48300-7 | 16,16 |
| | 1,0 | 48302-1 | 17,96 |
| | 2,7 | 48304-5 | 48,46 |
| goldfarbig gold | 0,9 | 48306-9 | 16,30 |
| | 1,0 | 48308-3 | 18,10 |
| | 2,7 | 48310-6 | 48,90 |
| bronzef. hell bronze light | 0,9 | 48312-0 | 17,16 |
| | 1,0 | 48314-4 | 19,10 |
| | 2,7 | 48316-8 | 51,52 |
| bronzef. dunkel bronze dark | 0,9 | 48318-2 | 17,16 |
| | 1,0 | 48320-5 | 19,10 |
| | 2,7 | 48322-9 | 51,52 |
| gold hell gold light | 0,9 | 48324-3 | 16,30 |
| | 1,0 | 48326-7 | 18,10 |
| | 2,7 | 48328-1 | 48,90 |
| edelstahlfarbig/ AL-INOX stainless steel coloured | 0,9 | 48330-4 | 17,16 |
| | 1,0 | 48332-8 | 19,10 |
| | 2,7 | 48334-2 | 51,52 |
| Buche beech | 0,9 | 48336-6 | 22,14 |
| | 1,0 | 48338-0 | 24,58 |
| | 2,7 | 48340-3 | 66,42 |
| Eiche oak | 0,9 | 48342-7 | 22,14 |
| | 1,0 | 48344-1 | 24,58 |
| | 2,7 | 48346-5 | 66,42 |
| Ahorn maple | 0,9 | 48348-9 | 22,14 |
| | 1,0 | 48350-2 | 24,58 |
| | 2,7 | 48352-6 | 66,42 |
| Kirschbaum cherry wood | 0,9 | 48354-0 | 22,14 |
| | 1,0 | 48356-4 | 24,58 |
| | 2,7 | 48358-8 | 66,42 |
| Eiche rustikal rustic oak | 0,9 | 48360-1 | 22,14 |
| | 1,0 | 48362-5 | 24,58 |
| | 2,7 | 48364-9 | 66,42 |

Holzdekorfolie/ wood decor

7. SYSTEMPROFILE FÜR 4-24mm BELÄGE/ 7. PROFILES FOR 4-24mm FLOORINGS

APL-KLICK-System 11-15 mm, 2-teilig

APL-CLICK-system 11-15 mm, 2 parts

273

APL-Klick-Übergangprofil

11 - 15 mm, zum Klicken,
Aluminium

APL-click-edge 11 - 15 mm, to click,
aluminium

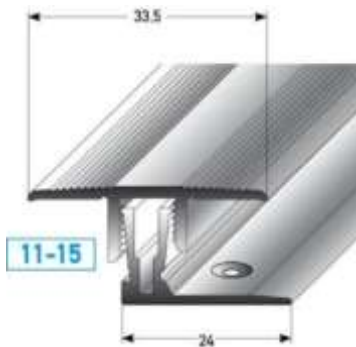

Für 11-15 mm-Beläge + 2 mm Dämmung
for 11-15 mm coverings + 2 mm insulation

Holzdekorfolie/ wood decor

| SB-Pack incl. Schrauben + Dübel; VE 20 Stk. | | | |
|--|-----------|-----------|-------------|
| self-service-pack with screws + dowels; à 20 pcs. | | | |
| Farbe/colour | L / l (m) | Art./ref. | €/Stk./pcs. |
| silberfarbig silver | 0,9 | 48378-6 | 17,16 |
| | 1,0 | 48380-9 | 19,10 |
| | 2,7 | 48382-3 | 51,52 |
| goldfarbig gold | 0,9 | 48384-7 | 17,32 |
| | 1,0 | 48386-1 | 19,24 |
| | 2,7 | 48388-5 | 51,98 |
| bronzef. hell bronze light | 0,9 | 48390-8 | 18,18 |
| | 1,0 | 48392-2 | 20,22 |
| | 2,7 | 48394-6 | 54,62 |
| bronzef. dunkel bronze dark | 0,9 | 48396-0 | 18,18 |
| | 1,0 | 48398-4 | 20,22 |
| | 2,7 | 48400-4 | 54,62 |
| gold hell gold light | 0,9 | 48402-8 | 17,32 |
| | 1,0 | 48404-2 | 19,24 |
| | 2,7 | 48406-6 | 51,98 |
| edelstahlfarbig/ AL-INOX stainless steel coloured | 0,9 | 48408-0 | 18,18 |
| | 1,0 | 48410-3 | 20,22 |
| | 2,7 | 48412-7 | 54,62 |
| Buche beech | 0,9 | 48414-1 | 23,18 |
| | 1,0 | 48416-5 | 25,74 |
| | 2,7 | 48418-9 | 69,50 |
| Eiche oak | 0,9 | 48420-2 | 23,18 |
| | 1,0 | 48422-6 | 25,74 |
| | 2,7 | 48424-0 | 69,50 |
| Ahorn maple | 0,9 | 48426-4 | 23,18 |
| | 1,0 | 48428-8 | 25,74 |
| | 2,7 | 48430-1 | 69,50 |
| Kirschbaum cherry wood | 0,9 | 48432-5 | 23,18 |
| | 1,0 | 48434-9 | 25,74 |
| | 2,7 | 48436-3 | 69,50 |
| Eiche rustikal rustic oak | 0,9 | 48438-7 | 23,18 |
| | 1,0 | 48440-0 | 25,74 |
| | 2,7 | 48442-4 | 69,50 |

APL-KLICK-System 15-24 mm, 2-teilig

APL-CLICK-system 15-24 mm, 2 parts

448

APL-Klick-Übergangprofil

15 - 24 mm, zum Klicken,
Aluminium

APL-click-edge 15 - 24 mm, to click,
aluminium

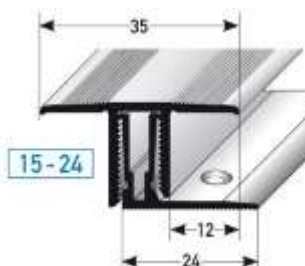

Für 15-24 mm-Beläge + 2 mm Dämmung
for 15-24 mm coverings + 2 mm insulation

| SB-Pack incl. Schrauben + Dübel; VE 20 Stk. | | | |
|--|-----------|-----------|-------------|
| self-service-pack with screws + dowels; à 20 pcs. | | | |
| Farbe/colour | L / l (m) | Art./ref. | €/Stk./pcs. |
| silberfarbig silver | 0,9 | 68440-4 | 21,40 |
| | 1,0 | 68442-8 | 23,80 |
| | 2,7 | 68444-2 | 64,24 |
| goldfarbig gold | 0,9 | 68446-6 | 21,54 |
| | 1,0 | 68448-0 | 23,94 |
| | 2,7 | 68450-3 | 64,64 |
| bronzef. hell bronze light | 0,9 | 68452-7 | 22,72 |
| | 1,0 | 68454-1 | 25,26 |
| | 2,7 | 68456-5 | 68,18 |
| bronzef. dunkel bronze dark | 0,9 | 68458-9 | 22,72 |
| | 1,0 | 68460-2 | 25,26 |
| | 2,7 | 68462-6 | 68,18 |
| gold hell gold light | 0,9 | 68464-0 | 21,54 |
| | 1,0 | 68466-4 | 23,94 |
| | 2,7 | 68468-8 | 64,64 |
| edelstahlfarbig/ AL-INOX stainless steel coloured | 0,9 | 68470-1 | 22,72 |
| | 1,0 | 68472-5 | 25,26 |
| | 2,7 | 68474-9 | 68,18 |

7. SYSTEMPROFILE FÜR 4-24mm BELÄGE/ 7. PROFILES FOR 4-24mm FLOORINGS

MINI-APL-KLICK-System 4-7 mm, 2-teilig

MINI-APL-CLICK-system 4-7 mm, 2 parts

449

**MINI-APL-Klick-
Höhenausgleichsprofil
4 - 7 mm, zum Klicken, Aluminium**

MINI-APL-click-height levelling 4 - 7 mm,
to click, aluminium

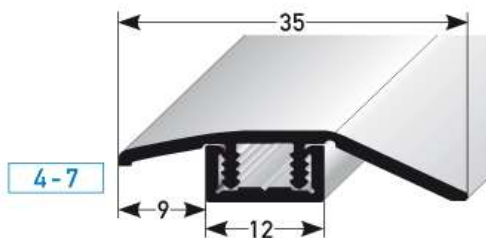

| SB-Pack incl. Schrauben + Dübel; VE 20 Stk. self-service-pack with screws + dowels; à 20 pcs. | | | |
|--|-----------|-----------|-------------|
| Farbe/colour | L / l (m) | Art./ref. | €/Stk./pcs. |
| silberfarbig silver | 0,9 | 68484-8 | 15,72 |
| | 1,0 | 68486-2 | 17,50 |
| | 2,7 | 68488-6 | 47,18 |
| goldfarbig gold | 0,9 | 68490-9 | 16,18 |
| | 1,0 | 68492-3 | 17,96 |
| | 2,7 | 68494-7 | 48,48 |
| bronzef. hell bronze light | 0,9 | 68496-1 | 17,60 |
| | 1,0 | 68498-5 | 19,58 |
| | 2,7 | 68500-5 | 52,82 |
| bronzef. dunkel bronze dark | 0,9 | 68502-9 | 17,60 |
| | 1,0 | 68504-3 | 19,58 |
| | 2,7 | 68506-7 | 52,82 |
| gold hell gold light | 0,9 | 68508-1 | 16,18 |
| | 1,0 | 68510-4 | 17,96 |
| | 2,7 | 68512-8 | 48,48 |
| edelstahlfarbig/ AL-INOX stainless steel coloured | 0,9 | 68514-2 | 17,60 |
| | 1,0 | 68516-6 | 19,58 |
| | 2,7 | 68518-0 | 52,82 |

APL-KLICK-System 7-10 mm, 2-teilig

APL-CLICK-system 7-10 mm, 2 parts

274

**APL-Klick-
Höhenausgleichsprofil
7 - 10 mm, zum Klicken, Aluminium**

APL-click-height levelling 7 - 10 mm, to click,
aluminium

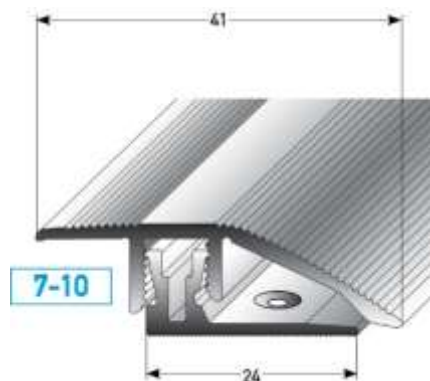

| SB-Pack incl. Schrauben + Dübel; VE 20 Stk. self-service-pack with screws + dowels; à 20 pcs. | | | |
|--|-----------|-----------|-------------|
| Farbe/colour | L / l (m) | Art./ref. | €/Stk./pcs. |
| silberfarbig silver | 0,9 | 48458-5 | 18,68 |
| | 1,0 | 48460-8 | 20,72 |
| | 2,7 | 48462-2 | 55,96 |
| goldfarbig gold | 0,9 | 48464-6 | 18,70 |
| | 1,0 | 48466-0 | 20,78 |
| | 2,7 | 48468-4 | 56,08 |
| bronzef. hell bronze light | 0,9 | 48470-7 | 19,82 |
| | 1,0 | 48472-1 | 22,04 |
| | 2,7 | 48474-5 | 59,48 |
| bronzef. dunkel bronze dark | 0,9 | 48476-9 | 19,82 |
| | 1,0 | 48478-3 | 22,04 |
| | 2,7 | 48480-6 | 59,48 |
| gold hell gold light | 0,9 | 48482-0 | 18,70 |
| | 1,0 | 48484-4 | 20,78 |
| | 2,7 | 48486-8 | 56,08 |
| edelstahlfarbig/ AL-INOX stainless steel coloured | 0,9 | 48488-2 | 19,82 |
| | 1,0 | 48490-5 | 22,04 |
| | 2,7 | 48492-9 | 59,48 |
| Buche beech | 0,9 | 48494-3 | 24,58 |
| | 1,0 | 48496-7 | 27,36 |
| | 2,7 | 48498-1 | 73,80 |
| Eiche oak | 0,9 | 48500-1 | 24,58 |
| | 1,0 | 48502-5 | 27,36 |
| | 2,7 | 48504-9 | 73,80 |
| Ahorn maple | 0,9 | 48506-3 | 24,58 |
| | 1,0 | 48508-7 | 27,36 |
| | 2,7 | 48510-0 | 73,80 |
| Kirschbaum cherry wood | 0,9 | 48512-4 | 24,58 |
| | 1,0 | 48514-8 | 27,36 |
| | 2,7 | 48516-2 | 73,80 |
| Eiche rustikal rustic oak | 0,9 | 48518-6 | 24,58 |
| | 1,0 | 48520-9 | 27,36 |
| | 2,7 | 48522-3 | 73,80 |

Holzdekorfolie/ wood decor

Für 7-10 mm-Beläge + 2 mm Dämmung
for 7-10 mm coverings + 2 mm insulation

7. SYSTEMPROFILE FÜR 4-24mm BELÄGE/7. PROFILES FOR 4-24mm FLOORINGS

APL-KLICK-System 11-15 mm, 2-teilig

APL-CLICK-system 11-15 mm, 2 parts

275

APL-Klick- Höhenausgleichsprofil

11 - 15 mm, zum Klicken,
Aluminium

APL-click-height levelling 11 - 15 mm, to click,
aluminium

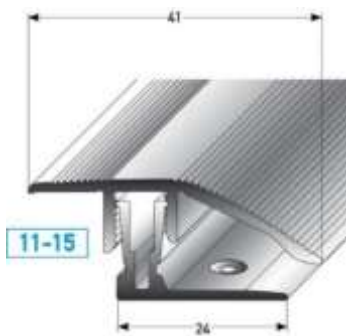

Für 11-15 mm-Beläge + 2 mm Dämmung
for 11-15 mm coverings + 2 mm insulation

SB-Pack incl. Schrauben + Dübel; VE 20 Stk.

self-service-pack with screws + dowels; à 20 pcs.

| Farbe/colour | L / l (m) | Art./ref. | €/Stk./pcs. |
|--|-----------|-----------|-------------|
| silberfarbig silver | 0,9 | 48536-0 | 19,68 |
| | 1,0 | 48538-4 | 21,86 |
| | 2,7 | 48540-7 | 59,04 |
| goldfarbig gold | 0,9 | 48542-1 | 19,70 |
| | 1,0 | 48544-5 | 21,90 |
| | 2,7 | 48546-9 | 59,16 |
| bronzef. hell bronze light | 0,9 | 48548-3 | 20,84 |
| | 1,0 | 48550-6 | 23,18 |
| | 2,7 | 48552-0 | 62,56 |
| bronzef. dunkel bronze dark | 0,9 | 48554-4 | 20,84 |
| | 1,0 | 48556-8 | 23,18 |
| | 2,7 | 48558-2 | 62,56 |
| gold hell gold light | 0,9 | 48560-5 | 19,70 |
| | 1,0 | 48562-9 | 21,90 |
| | 2,7 | 48564-3 | 59,16 |
| edelstahlfarbig/ AL-INOX stainless steel coloured | 0,9 | 48566-7 | 20,84 |
| | 1,0 | 48568-1 | 23,18 |
| | 2,7 | 48570-4 | 62,56 |
| Buche beech | 0,9 | 48572-8 | 25,78 |
| | 1,0 | 48574-2 | 28,64 |
| | 2,7 | 48576-6 | 77,26 |
| Eiche oak | 0,9 | 48578-0 | 25,78 |
| | 1,0 | 48580-3 | 28,64 |
| | 2,7 | 48582-7 | 77,26 |
| Ahorn maple | 0,9 | 48584-1 | 25,78 |
| | 1,0 | 48586-5 | 28,64 |
| | 2,7 | 48588-9 | 77,26 |
| Kirschbaum cherry wood | 0,9 | 48590-2 | 25,78 |
| | 1,0 | 48592-6 | 28,64 |
| | 2,7 | 48594-0 | 77,26 |
| Eiche rustikal rustic oak | 0,9 | 48596-4 | 25,78 |
| | 1,0 | 48598-8 | 28,64 |
| | 2,7 | 48600-8 | 77,26 |

Holzdekorfolie/ wood decor

APL-KLICK-System 15-24 mm, 2-teilig

APL-CLICK-system 15-24 mm, 2 parts

450

APL-Klick- Höhenausgleichsprofil

15 - 24 mm, zum Klicken, Aluminium

APL-click-height levelling 15 - 24 mm, to click,
aluminium

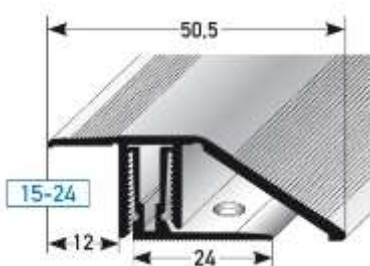

Für 15-24 mm-Beläge + 2 mm Dämmung
for 15-24 mm coverings + 2 mm insulation

SB-Pack incl. Schrauben + Dübel; VE 20 Stk.

self-service-pack with screws + dowels; à 20 pcs.

| Farbe/colour | L / l (m) | Art./ref. | €/Stk./pcs. |
|--|-----------|-----------|-------------|
| silberfarbig silver | 0,9 | 68528-9 | 26,24 |
| | 1,0 | 68530-2 | 29,18 |
| | 2,7 | 68532-6 | 78,76 |
| goldfarbig gold | 0,9 | 68534-0 | 26,28 |
| | 1,0 | 68536-4 | 29,22 |
| | 2,7 | 68538-8 | 78,88 |
| bronzef. hell bronze light | 0,9 | 68540-1 | 27,88 |
| | 1,0 | 68542-5 | 30,96 |
| | 2,7 | 68544-9 | 83,64 |
| bronzef. dunkel bronze dark | 0,9 | 68546-3 | 27,88 |
| | 1,0 | 68548-7 | 30,96 |
| | 2,7 | 68550-0 | 83,64 |
| gold hell gold light | 0,9 | 68552-4 | 26,28 |
| | 1,0 | 68554-8 | 29,22 |
| | 2,7 | 68556-2 | 78,88 |
| edelstahlfarbig/ AL-INOX stainless steel coloured | 0,9 | 68558-6 | 27,88 |
| | 1,0 | 68560-9 | 30,96 |
| | 2,7 | 68562-3 | 83,64 |

7. SYSTEMPROFILE FÜR 4-24mm BELÄGE/ 7. PROFILES FOR 4-24mm FLOORINGS

MINI-APL-KLICK-System 4-7 mm, 2-teilig

MINI-APL-CLICK-system 4-7 mm, 2 parts

451

MINI-APL-Klick- Abschlussprofil

4 - 7 mm, zum Klicken, Aluminium

MINI-APL-click-end 4 - 7 mm, to click, aluminium

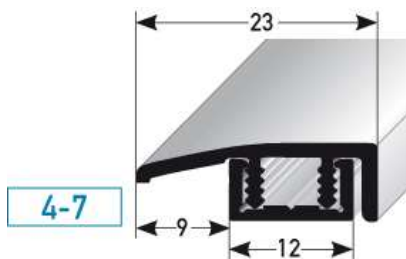

| SB-Pack incl. Schrauben + Dübel; VE 20 Stk. | | | |
|--|-----------|-----------|-------------|
| self-service-pack with screws + dowels; à 20 pcs. | | | |
| Farbe/colour | L / l (m) | Art./ref. | €/Stk./pcs. |
| silberfarbig silver | 0,9 | 68572-2 | 15,02 |
| | 1,0 | 68574-6 | 16,66 |
| | 2,7 | 68576-0 | 44,98 |
| goldfarbig gold | 0,9 | 68578-4 | 15,40 |
| | 1,0 | 68580-7 | 17,12 |
| | 2,7 | 68582-1 | 46,20 |
| bronzef. hell bronze light | 0,9 | 68584-5 | 16,74 |
| | 1,0 | 68586-9 | 18,60 |
| | 2,7 | 68588-3 | 50,20 |
| bronzef. dunkel bronze dark | 0,9 | 68590-6 | 16,74 |
| | 1,0 | 68592-0 | 18,60 |
| | 2,7 | 68594-4 | 50,20 |
| gold hell gold light | 0,9 | 68596-8 | 15,40 |
| | 1,0 | 68598-2 | 17,12 |
| | 2,7 | 68600-2 | 46,20 |
| edelstahlfarbig/ AL-INOX stainless steel coloured | 0,9 | 68602-6 | 16,74 |
| | 1,0 | 68604-0 | 18,60 |
| | 2,7 | 68606-4 | 50,20 |

APL-KLICK-System 7-10 mm, 2-teilig

APL-CLICK-system 7-10 mm, 2 parts

276

APL-Klick- Abschlussprofil

7 - 10 mm, zum Klicken,
Aluminium

APL-click-end 7 - 10 mm, to click, aluminium

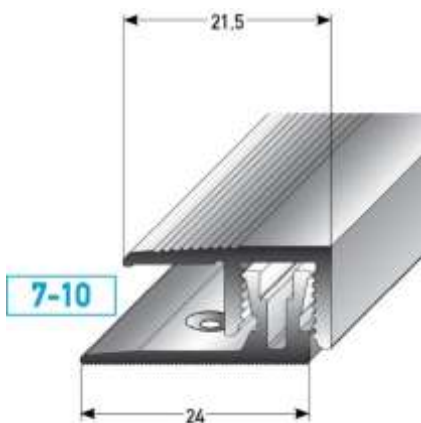

Für 7-10 mm-Beläge + 2 mm Dämmung
for 7-10 mm coverings + 2 mm insulation

| SB-Pack incl. Schrauben + Dübel; VE 20 Stk. | | | |
|--|-----------|-----------|-------------|
| self-service-pack with screws + dowels; à 20 pcs. | | | |
| Farbe/colour | L / l (m) | Art./ref. | €/Stk./pcs. |
| silberfarbig silver | 0,9 | 48616-9 | 14,88 |
| | 1,0 | 48618-3 | 16,56 |
| | 2,7 | 48620-6 | 44,62 |
| goldfarbig gold | 0,9 | 48622-0 | 15,02 |
| | 1,0 | 48624-4 | 16,64 |
| | 2,7 | 48626-8 | 44,96 |
| bronzef. hell bronze light | 0,9 | 48628-2 | 15,88 |
| | 1,0 | 48630-5 | 17,66 |
| | 2,7 | 48632-9 | 47,68 |
| bronzef. dunkel bronze dark | 0,9 | 48634-3 | 15,88 |
| | 1,0 | 48636-7 | 17,66 |
| | 2,7 | 48638-1 | 47,68 |
| gold hell gold light | 0,9 | 48640-4 | 15,02 |
| | 1,0 | 48642-8 | 16,64 |
| | 2,7 | 48644-2 | 44,96 |
| edelstahlfarbig/ AL-INOX stainless steel coloured | 0,9 | 48646-6 | 15,88 |
| | 1,0 | 48648-0 | 17,66 |
| | 2,7 | 48650-3 | 47,68 |
| Buche beech | 0,9 | 48652-7 | 20,84 |
| | 1,0 | 48654-1 | 23,18 |
| | 2,7 | 48656-5 | 62,56 |
| Eiche oak | 0,9 | 48658-9 | 20,84 |
| | 1,0 | 48660-2 | 23,18 |
| | 2,7 | 48662-6 | 62,56 |
| Ahorn maple | 0,9 | 48664-0 | 20,84 |
| | 1,0 | 48666-4 | 23,18 |
| | 2,7 | 48668-8 | 62,56 |
| Kirschaum cherry wood | 0,9 | 48670-1 | 20,84 |
| | 1,0 | 48672-5 | 23,18 |
| | 2,7 | 48674-9 | 62,56 |
| Eiche rustikal rustic oak | 0,9 | 48676-3 | 20,84 |
| | 1,0 | 48678-7 | 23,18 |
| | 2,7 | 48680-0 | 62,56 |

Holzdekorfolie/ wood decor

7. SYSTEMPROFILE FÜR 4-24mm BELÄGE/ 7. PROFILES FOR 4-24mm FLOORINGS

APL-KLICK-System 11-15 mm, 2-teilig

APL-CLICK-system 11-15 mm, 2 parts

277 APL-Klick-Abschlussprofil
11 - 15 mm, zum Klicken,
Aluminium

APL-click-end 11 - 15 mm, to click, aluminium

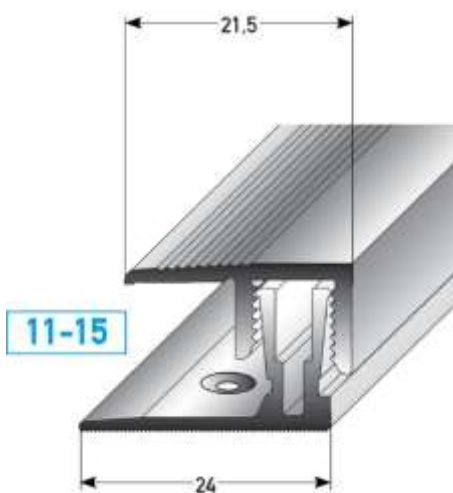

Für 11-15 mm-Beläge + 2 mm Dämmung
 for 11-15 mm coverings + 2 mm insulation

| SB-Pack incl. Schrauben + Dübel; VE 20 Stk. | | | |
|--|-----------|-----------|-------------|
| self-service-pack with screws + dowels; à 20 pcs. | | | |
| Farbe/colour | L / l (m) | Art./ref. | €/Stk./pcs. |
| silberfarbig silver | 0,9 | 48694-7 | 15,92 |
| | 1,0 | 48696-1 | 17,68 |
| | 2,7 | 48698-5 | 47,72 |
| goldfarbig gold | 0,9 | 48700-5 | 16,02 |
| | 1,0 | 48702-9 | 17,82 |
| | 2,7 | 48704-3 | 48,06 |
| bronzef. hell bronze light | 0,9 | 48706-7 | 16,90 |
| | 1,0 | 48708-1 | 18,80 |
| | 2,7 | 48710-4 | 50,76 |
| bronzef. dunkel bronze dark | 0,9 | 48712-8 | 16,90 |
| | 1,0 | 48714-2 | 18,80 |
| | 2,7 | 48716-6 | 50,76 |
| gold hell gold light | 0,9 | 48718-0 | 16,02 |
| | 1,0 | 48720-3 | 17,82 |
| | 2,7 | 48722-7 | 48,06 |
| edelstahlfarbig/ AL-INOX stainless steel coloured | 0,9 | 48724-1 | 16,90 |
| | 1,0 | 48726-5 | 18,80 |
| | 2,7 | 48728-9 | 50,76 |
| Buche beech | 0,9 | 48730-2 | 21,88 |
| | 1,0 | 48732-6 | 24,34 |
| | 2,7 | 48734-0 | 65,66 |
| Eiche oak | 0,9 | 48736-4 | 21,88 |
| | 1,0 | 48738-8 | 24,34 |
| | 2,7 | 48740-1 | 65,66 |
| Ahorn maple | 0,9 | 48742-5 | 21,88 |
| | 1,0 | 48744-9 | 24,34 |
| | 2,7 | 48746-3 | 65,66 |
| Kirschbaum cherry wood | 0,9 | 48748-7 | 21,88 |
| | 1,0 | 48750-0 | 24,34 |
| | 2,7 | 48752-4 | 65,66 |
| Eiche rustikal rustic oak | 0,9 | 48754-8 | 21,88 |
| | 1,0 | 48756-2 | 24,34 |
| | 2,7 | 48758-6 | 65,66 |

Holzdekorfolie/ wood decor

SYSTEMPROFILE FÜR 4-24mm BELÄGE/ PROFILES FOR 4-24mm FLOORINGS

SKD - SYSTEM FÜR KLICKDESIGN-BELÄGE 4 - 7 mm, flexibel, 2-teilig

SKD - system for click design flooring 4-7 mm, flexible, 2 parts

SB-Pack incl. Schrauben + Dübel; VE 20 Stk.

self-service-pack with screws + dowels; à 20 pcs.

| Farbe/colour | L / l (m) | Art./ref. | €/Stk./pcs. |
|--------------|-----------|-----------|-------------|
|--------------|-----------|-----------|-------------|

315 SKD-Übergangprofil für Klickdesign-Beläge für Höhe 4 - 7 mm, flexibel, Alu., gebohrt

SKD-edge for click design flooring
 4 - 7 mm, flexible, aluminium, drilled

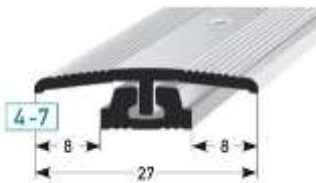

Zusätzliche Schrauben siehe Abschnitt 12.
 Additional screws, see section 12.

| | | | |
|---|-----|---------|-------|
| silberfarbig silver | 0,9 | 49014-2 | 23,02 |
| | 2,7 | 49016-6 | 55,56 |
| goldfarbig gold | 0,9 | 49018-0 | 23,78 |
| | 2,7 | 49020-3 | 58,16 |
| bronzef. hell bronze light | 0,9 | 49064-7 | 24,22 |
| | 2,7 | 49066-1 | 59,84 |
| gold hell gold light | 0,9 | 49022-7 | 23,78 |
| | 2,7 | 49024-1 | 58,16 |
| edelstahlfarbig stainless steel coloured | 0,9 | 49026-5 | 24,22 |
| | 2,7 | 49028-9 | 59,84 |

316 SKD-Höhenausgleichsprofil f. Klickdesign-Beläge f. Höhe 4 - 7 mm, flexibel, Alu., gebohrt

SKD-height levelling for click design flooring
 4 - 7 mm, flexible, aluminium, drilled



Zusätzliche Schrauben siehe Abschnitt 12.
 Additional screws, see section 12.

| | | | |
|---|-----|---------|-------|
| silberfarbig silver | 0,9 | 49030-2 | 24,22 |
| | 2,7 | 49032-6 | 59,60 |
| goldfarbig gold | 0,9 | 49034-0 | 25,16 |
| | 2,7 | 49036-4 | 62,66 |
| bronzef. hell bronze light | 0,9 | 49068-5 | 25,66 |
| | 2,7 | 49070-8 | 64,80 |
| gold hell gold light | 0,9 | 49038-8 | 25,16 |
| | 2,7 | 49040-1 | 62,66 |
| edelstahlfarbig stainless steel coloured | 0,9 | 49042-5 | 25,66 |
| | 2,7 | 49044-9 | 64,80 |

317 SKD-Abschlussprofil für Klickdesign-Beläge für Höhe 4 - 7 mm, flexibel, Alu., gebohrt

SKD-end for click design flooring
 4 - 7 mm, flexible, aluminium, drilled

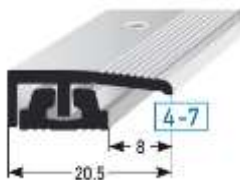

Zusätzliche Schrauben siehe Abschnitt 12.
 Additional screws, see section 12.

| | | | |
|---|-----|---------|-------|
| silberfarbig silver | 0,9 | 49046-3 | 22,66 |
| | 2,7 | 49048-7 | 54,24 |
| goldfarbig gold | 0,9 | 49050-0 | 23,26 |
| | 2,7 | 49052-4 | 56,62 |
| bronzef. hell bronze light | 0,9 | 49072-2 | 23,78 |
| | 2,7 | 49074-6 | 58,22 |
| gold hell gold light | 0,9 | 49054-8 | 23,26 |
| | 2,7 | 49056-2 | 56,62 |
| edelstahlfarbig stainless steel coloured | 0,9 | 49058-6 | 23,78 |
| | 2,7 | 49060-9 | 58,22 |

327 SKD-Lifter 4 mm für Profilerhöhung auf 8 - 11 mm, PVC, gebohrt

SKD-lifter 4 mm,
 for increase to 8 - 11 mm,
 PVC, drilled

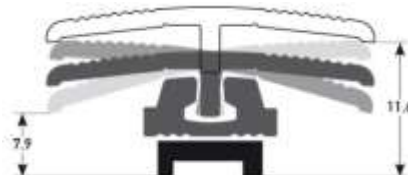

| | | |
|-----|---------|-------|
| 2,7 | 49062-3 | 26,48 |
|-----|---------|-------|

7. SYSTEMPROFILE FÜR 4-24mm BELÄGE/ 7. PROFILES FOR 4-24mm FLOORINGS

SKD - SYSTEM FÜR KLICKDESIGN-BELÄGE 4 - 7 mm, flexibel, 2-teilig

SKD - system for click design flooring 4-7 mm, flexible, 2 parts

SB-Pack incl. Schrauben + Dübel; VE 20 Stk.

self-service-pack with screws + dowels; à 20 pcs.

| Farbe/colour | L / l (m) | Art./ref. | €/Stk./pcs. |
|--------------|-----------|-----------|-------------|
|--------------|-----------|-----------|-------------|

351 SKD-Treppenkante für Klickdesign-Beläge für Höhe 4 - 7 mm, flexibel, Alu., gebohrt

SKD-stair nosing for click design flooring
 4 - 7 mm, flexible, aluminium, drilled

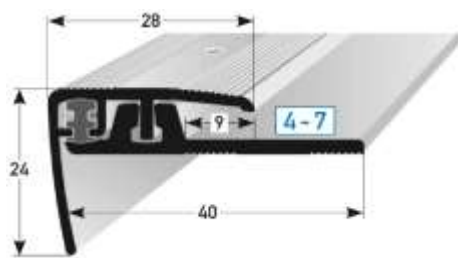

Zusätzliche Schrauben siehe Abschnitt 12.
 Additional screws, see section 12.

| | | | |
|---|-----|---------|--------|
| silberfarbig silver | 0,9 | 49078-4 | 37,00 |
| | 2,7 | 49088-3 | 99,92 |
| goldfarbig gold | 0,9 | 49080-7 | 38,38 |
| | 2,7 | 49090-6 | 103,66 |
| bronzef. hell bronze light | 0,9 | 49086-9 | 39,34 |
| | 2,7 | 49096-8 | 106,24 |
| gold hell gold light | 0,9 | 49082-1 | 38,38 |
| | 2,7 | 49092-0 | 103,66 |
| edelstahlfarbig stainless steel coloured | 0,9 | 49084-5 | 39,34 |
| | 2,7 | 49094-4 | 106,24 |

SKD - System für Klickdesign-Beläge

SKD - system for click design flooring



Beispiel: SLP-System 7 - 17 mm + 12 - 22 mm (siehe Seite 107-109)
 example: SLP-system 7 - 17 mm + 12 - 22 mm (see page 107-109)

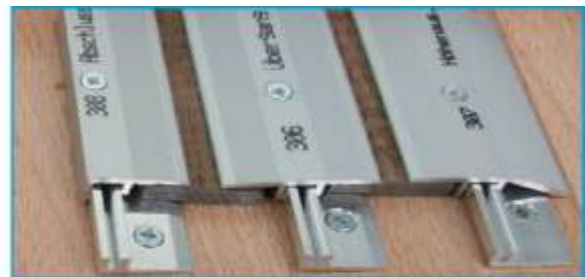

Beispiel: Mini-APL-System 5 - 9 mm (siehe Seite 95 - 98)
 example: Mini-APL-system 5 - 9 mm (see page 95 - 98)



Beispiel: APL-System 7 - 15 mm (siehe Seite 95 - 98)
 example: APL-system 7 - 15 mm (see page 95 - 98)



Beispiel: APL-KLICK-System 4 - 7 / 7 - 10 / 11 - 15 / 15 - 24 mm
 (siehe Seite 99 - 104)
 example: APL-KLICK-system 4 - 7 / 7 - 10 / 11 - 15 / 15 - 24 mm
 (see page 99 - 104)

7. SYSTEMPROFILE FÜR 4-24mm BELÄGE/ 7. PROFILES FOR 4-24mm FLOORINGS

SLP-System 7-17 mm, FLEX, 3-teilig

SLP-system 7-17 mm, flexible, 3 parts

138 SLP-Übergangprofil 35 mm für Laminat/ Parkett 7 - 17 mm flexibel, 3-teilig, Aluminium, gebohrt

SLP-edge 35 mm for laminate/ wooden floors, 7 - 17 mm, flexible 3 parts, aluminium, drilled

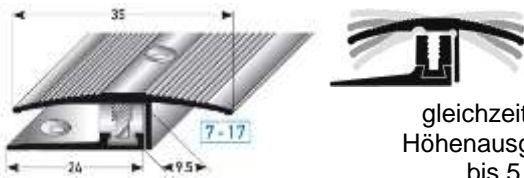

gleichzeitiger
Höhenausgleich
bis 5 mm
height levelling up to 5 mm

Grundprofilerrhöhung siehe Seite 96

basic profile increase see page 96

Zusätzliche Schrauben siehe Abschnitt 12.

Additional screws, see section 12.

| SB-Pack incl. Schrauben + Dübel; VE 20 Stk. | | | |
|---|-----------|-----------|-------------|
| self-service-pack with screws + dowels; à 20 pcs. | | | |
| Farbe/colour | L / l (m) | Art./ref. | €/Stk./pcs. |
| silberfarbig silver | 0,9 | 42005-7 | 19,82 |
| | 2,7 | 42000-2 | 59,46 |
| goldfarbig gold | 0,9 | 42015-6 | 20,18 |
| | 2,7 | 42010-1 | 60,64 |
| bronzef. hell bronze light | 0,9 | 42025-5 | 23,22 |
| | 2,7 | 42020-0 | 69,62 |
| gold hell gold light | 0,9 | 62020-4 | 20,18 |
| | 2,7 | 62025-9 | 60,64 |
| Buche beech | 0,9 | 42045-3 | 26,64 |
| | 2,7 | 42040-8 | 80,02 |
| Eiche oak | 0,9 | 42055-2 | 26,64 |
| | 2,7 | 42050-7 | 80,02 |
| Ahorn maple | 0,9 | 42065-1 | 26,64 |
| | 2,7 | 42060-6 | 80,02 |
| Kirschbaum cherry wood | 0,9 | 43254-8 | 26,64 |
| | 2,7 | 43256-2 | 80,02 |
| Eiche rustikal rustic oak | 0,9 | 43258-6 | 26,64 |
| | 2,7 | 43260-9 | 80,02 |

Holzdekorfolie/ wood decor

139 SLP-Höhenausgleichsprofil 39 mm für Laminat/ Parkett 7 - 17 mm flexibel, 3-teilig, Aluminium, gebohrt

SLP-height levelling 39 mm for laminate/ wooden floors, 7 - 17 mm, flexible, 3 parts, aluminium, drilled

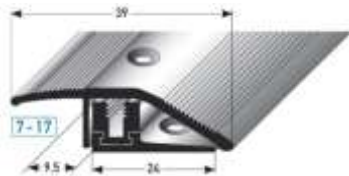

Grundprofilerrhöhung siehe Seite 96

basic profile increase see page 96

Zusätzliche Schrauben siehe Abschnitt 12.

Additional screws, see section 12.

| | | | |
|-------------------------------|-----|---------|-------|
| silberfarbig silver | 0,9 | 42075-0 | 22,10 |
| | 2,7 | 42070-5 | 66,14 |
| goldfarbig gold | 0,9 | 42085-9 | 22,44 |
| | 2,7 | 42080-4 | 67,36 |
| bronzef. hell bronze light | 0,9 | 42095-8 | 25,74 |
| | 2,7 | 42090-3 | 77,20 |
| gold hell gold light | 0,9 | 62040-2 | 22,44 |
| | 2,7 | 62045-7 | 67,36 |
| Buche beech | 0,9 | 42115-3 | 28,12 |
| | 2,7 | 42110-8 | 84,34 |
| Eiche oak | 0,9 | 42125-2 | 28,12 |
| | 2,7 | 42120-7 | 84,34 |
| Ahorn maple | 0,9 | 42135-1 | 28,12 |
| | 2,7 | 42130-6 | 84,34 |
| Kirschbaum cherry wood | 0,9 | 43264-7 | 28,12 |
| | 2,7 | 43266-1 | 84,34 |
| Eiche rustikal rustic oak | 0,9 | 43268-5 | 28,12 |
| | 2,7 | 43270-8 | 84,34 |

Holzdekorfolie/ wood decor

140 SLP-Abschlussprofil 24 mm für Laminat/ Parkett 7 - 17 mm flexibel, 3-teilig, Aluminium, gebohrt

SLP-end 24 mm for laminate/ wooden floors 7 - 17 mm, flexible, 3 parts, aluminium, drilled

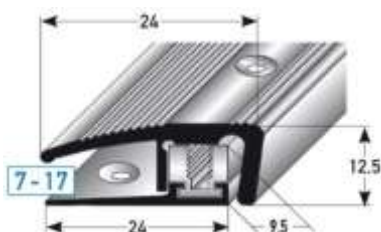

Zusätzliche Schrauben siehe Abschnitt 12.

Additional screws, see section 12.

| | | | |
|-------------------------------|-----|---------|-------|
| silberfarbig silver | 0,9 | 42145-0 | 17,96 |
| | 2,7 | 42140-5 | 53,86 |
| goldfarbig gold | 0,9 | 42155-9 | 18,36 |
| | 2,7 | 42150-4 | 55,10 |
| bronzef. hell bronze light | 0,9 | 42165-8 | 21,34 |
| | 2,7 | 42160-3 | 64,04 |
| gold hell gold light | 0,9 | 62060-0 | 18,36 |
| | 2,7 | 62065-5 | 55,10 |
| Buche beech | 0,9 | 42185-6 | 25,40 |
| | 2,7 | 42180-1 | 76,26 |
| Eiche oak | 0,9 | 42195-5 | 25,40 |
| | 2,7 | 42190-0 | 76,26 |
| Ahorn maple | 0,9 | 42205-1 | 25,40 |
| | 2,7 | 42200-6 | 76,26 |
| Kirschbaum cherry wood | 0,9 | 43274-6 | 25,40 |
| | 2,7 | 43276-0 | 76,26 |
| Eiche rustikal rustic oak | 0,9 | 43278-4 | 25,40 |
| | 2,7 | 43280-7 | 76,26 |

Holzdekorfolie/ wood decor

7. SYSTEMPROFILE FÜR 4-24mm BELÄGE/ 7. PROFILES FOR 4-24mm FLOORINGS

SLP-Treppenkante 7-15,5 mm, FLEX, 3-teilig

SLP-stair nosing 7-15,5 mm, flexible, 3 parts

SB-Pack incl. Schrauben + Dübel; VE 20 Stk.

self-service-pack with screws + dowels; à 20 pcs.

| Farbe/colour | L / l (m) | Art./ref. | €/Stk./pcs. |
|--------------|-----------|-----------|-------------|
|--------------|-----------|-----------|-------------|

141 SLP-Treppenkante 28 mm, für Laminat/ Parkett 7 - 15,5 mm, flexibel, 3-teilig, Alu., gebohrt

SLP-stair nosing 28 mm, for laminate/ wooden floors 7 - 15,5 mm, flexible, 3 parts, aluminium, drilled



Zusätzliche Schrauben siehe Abschnitt 12./
Additional screws, see section 12.

| | | | |
|-------------------------------|-----|---------|--------|
| silberfarbig silver | 0,9 | 41880-1 | 36,40 |
| | 2,7 | 41890-0 | 109,20 |
| goldfarbig gold | 0,9 | 41900-6 | 36,88 |
| | 2,7 | 41910-5 | 110,62 |
| bronzef. hell bronze light | 0,9 | 41920-4 | 41,56 |
| | 2,7 | 41930-3 | 124,72 |
| gold hell gold light | 0,9 | 62000-6 | 36,88 |
| | 2,7 | 62005-1 | 110,62 |

SLP-System für Parkett 12-22 mm, FLEX, 3-teilig

SLP-system for wooden floors 12-22 mm, flexible, 3 parts

164 SLP-Übergangprofil 35 mm, für Parkett 12 - 22 mm, flexibel, 3-teilig, Aluminium, gebohrt

SLP-edge 35 mm for wooden floors 12 - 22 mm, flexible, 3 parts, aluminium, drilled

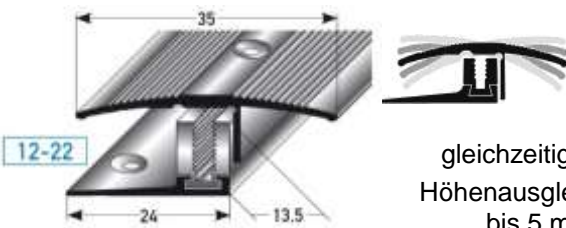

gleichzeitiger
Höhenausgleich
bis 5 mm
height levelling up to 5 mm

Grundprofilerhöhung siehe Seite 96

basic profile increase see page 96

Zusätzliche Schrauben siehe Abschnitt 12.

Additional screws, see section 12.

Holzdekorfolie/ wood decor

| | | | |
|-------------------------------|-----|---------|-------|
| silberfarbig silver | 0,9 | 43000-1 | 25,56 |
| | 2,7 | 43002-5 | 72,18 |
| goldfarbig gold | 0,9 | 43004-9 | 26,00 |
| | 2,7 | 43006-3 | 73,58 |
| bronzef. hell bronze light | 0,9 | 43008-7 | 29,52 |
| | 2,7 | 43010-0 | 84,08 |
| gold hell gold light | 0,9 | 43012-4 | 26,00 |
| | 2,7 | 43014-8 | 73,58 |
| Buche beech | 0,9 | 43016-2 | 33,56 |
| | 2,7 | 43018-6 | 96,36 |
| Eiche oak | 0,9 | 43020-9 | 33,56 |
| | 2,7 | 43022-3 | 96,36 |
| Ahorn maple | 0,9 | 43024-7 | 33,56 |
| | 2,7 | 43026-1 | 96,36 |
| Kirschbaum cherry wood | 0,9 | 43028-5 | 33,56 |
| | 2,7 | 43030-8 | 96,36 |
| Eiche rustikal rustic oak | 0,9 | 43032-2 | 33,56 |
| | 2,7 | 43034-6 | 96,36 |

153 SLP-Höhenausgleichsprofil 50 mm, f. Parkett 12 - 22 mm, flexibel, 3-teilig, Alu., gebohrt

SLP-height levelling 50 mm for wooden floors 12 - 22 mm, flexible, 3 parts, aluminium, drilled

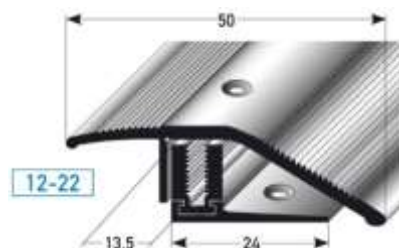

Grundprofilerhöhung siehe Seite 96

basic profile increase see page 96

Zusätzliche Schrauben siehe Abschnitt 12.

Additional screws, see section 12.

Holzdekorfolie/ wood decor

| | | | |
|-------------------------------|-----|---------|--------|
| silberfarbig silver | 0,9 | 43046-9 | 32,34 |
| | 2,7 | 43048-3 | 96,84 |
| goldfarbig gold | 0,9 | 43050-6 | 32,88 |
| | 2,7 | 43052-0 | 98,60 |
| bronzef. hell bronze light | 0,9 | 43054-4 | 37,82 |
| | 2,7 | 43056-8 | 113,48 |
| gold hell gold light | 0,9 | 43058-2 | 32,88 |
| | 2,7 | 43060-5 | 98,60 |
| Buche beech | 0,9 | 43062-9 | 41,42 |
| | 2,7 | 43064-3 | 124,20 |
| Eiche oak | 0,9 | 43066-7 | 41,42 |
| | 2,7 | 43068-1 | 124,20 |
| Ahorn maple | 0,9 | 43070-4 | 41,42 |
| | 2,7 | 43072-8 | 124,20 |
| Kirschbaum cherry wood | 0,9 | 43074-2 | 41,42 |
| | 2,7 | 43076-6 | 124,20 |
| Eiche rustikal rustic oak | 0,9 | 43078-0 | 41,42 |
| | 2,7 | 43080-3 | 124,20 |

7. SYSTEMPROFILE FÜR 4-24mm BELÄGE/ 7. PROFILES FOR 4-24mm FLOORINGS

SLP-System 7-17 mm, Edelstahl matt, FLEX, für Laminat/ Parkett

SLP-system 7-17 mm, stainless steel matt, flexible, for laminate/ wooden floors

SB-Pack incl. Schrauben + Dübel; VE 20 Stk.

self-service-pack with screws + dowels; à 20 pcs.

| Dimension in mm | L / l (m) | Art./ref. | €/Stk./pcs. |
|-----------------|-----------|-----------|-------------|
|-----------------|-----------|-----------|-------------|

151 SLP-Übergangprofil 37 mm, Edelstahl matt, für 7 - 17 mm, flexibel, 3-teilig, gebohrt

SLP-edge 37 mm, stainless steel matt, for 7 - 17 mm, flexible, 3 parts, drilled

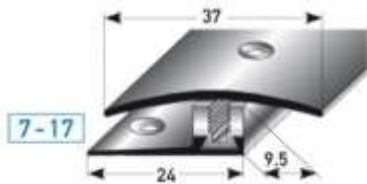

| | | | |
|-------------|-----|---------|-------|
| 37 x 1,5 mm | 0,9 | 42900-5 | 29,70 |
| | 2,7 | 42905-0 | 89,08 |



gleichzeitig Höhenausgleich bis 5 mm
 height levelling up to 5 mm

Zusätzliche Schrauben siehe Abschnitt 12.
 Additional screws, see section 12.

152 SLP-Höhenausgleichprofil 40 mm, Edelstahl matt, für 7 - 17 mm, flex, 3-teilig, gebohrt

SLP-height levelling 40 mm, stainless steel matt, for 7 - 17 mm, flexible, 3 parts, drilled

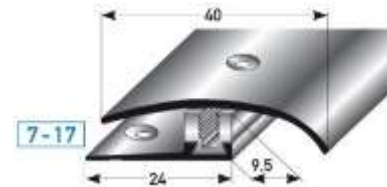

| | | | |
|-------------|-----|---------|-------|
| 40 x 1,5 mm | 0,9 | 42910-4 | 31,18 |
| | 2,7 | 42915-9 | 93,48 |

Zusätzliche Schrauben siehe Abschnitt 12.
 Additional screws, see section 12.

148 SLP-Abschlussprofil 26 mm, Edelstahl matt, f. Gesamthöhe 7 - 9 mm, flex., 3-teilig, gebohrt

SLP-end 26 mm, stainless steel matt, for heights 7 - 9 mm, flexible, 3 parts, drilled

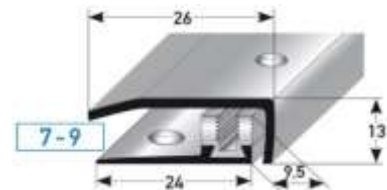

| | | | |
|-------------------|-----|---------|-------|
| 7-9 x 26 x 1,5 mm | 0,9 | 42920-3 | 29,70 |
| | 2,7 | 42925-8 | 89,08 |

Zusätzliche Schrauben siehe Abschnitt 12.
 Additional screws, see section 12.

149 SLP-Abschlussprof. 28 mm, Edelst. matt, f. Gesamthöhe 10 - 13 mm, flex., 3-teilig, gebohrt

SLP-end 28 mm, stainless steel matt, for heights 10 - 13 mm, flexible, 3 parts, drilled

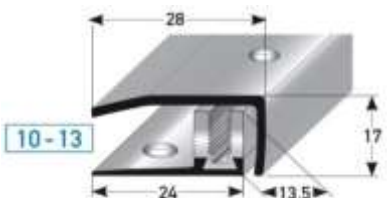

| | | | |
|---------------------|-----|---------|-------|
| 10-13 x 28 x 1,5 mm | 0,9 | 42930-2 | 31,18 |
| | 2,7 | 42935-7 | 93,48 |

Zusätzliche Schrauben siehe Abschnitt 12.
 Additional screws, see section 12.

150 SLP-Abschlussprof. 26 mm, Edelst. matt, f. Gesamthöhe 14 - 17 mm, flex., 3-teilig, gebohrt

SLP-end 26 mm, stainless steel matt, for heights 14 - 17 mm, flexible, 3 parts, drilled

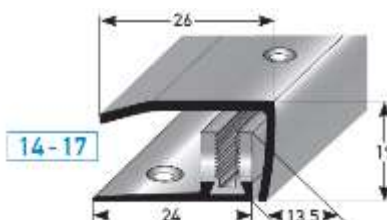

| | | | |
|---------------------|-----|---------|-------|
| 14-17 x 26 x 1,5 mm | 0,9 | 42940-1 | 31,18 |
| | 2,7 | 42945-6 | 93,48 |

Zusätzliche Schrauben siehe Abschnitt 12.
 Additional screws, see section 12.

8. SOCKELLEISTEN AUS EDELSTAHL & ALUMINIUM

8. SKIRTINGS OUT OF STAINLESS STEEL + ALUMINIUM



8. SOCKELLEISTEN/ 8. SKIRTINGS

Andere Abmaße auf Anfrage/ other dimensions on demand

| Flach-Sockelleiste aus Edelstahl, matt gebürstet, TYP i-Form | | | | | | | |
|--|-----------|---|-----------|-------------|---|-----------|-------------|
| flat skirting, stainless steel matt brushed, type i-form | | | | | | | |
| Breite/ width A (mm) | L / l (m) | B = 1,0 mm Materialstärke/ thickness | | | B = 1,5 mm Materialstärke/ thickness | | |
| | | Koffernr. case no. | Art./ref. | €/Stk./pcs. | Koffernr. case no. | Art./ref. | €/Stk./pcs. |

413 Flach-Sockelleiste 1,0 / 1,5 / 2,0 / 3,0 mm, Edelstahl matt

flat skirting
 1,0/ 1,5/ 2,0/ 3,0 mm,
 stainless steel matt



| | | | | | | | |
|--------|------|-----|---------|-------|-----|---------|-------|
| 30 mm | 1,00 | 548 | 72648-7 | 9,06 | 549 | 72660-9 | 13,10 |
| | 2,50 | | 72650-0 | 22,66 | | 72662-3 | 32,72 |
| 35 mm | 1,00 | 550 | 72652-4 | 10,58 | 551 | 72664-7 | 15,06 |
| | 2,50 | | 72654-8 | 26,44 | | 72666-1 | 27,48 |
| 40 mm | 1,00 | 442 | 68350-6 | 11,64 | 443 | 68362-9 | 17,50 |
| | 2,50 | | 68352-0 | 29,10 | | 68364-3 | 43,68 |
| 45 mm | 1,00 | 552 | 72656-2 | 13,60 | 553 | 72668-5 | 18,56 |
| | 2,50 | | 72658-6 | 33,98 | | 72670-8 | 46,42 |
| 50 mm | 1,00 | 285 | 67420-7 | 15,60 | 288 | 67442-9 | 19,64 |
| | 2,50 | | 61892-8 | 39,26 | | 61906-2 | 49,10 |
| 60 mm | 1,00 | 286 | 67422-1 | 19,38 | 289 | 67444-3 | 23,56 |
| | 2,50 | | 61894-2 | 48,46 | | 61908-6 | 58,92 |
| 70 mm | 1,00 | 414 | 67424-5 | 21,66 | 416 | 67446-7 | 27,48 |
| | 2,50 | | 67426-9 | 54,06 | | 67448-1 | 68,74 |
| 80 mm | 1,00 | 287 | 67428-3 | 24,36 | 290 | 67450-4 | 31,40 |
| | 2,50 | | 61896-6 | 60,94 | | 61910-9 | 78,52 |
| 100 mm | 1,00 | 415 | 67430-6 | 30,90 | 291 | 67452-8 | 39,28 |
| | 2,50 | | 67432-0 | 77,30 | | 61912-3 | 98,16 |

Bitte Befestigungstyp angeben:

- 01 mittig gebohrt
- 02 seitlich gebohrt
- 03 wechselseitig seitlich
- 04 ungebohrt
- 05 selbstklebend

Please specify fixing:

- 01 drilled centrally
- 02 drilled laterally
- 03 alternating sides drilled
- 04 undrilled
- 05 self adhesive



| Breite/ width A (mm) | L / l (m) | B = 2,0 mm Materialstärke/ thickness | | | B = 3,0 mm Materialstärke/ thickness | | |
|-------------------------|-----------|---|-----------|-------------|---|-----------|-------------|
| | | Koffernr. case no. | Art./ref. | €/Stk./pcs. | Koffernr. case no. | Art./ref. | €/Stk./pcs. |
| 30 mm | 1,00 | 554 | 72672-2 | 17,38 | 555 | 72684-5 | 24,54 |
| | 2,50 | | 72674-6 | 43,42 | | 72686-9 | 61,36 |
| 35 mm | 1,00 | 556 | 72676-0 | 20,14 | 557 | 72688-3 | 28,64 |
| | 2,50 | | 72678-4 | 50,66 | | 72690-6 | 71,60 |
| 40 mm | 1,00 | 444 | 68374-2 | 23,28 | 445 | 68386-5 | 34,94 |
| | 2,50 | | 68376-6 | 58,26 | | 68388-9 | 87,36 |
| 45 mm | 1,00 | 558 | 72680-7 | 24,74 | 559 | 72692-0 | 36,82 |
| | 2,50 | | 72682-1 | 61,84 | | 72694-4 | 92,06 |
| 50 mm | 1,00 | 417 | 67464-1 | 26,18 | 422 | 67496-2 | 39,28 |
| | 2,50 | | 67466-5 | 65,46 | | 67498-6 | 98,16 |
| 60 mm | 1,00 | 418 | 67468-9 | 31,40 | 423 | 67500-6 | 47,12 |
| | 2,50 | | 67470-2 | 78,52 | | 67502-0 | 117,80 |
| 70 mm | 1,00 | 419 | 67472-6 | 36,66 | 424 | 67504-4 | 54,98 |
| | 2,50 | | 67474-0 | 91,62 | | 67506-8 | 137,44 |
| 80 mm | 1,00 | 420 | 67476-4 | 41,90 | 425 | 67508-2 | 62,84 |
| | 2,50 | | 67478-8 | 104,74 | | 67510-5 | 157,08 |
| 100 mm | 1,00 | 421 | 67480-1 | 52,36 | 426 | 67512-9 | 78,52 |
| | 2,50 | | 67482-5 | 130,90 | | 67514-3 | 196,36 |

Anfertigung von passenden
 Innen- und Außenecken
 siehe Seite 113 - Lieferzeit
 nach Vereinbarung
 production of matching corners
 see page 113 - delivery time by
 prior arrangement

Bohrungen bis 2 mm Stärke für 3,5 mm Schrauben;
Bohrungen bei 3 mm Stärke für 4 mm Schrauben
 holes up to 2 mm thickness for 3.5 mm screws;
 drilling at 3 mm for 4 mm screws

Edelstahlschrauben siehe Abschnitt 12
 stainless steel screws see section 12

8. SOCKELLEISTEN/ 8. SKIRTINGS

| Abkant-Sockelleiste Edelstahl matt, gekantet, TYP L- & j-Form | | | | | | | |
|--|-----------|-----------------------------|-----|---------------------|-----|---------------------|-----|
| edged skirting out of stainless steel matt, type L- + j-form | | | | | | | |
| Bitte bei Bestellung immer Winkel, 94° oder 135°, angeben! Please specify when ordering the number of degrees of tilt with 94° or 135°! | | | | | | | |
| AxBxC mm | L / l (m) | selbstkl./ self-adhesive | €/m | gebohrt/ drilled | €/m | ohne alles/ bare | €/m |

Andere Abmaße auf
Anfrage/ other dimensions
on demand

Abkant-Sockelleiste, **Edelstahl** matt, gekantet auf 94° oder 135°

edged skirting, stainless
steel matt, edged 94°
or 135°

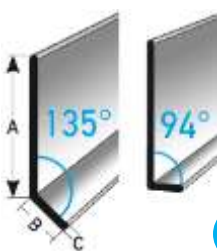

473

| | | | | | | | |
|---------------|-----|---------|---------|---------|---------|---------|---------|
| 40 x 10 x 1,0 | 2,5 | 69704-6 | 15,46/m | 69718-3 | 14,20/m | 69732-9 | 12,48/m |
| 40 x 15 x 1,0 | 2,5 | 69706-0 | 16,68/m | 69720-6 | 15,46/m | 69734-3 | 13,72/m |
| 40 x 10 x 1,5 | 2,5 | 69708-4 | 21,70/m | 69722-0 | 20,44/m | 69736-7 | 18,72/m |
| 40 x 15 x 1,5 | 2,5 | 69710-7 | 23,58/m | 69724-4 | 22,32/m | 69738-1 | 20,60/m |
| 40 x 15 x 2,0 | 2,5 | 69712-1 | 30,42/m | 69726-8 | 29,20/m | 69740-4 | 27,44/m |
| 40 x 15 x 3,0 | 2,5 | 69714-5 | 44,14/m | 69728-2 | 42,90/m | 69742-8 | 41,16/m |

223

| | | | | | | | |
|---------------|-----|---------|---------|---------|---------|---------|---------|
| 50 x 10 x 1,0 | 2,5 | 69748-0 | 16,56/m | 69762-6 | 15,30/m | 60320-7 | 13,58/m |
| 50 x 15 x 1,0 | 2,5 | 69750-3 | 16,68/m | 69764-0 | 15,46/m | 69778-7 | 13,72/m |
| 50 x 10 x 1,5 | 2,5 | 69752-7 | 25,42/m | 69766-4 | 24,18/m | 69780-0 | 22,44/m |
| 50 x 15 x 1,5 | 2,5 | 69754-1 | 27,32/m | 69768-8 | 26,08/m | 69782-4 | 24,34/m |
| 50 x 15 x 2,0 | 2,5 | 69756-5 | 35,42/m | 69770-1 | 34,18/m | 69784-8 | 32,44/m |
| 50 x 15 x 3,0 | 2,5 | 69758-9 | 51,66/m | 69772-5 | 50,42/m | 69786-2 | 48,68/m |

Bitte bei
Bestellung die
genaue Gradzahl
angeben!

Please specify the exact
number of degrees
when ordering!

224

| | | | | | | | |
|---------------|-----|---------|---------|---------|---------|---------|---------|
| 60 x 10 x 1,0 | 2,5 | 69792-3 | 20,44/m | 69806-7 | 19,22/m | 69820-3 | 17,50/m |
| 60 x 15 x 1,0 | 2,5 | 69794-7 | 27,00/m | 69808-1 | 25,78/m | 61600-9 | 24,04/m |
| 60 x 10 x 1,5 | 2,5 | 69796-1 | 29,18/m | 69810-4 | 27,92/m | 69824-1 | 26,20/m |
| 60 x 15 x 1,5 | 2,5 | 69798-5 | 31,02/m | 69812-8 | 29,82/m | 69826-5 | 28,10/m |
| 60 x 15 x 2,0 | 2,5 | 69800-5 | 40,40/m | 69814-2 | 39,20/m | 69828-9 | 37,42/m |
| 60 x 15 x 3,0 | 2,5 | 69802-9 | 59,12/m | 69816-6 | 57,90/m | 69830-2 | 56,14/m |

225

| | | | | | | | |
|---------------|-----|---------|---------|---------|---------|---------|---------|
| 80 x 10 x 1,0 | 2,5 | 69836-4 | 25,42/m | 69850-0 | 24,18/m | 69864-7 | 22,44/m |
| 80 x 15 x 1,0 | 2,5 | 69838-8 | 32,02/m | 69852-4 | 30,78/m | 61610-8 | 29,04/m |
| 80 x 10 x 1,5 | 2,5 | 69840-1 | 36,68/m | 69854-8 | 35,44/m | 69868-5 | 33,72/m |
| 80 x 15 x 1,5 | 2,5 | 69842-5 | 38,52/m | 69856-2 | 37,30/m | 69870-8 | 35,54/m |
| 80 x 15 x 2,0 | 2,5 | 69844-9 | 50,40/m | 69858-6 | 49,14/m | 69872-2 | 47,42/m |
| 80 x 15 x 3,0 | 2,5 | 69846-3 | 74,12/m | 69860-9 | 72,86/m | 69874-6 | 71,14/m |

226

| | | | | | | | |
|----------------|-----|---------|---------|---------|---------|---------|---------|
| 100 x 10 x 1,0 | 2,5 | 69880-7 | 31,92/m | 69894-4 | 29,20/m | 69908-8 | 27,44/m |
| 100 x 15 x 1,0 | 2,5 | 69882-1 | 33,16/m | 69896-8 | 30,42/m | 69910-1 | 28,70/m |
| 100 x 10 x 1,5 | 2,5 | 69884-5 | 45,64/m | 69898-2 | 42,90/m | 69912-5 | 41,16/m |
| 100 x 15 x 1,5 | 2,5 | 69886-9 | 47,52/m | 69900-2 | 44,80/m | 61620-7 | 43,06/m |
| 100 x 15 x 2,0 | 2,5 | 69888-3 | 61,84/m | 69902-6 | 59,12/m | 69916-3 | 57,40/m |
| 100 x 15 x 3,0 | 2,5 | 69890-6 | 90,58/m | 69904-0 | 87,84/m | 69918-7 | 86,10/m |

Anfertigung von passenden Innen- und Außenecken siehe Seite 113 - Lieferzeit nach Vereinbarung

production of matching corners see page 113 - delivery time by prior arrangement

Abkantung mit Dach, um alte Sockelleisten zu überdecken,
auf Anfrage erhältlich

edged with a roof to cover old skirtings, available on request



8. SOCKELLEISTEN/ 8. SKIRTINGS

Andere Abmaße auf
 Anfrage/ other dimensions
 on demand

| Einklebe-Sockelleiste Edelstahl matt, gekantet, TYP r-Form | | | | | | | |
|---|-----------|-----------------------------|-----|---------------------|-----|---------------------|-----|
| stainless steel skirting for bonding flooring, edged, matt, type r-form | | | | | | | |
| AxBxC mm | L / l (m) | selbstkl./ self-adhesive | €/m | gebohrt/ drilled | €/m | ohne alles/ bare | €/m |

Einklebe-Sockelleiste Edelstahl matt, gekantet

stainless steel
 skirtings for bonding
 flooring, edged, matt



| | | | | | | | | |
|-----|----------------|-----|---------|---------|---------|---------|---------|---------|
| 452 | 40 x 6 x 1,0 | 2,5 | 68618-7 | 14,48/m | 68626-2 | 13,22/m | 68634-7 | 11,50/m |
| | 40 x 11 x 1,0 | 2,5 | 68620-0 | 15,70/m | 68628-6 | 14,48/m | 68636-1 | 12,72/m |
| 453 | 50 x 6 x 1,0 | 2,5 | 68642-2 | 16,96/m | 68650-7 | 15,70/m | 68658-3 | 13,98/m |
| | 50 x 11 x 1,0 | 2,5 | 68644-6 | 18,18/m | 68652-1 | 16,98/m | 68660-6 | 15,24/m |
| 454 | 60 x 6 x 1,0 | 2,5 | 68666-8 | 19,42/m | 68674-3 | 18,18/m | 68682-8 | 16,46/m |
| | 60 x 11 x 1,0 | 2,5 | 68668-2 | 20,70/m | 68676-7 | 19,46/m | 68684-2 | 17,72/m |
| 455 | 80 x 6 x 1,0 | 2,5 | 68690-3 | 24,42/m | 68698-9 | 23,20/m | 68706-1 | 21,46/m |
| | 80 x 11 x 1,0 | 2,5 | 68692-7 | 25,68/m | 68700-9 | 24,42/m | 68708-5 | 22,70/m |
| 456 | 100 x 6 x 1,5 | 2,5 | 68714-6 | 44,14/m | 68722-1 | 41,42/m | 68730-6 | 39,70/m |
| | 100 x 11 x 1,5 | 2,5 | 68716-0 | 46,00/m | 68724-5 | 43,28/m | 68732-0 | 41,54/m |

Anfertigung von passenden Innen- und Außenecken siehe unten - Lieferzeit nach Vereinbarung

production of matching corners see below - bdelivery time by prior arrangement

Passende Ecken (30 x 30 mm), feingeschweißt, für alle Sockelleisten:

auf Gehrung geschnitten, feingeschweißt, als 90°-Ecke

matching corners (30 x 30 mm) for all skirtings, finely welded, as a 90 ° corner

| | Art./ref. | Preis pro Ecke price per corner |
|------------------------------------|-----------|--|
| Innenecke inside corner | 61830-0 | Laufmeterpreis der jeweiligen Sockelleiste = Preis pro Ecke price per meter of the respective skirting = price per corner |
| Außenecke outside corner | 61840-9 | |

Auf Wunsch an Stange gearbeitet./ Worked on rod on request.

Andere Gradzahlen auf Anfrage möglich. / Other degrees possible on request.

Lieferzeit nach Vereinbarung

delivery time by prior arrangement

Beispiel: Außenecke
 Aluminium silber
 example: outside corner
 aluminium silver

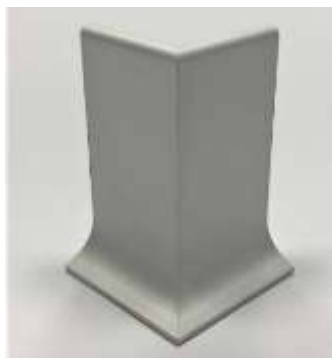

Beispiel: Innenecke
 Aluminium silber
 example: inside corner
 aluminium silver



8. SOCKELLEISTEN/ 8. SKIRTINGS

Andere Abmaße auf Anfrage/
other dimensions on demand

Lieferzeit für Pulver-
beschichtung auf Anfrage
delivery time for powder coating on
request

| Aluminium-Flach-Sockelleiste Typ i-Form | | | | | | | |
|--|-----------|-----------------------------|-----|---------------------|-----|---------------------|-----|
| aluminium flat skirting type i-form | | | | | | | |
| AxB mm | L / l (m) | selbstkl./ self-adhesive | €/m | gebohrt/ drilled | €/m | ohne alles/ bare | €/m |
| Selbstklebende Sockelleisten zusätzlich punktweise mit Montagekleber befestigen! Please fasten self adhesive skirtings also with dots of builders adhesive! | | | | | | | |

Flach-Sockelleiste, Aluminium, Typ i-Form

flat skirting,
aluminium,
type i-form

457
538
539

| | | | | | | | | |
|---|--|------|---------|---------|---------|---------|---------|---------|
| silber elox. silver anodized | 40 x 1,0 | 2,5 | 68736-8 | 8,70/m | 68744-3 | 7,48/m | 68752-8 | 5,72/m |
| | 40 x 2,0 | 2,5 | 68738-2 | 14,48/m | 68746-7 | 13,22/m | 68754-2 | 11,50/m |
| | 40 x 3,0 | 2,5* | 68740-5 | 20,22/m | 68748-1 | 19,00/m | 68756-6 | 17,24/m |
| edelstahl- farbig stainless steel coloured | 40 x 1,0 | 2,5* | 68760-3 | 10,96/m | 68768-9 | 9,70/m | 68776-4 | 7,98/m |
| | 40 x 2,0 | 2,5* | 68762-7 | 16,68/m | 68770-2 | 15,46/m | 68778-8 | 13,72/m |
| | 40 x 3,0 | 2,5* | 68764-1 | 22,44/m | 68772-6 | 21,22/m | 68780-1 | 19,50/m |
| Pulvern n. RAL/ powder RAL (Preis ab 150 lfm./ price from 150 m) | 40 x 1,0 | 2,5 | 68784-9 | 16,16/m | 68792-4 | 14,90/m | 68800-6 | 13,18/m |
| | 40 x 2,0 | 2,5 | 68786-3 | 21,88/m | 68794-8 | 20,64/m | 68802-0 | 18,90/m |
| | 40 x 3,0 | 2,5 | 68788-7 | 27,68/m | 68796-2 | 26,42/m | 68804-4 | 24,70/m |
| | Pulvern nach RAL unter 150 lfm. auf Anfrage powdered (RAL) less than 150 m on request | | | | | | | |

HÖHE/ height
40 mm



458
540
541

| | | | | | | | | |
|---|--|------|---------|---------|---------|---------|---------|---------|
| silber elox. silver anodized | 50 x 1,0 | 2,5 | 68808-2 | 10,16/m | 68816-7 | 8,92/m | 68824-2 | 7,18/m |
| | 50 x 2,0 | 2,5 | 68810-5 | 17,36/m | 68818-1 | 16,12/m | 68826-6 | 14,38/m |
| | 50 x 3,0 | 2,5* | 68812-9 | 24,04/m | 68820-4 | 22,80/m | 68828-0 | 21,08/m |
| edelstahl- farbig stainless steel coloured | 50 x 1,0 | 2,5* | 68832-7 | 12,12/m | 68840-2 | 10,90/m | 68848-8 | 9,16/m |
| | 50 x 2,0 | 2,5* | 68834-1 | 19,60/m | 68842-6 | 18,34/m | 68850-1 | 16,62/m |
| | 50 x 3,0 | 2,5* | 68836-5 | 26,24/m | 68844-0 | 24,98/m | 68852-5 | 23,26/m |
| Pulvern n. RAL/ powder RAL (Preis ab 150 lfm./ price from 150 m) | 50 x 1,0 | 2,5 | 68856-3 | 17,58/m | 68864-8 | 16,34/m | 68872-3 | 14,60/m |
| | 50 x 2,0 | 2,5 | 68858-7 | 24,78/m | 68866-2 | 23,56/m | 68874-7 | 21,82/m |
| | 50 x 3,0 | 2,5 | 68860-0 | 31,48/m | 68868-6 | 30,24/m | 68876-1 | 28,50/m |
| | Pulvern nach RAL unter 150 lfm. auf Anfrage powdered (RAL) less than 150 m on request | | | | | | | |

HÖHE/ height
50 mm

298
428
299
300

| | | | | | | | | |
|---|--|------|---------|---------|---------|---------|---------|---------|
| silber elox. silver anodized | 60 x 1,0 | 2,5 | 61918-5 | 12,22/m | 61924-6 | 10,74/m | 61930-7 | 9,22/m |
| | 60 x 2,0 | 2,5 | 67240-1 | 17,54/m | 67246-3 | 17,12/m | 67252-4 | 14,54/m |
| | 60 x 3,0 | 2,5* | 61938-3 | 25,40/m | 61944-4 | 23,96/m | 61950-5 | 22,38/m |
| | 60 x 5,0 | 3,0* | 61958-1 | 38,20/m | 61964-2 | 36,78/m | 61970-3 | 35,18/m |
| edelstahl- farbig stainless steel coloured | 60 x 1,0 | 2,5* | 61920-8 | 14,20/m | 61926-0 | 12,76/m | 61932-1 | 11,18/m |
| | 60 x 2,0 | 2,5* | 67242-5 | 23,52/m | 67248-7 | 22,08/m | 67254-8 | 20,54/m |
| | 60 x 3,0 | 2,5* | 61940-6 | 27,40/m | 61946-8 | 25,98/m | 61952-9 | 24,40/m |
| | 60 x 5,0 | 3,0* | 61960-4 | 40,20/m | 61966-6 | 38,78/m | 61972-7 | 37,20/m |
| Pulvern n. RAL/ powder RAL (Preis ab 150 lfm./ price from 150 m) | 60 x 1,0 | 2,5 | 61922-2 | 20,60/m | 61928-4 | 19,18/m | 61934-5 | 17,58/m |
| | 60 x 2,0 | 2,5 | 67244-9 | 24,02/m | 67250-0 | 22,60/m | 67256-2 | 21,06/m |
| | 60 x 3,0 | 2,5 | 61942-0 | 33,80/m | 61948-2 | 32,36/m | 61954-3 | 30,78/m |
| | 60 x 5,0 | 3,0 | 61962-8 | 46,60/m | 61968-0 | 45,14/m | 61974-1 | 43,60/m |
| | Pulvern nach RAL unter 150 lfm. auf Anfrage powdered (RAL) less than 150 m on request | | | | | | | |

* inklusive 40 mm
Klemmstelle an
einer Seite vom
Eloxieren/ including
40 mm clamping point
on one side by
anodizing

3,0 m-Ware ist nur per Spedition lieferbar (gesonderte Transportkosten)

3,0 m profiles are only available per forwarding agency (separate transport costs)

Anfertigung von passenden Innen- und Außenecken siehe Seite 113 - Lieferzeit nach Vereinbarung
production of matching corners see page 113 - delivery time by prior arrangement

8. SOCKELLEISTEN/ 8. SKIRTINGS

Andere Abmaße auf Anfrage/

other dimensions on demand

Lieferzeit für Pulverbeschichtung auf Anfrage

delivery time for powder coating on request

| Aluminium-Flach-Sockelleiste Typ i-Form | | | | | | | |
|--|-----------|-----------------------------|-----|---------------------|-----|---------------------|-----|
| aluminium flat skirting type i-form | | | | | | | |
| AxB mm | L / l (m) | selbstkl./ self-adhesive | €/m | gebohrt/ drilled | €/m | ohne alles/ bare | €/m |
| Selbstklebende Sockelleisten zusätzlich punktweise mit Montagekleber befestigen! Please fasten self adhesive skirtings also with dots of builders adhesive! | | | | | | | |

Flach-Sockelleiste, Aluminium, Typ i-Form

flat skirting,
aluminium,
type i-form

542
543
544

| | | | | | | | | |
|--|----------|------|---------|---------|---------|---------|---------|---------|
| silber elox. silver anodized | 80 x 1,0 | 2,5 | 68880-8 | 14,48/m | 68888-4 | ##### | 68896-9 | 11,50/m |
| | 80 x 2,0 | 2,5 | 68882-2 | 25,98/m | 68890-7 | 24,74/m | 68898-3 | 23,02/m |
| | 80 x 3,0 | 2,5* | 68884-6 | 37,44/m | 68892-1 | 36,24/m | 68900-3 | 34,50/m |
| edelstahl- farbig stainless steel coloured | 80 x 1,0 | 2,5* | 68904-1 | 17,42/m | 68912-6 | 16,20/m | 68920-1 | 14,48/m |
| | 80 x 2,0 | 2,5* | 68906-5 | 28,94/m | 68914-0 | 27,72/m | 68922-5 | 25,98/m |
| | 80 x 3,0 | 2,5* | 68908-9 | 40,42/m | 68916-4 | 39,22/m | 68924-9 | 37,44/m |
| Pulvern n. RAL/ powder RAL (Preis ab 150 lfm./ price from 150 m) | 80 x 1,0 | 2,5 | 68928-7 | 22,86/m | 68936-2 | 21,66/m | 68944-7 | 19,88/m |
| | 80 x 2,0 | 2,5 | 68930-0 | 34,38/m | 68938-6 | 33,16/m | 68946-1 | 31,40/m |
| | 80 x 3,0 | 2,5 | 68932-4 | 45,88/m | 68940-9 | 44,62/m | 68948-5 | 42,90/m |
| Pulvern nach RAL unter 150 lfm. auf Anfrage powdered (RAL) less than 150 m on request | | | | | | | | |

HÖHE/ height
80 mm



545
546
547

| | | | | | | | | |
|--|-----------|------|---------|---------|---------|---------|---------|---------|
| silber elox. silver anodized | 100 x 1,0 | 2,5 | 68952-2 | 18,84/m | 68960-7 | 16,12/m | 68968-3 | 14,38/m |
| | 100 x 2,0 | 2,5 | 68954-6 | 33,22/m | 68962-1 | 30,46/m | 68970-6 | 28,74/m |
| | 100 x 3,0 | 2,5* | 68956-0 | 47,58/m | 68964-5 | 44,88/m | 68972-0 | 43,12/m |
| edelstahl- farbig stainless steel coloured | 100 x 1,0 | 2,5* | 68976-8 | 22,58/m | 68984-3 | 19,82/m | 68992-8 | 18,10/m |
| | 100 x 2,0 | 2,5* | 68978-2 | 36,92/m | 68986-7 | 34,20/m | 68994-2 | 32,46/m |
| | 100 x 3,0 | 2,5* | 68980-5 | 51,32/m | 68988-1 | 48,56/m | 68996-6 | 46,84/m |
| Pulvern n. RAL/ powder RAL (Preis ab 150 lfm./ price from 150 m) | 100 x 1,0 | 2,5 | 69000-9 | 27,76/m | 69008-5 | 25,06/m | 69016-0 | 23,28/m |
| | 100 x 2,0 | 2,5 | 69002-3 | 42,10/m | 69010-8 | 39,40/m | 69018-4 | 37,68/m |
| | 100 x 3,0 | 2,5 | 69004-7 | 56,50/m | 69012-2 | 53,78/m | 69020-7 | 52,06/m |
| Pulvern nach RAL unter 150 lfm. auf Anfrage powdered (RAL) less than 150 m on request | | | | | | | | |

HÖHE/ height
100 mm

Anfertigung von passenden Innen- und Außenecken siehe Seite 113 - Lieferzeit nach Vereinbarung

production of matching corners see page 113 - delivery time by prior arrangement

* inklusive 40 mm Klemmstelle an einer Seite vom Eloxieren/ including 40 mm clamping point on one side by anodizing

| Sockelblech | | | | |
|---|---------------|-----------|-----------|------------------|
| skirting metal sheet | | | | |
| Material/Befestigung material/fixing | A x B (mm) | L / l (m) | Art./ref. | €/Stk. €/pcs. |

Sockelblech 200 x 1 mm/ skirting metal sheet 200 x 1 mm

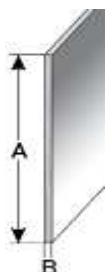

| | | | | |
|---|---------|-------|---------|-------|
| Aluminium blank, gelocht aluminium bare, drilled | 200 x 1 | 1,0 m | 22060-2 | 18,74 |
|---|---------|-------|---------|-------|

andere Abmaße auf Anfrage/ other dimensions on request

8. SOCKELLEISTEN/ 8. SKIRTINGS

Andere Abmaße auf Anfrage/
other dimensions on demand

Lieferzeit für Pulverbeschichtung auf Anfrage
delivery time for powder coating on request

| Abkant-Sockelleiste Aluminium, L- & j-Form | | | | | | | |
|--|-----------|-----------------------------|-----|---------------------|-----|---------------------|-----|
| edged skirting out of aluminium, L- + j-form | | | | | | | |
| Bitte bei Bestellung immer Winkel, 94° oder 135°, angeben! Please specify when ordering the number of degrees of tilt with 94° or 135°! | | | | | | | |
| AxBxC mm | L / l (m) | selbstkl./ self-adhesive | €/m | gebohrt/ drilled | €/m | ohne alles/ bare | €/m |

Abkant-Sockelleiste, Aluminium, gekantet auf 94° oder 135°

edged skirting, **461**
aluminium,
94° or 135°

Bitte bei Bestellung die genaue Gradzahl angeben! Please specify the exact number of degrees when ordering!

| | | | | | | | | |
|--|---------------|------|---------|---------|---------|---------|---------|---------|
| silber elox. silver anodized | 40 x 10 x 1,0 | 2,5 | 69024-5 | 12,40/m | 69034-4 | 11,14/m | 69044-3 | 9,42/m |
| | 40 x 20 x 1,0 | 2,5 | 69026-9 | 12,78/m | 69036-8 | 11,54/m | 69046-7 | 9,80/m |
| | 40 x 10 x 2,0 | 2,5 | 69028-3 | 19,22/m | 69038-2 | 17,98/m | 69048-1 | 16,24/m |
| | 40 x 20 x 2,0 | 2,5 | 69030-6 | 19,94/m | 69040-5 | 18,70/m | 69050-4 | 16,98/m |
| edelstahl- farbig stainless steel coloured | 40 x 10 x 1,0 | 2,5* | 69054-2 | 14,14/m | 69064-1 | 12,90/m | 69074-0 | 11,16/m |
| | 40 x 20 x 1,0 | 2,5* | 69056-6 | 14,64/m | 69066-5 | 13,40/m | 69076-4 | 11,66/m |
| | 40 x 10 x 2,0 | 2,5* | 69058-0 | 21,06/m | 69068-9 | 19,80/m | 69078-8 | 18,08/m |
| | 40 x 20 x 2,0 | 2,5* | 69060-3 | 21,84/m | 69070-2 | 20,60/m | 69080-1 | 18,86/m |
| Pulvern n. RAL/ powder RAL (Preis ab 150 lfm./ price from 150 m) | 40 x 10 x 1,0 | 2,5 | 69084-9 | 20,30/m | 69094-8 | 19,08/m | 69104-4 | 17,32/m |
| | 40 x 20 x 1,0 | 2,5 | 69086-3 | 20,70/m | 69096-2 | 19,46/m | 69106-8 | 17,72/m |
| | 40 x 10 x 2,0 | 2,5 | 69088-7 | 27,14/m | 69098-6 | 25,88/m | 69108-2 | 24,16/m |
| | 40 x 20 x 2,0 | 2,5 | 69090-0 | 27,86/m | 69100-6 | 26,62/m | 69110-5 | 24,88/m |
| Pulvern nach RAL unter 150 lfm. auf Anfrage powdered (RAL) less than 150 m on request | | | | | | | | |

HÖHE/ height
40 mm



292

293

HÖHE/ height
50 mm

Abkantung mit Dach, um alte Sockelleisten zu überdecken, auf Anfrage erhältlich
edged with a roof to cover old skirtings, available on request



296

294

297

295

HÖHE/ height
60 mm

* inklusive 40 mm Klemmstelle an einer Seite vom Eloxieren/ including 40 mm clamping point on one side by anodizing

| | | | | | | | | |
|--|---------------|------|---------|---------|---------|---------|---------|---------|
| silber elox. silver anodized | 50 x 10 x 1,0 | 2,5 | 69662-9 | 13,22/m | 69676-6 | 12,00/m | 69690-2 | 10,24/m |
| | 50 x 20 x 1,0 | 2,5 | 65000-3 | 13,40/m | 65006-5 | 12,00/m | 65012-6 | 10,40/m |
| | 50 x 10 x 2,0 | 2,5 | 69664-3 | 20,70/m | 69678-0 | 19,46/m | 69692-6 | 17,72/m |
| | 50 x 20 x 2,0 | 2,5 | 65020-1 | 21,00/m | 65026-3 | 19,60/m | 65032-4 | 18,00/m |
| edelstahl- farbig stainless steel coloured | 50 x 10 x 1,0 | 2,5* | 69666-7 | 15,14/m | 69680-3 | 13,94/m | 69694-0 | 12,18/m |
| | 50 x 20 x 1,0 | 2,5* | 65002-7 | 15,40/m | 65008-9 | 13,98/m | 65014-0 | 12,40/m |
| | 50 x 10 x 2,0 | 2,5* | 69668-1 | 22,68/m | 69682-7 | 21,44/m | 69696-4 | 19,70/m |
| | 50 x 20 x 2,0 | 2,5* | 65022-5 | 22,98/m | 65028-7 | 21,58/m | 65034-8 | 20,02/m |
| Pulvern n. RAL/ powder RAL (Preis ab 150 lfm./ price from 150 m) | 50 x 10 x 1,0 | 2,5 | 69670-4 | 21,50/m | 69684-1 | 20,24/m | 69698-8 | 18,52/m |
| | 50 x 20 x 1,0 | 2,5 | 65004-1 | 21,78/m | 65010-2 | 20,36/m | 65016-4 | 18,80/m |
| | 50 x 10 x 2,0 | 2,5 | 69672-8 | 29,00/m | 69686-5 | 27,76/m | 69700-8 | 26,02/m |
| | 50 x 20 x 2,0 | 2,5 | 65024-9 | 29,40/m | 65030-0 | 27,96/m | 65036-2 | 26,42/m |
| Pulvern nach RAL unter 150 lfm. auf Anfrage powdered (RAL) less than 150 m on request | | | | | | | | |

| | | | | | | | | |
|--|---------------|------|---------|---------|---------|---------|---------|---------|
| silber elox. silver anodized | 60 x 10 x 1,0 | 2,5 | 65080-5 | 13,40/m | 65086-7 | 12,00/m | 65092-8 | 10,40/m |
| | 60 x 20 x 1,0 | 2,5 | 65040-9 | 14,20/m | 65046-1 | 12,76/m | 65052-2 | 11,18/m |
| | 60 x 10 x 2,0 | 2,5 | 65100-0 | 21,00/m | 65106-2 | 19,60/m | 65112-3 | 18,00/m |
| | 60 x 20 x 2,0 | 2,5 | 65060-7 | 22,98/m | 65066-9 | 21,58/m | 65072-0 | 20,02/m |
| edelstahl- farbig stainless steel coloured | 60 x 10 x 1,0 | 2,5* | 65082-9 | 15,40/m | 65088-1 | 13,98/m | 65094-2 | 12,40/m |
| | 60 x 20 x 1,0 | 2,5* | 65042-3 | 16,22/m | 65048-5 | 14,74/m | 65054-6 | 13,20/m |
| | 60 x 10 x 2,0 | 2,5* | 65102-4 | 22,98/m | 65108-6 | 21,58/m | 65114-7 | 20,02/m |
| | 60 x 20 x 2,0 | 2,5* | 65062-1 | 24,96/m | 65068-3 | 23,58/m | 65074-4 | 22,02/m |
| Pulvern n. RAL/ powder RAL (Preis ab 150 lfm./ price from 150 m) | 60 x 10 x 1,0 | 2,5 | 65084-3 | 21,78/m | 65090-4 | 20,36/m | 65096-6 | 18,80/m |
| | 60 x 20 x 1,0 | 2,5 | 65044-7 | 22,62/m | 65050-8 | 21,16/m | 65056-0 | 19,62/m |
| | 60 x 10 x 2,0 | 2,5 | 65104-8 | 29,40/m | 65110-9 | 27,96/m | 65116-1 | 26,42/m |
| | 60 x 20 x 2,0 | 2,5 | 65064-5 | 31,38/m | 65070-6 | 29,94/m | 65076-8 | 28,42/m |
| Pulvern nach RAL unter 150 lfm. auf Anfrage powdered (RAL) less than 150 m on request | | | | | | | | |

Anfertigung von passenden Innen- und Außenecken siehe Seite 113 - Lieferzeit nach Vereinbarung
production of matching corners see page 113 - delivery time by prior arrangement

8. SOCKELLEISTEN/ 8. SKIRTINGS

Andere Abmaße auf Anfrage/ other dimensions on demand

Lieferzeit für Pulverbeschichtung auf Anfrage
delivery time for powder coating on request

| Abkant-Sockelleiste Aluminium, L- & j-Form | | | | | | | |
|--|-----------|-----------------------------|-----|---------------------|-----|---------------------|-----|
| edged skirting out of aluminium, L- + j-form | | | | | | | |
| Bitte bei Bestellung immer Winkel, 94° oder 135°, angeben! Please specify when ordering the number of degrees of tilt with 94° or 135°! | | | | | | | |
| AxBxC mm | L / l (m) | selbstkl./ self-adhesive | €/m | gebohrt/ drilled | €/m | ohne alles/ bare | €/m |

Abkant-Sockelleiste, Aluminium, gekantet auf 94° oder 135°

edged skirting, aluminium, 94° or 135°

Bitte bei Bestellung die genaue Gradzahl angeben!
Please specify the exact number of degrees when ordering!

| | | | | | | | | |
|--|---------------|------|---------|---------|---------|---------|---------|---------|
| silber elox. silver anodized | 80 x 10 x 1,0 | 2,5 | 69114-3 | 16,26/m | 69124-2 | 15,04/m | 69134-1 | 13,28/m |
| | 80 x 20 x 1,0 | 2,5 | 69116-7 | 17,74/m | 69126-6 | 16,54/m | 69136-5 | 14,76/m |
| | 80 x 10 x 2,0 | 2,5 | 69118-1 | 29,58/m | 69128-0 | 28,32/m | 69138-9 | 26,60/m |
| | 80 x 20 x 2,0 | 2,5 | 69120-4 | 32,50/m | 69130-3 | 31,28/m | 69140-2 | 29,52/m |
| edelstahl- farbig stainless steel coloured | 80 x 10 x 1,0 | 2,5* | 69144-0 | 19,50/m | 69154-9 | 18,26/m | 69164-8 | 16,54/m |
| | 80 x 20 x 1,0 | 2,5* | 69146-4 | 20,88/m | 69156-3 | 19,64/m | 69166-2 | 17,90/m |
| | 80 x 10 x 2,0 | 2,5* | 69148-8 | 32,80/m | 69158-7 | 31,54/m | 69168-6 | 29,82/m |
| | 80 x 20 x 2,0 | 2,5* | 69150-1 | 35,72/m | 69160-0 | 34,50/m | 69170-9 | 32,78/m |
| Pulvern n. RAL/ powder RAL (Preis ab 150 lfm./ price from 150 m) | 80 x 10 x 1,0 | 2,5 | 69174-7 | 24,70/m | 69184-6 | 23,44/m | 69194-5 | 21,72/m |
| | 80 x 20 x 1,0 | 2,5 | 69176-1 | 26,18/m | 69186-0 | 24,92/m | 69196-9 | 23,20/m |
| | 80 x 10 x 2,0 | 2,5 | 69178-5 | 37,98/m | 69188-4 | 36,76/m | 69198-3 | 35,00/m |
| | 80 x 20 x 2,0 | 2,5 | 69180-8 | 40,94/m | 69190-7 | 39,70/m | 69200-3 | 37,96/m |
| Pulvern nach RAL unter 150 lfm. auf Anfrage powdered (RAL) less than 150 m on request | | | | | | | | |

HÖHE/ height
80 mm

462

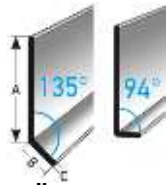

HÖHE/ height
100 mm

463

| | | | | | | | | |
|---|----------------|------|---------|---------|---------|---------|---------|---------|
| silber elox. silver anodized | 100 x 10 x 1,0 | 2,5 | 69204-1 | 19,22/m | 69214-0 | 17,98/m | 69224-9 | 16,24/m |
| | 100 x 20 x 1,0 | 2,5 | 69206-5 | 20,70/m | 69216-4 | 19,46/m | 69226-3 | 17,72/m |
| | 100 x 10 x 2,0 | 2,5 | 69208-9 | 35,46/m | 69218-8 | 34,22/m | 69228-7 | 32,48/m |
| | 100 x 20 x 2,0 | 2,5 | 69210-2 | 38,44/m | 69220-1 | 37,20/m | 69230-0 | 35,46/m |
| edelstahl- farbig stainless steel coloured | 100 x 10 x 1,0 | 2,5* | 69234-8 | 22,92/m | 69244-7 | 21,70/m | 69254-6 | 19,96/m |
| | 100 x 20 x 1,0 | 2,5* | 69236-2 | 24,40/m | 69246-1 | 23,18/m | 69256-0 | 21,44/m |
| | 100 x 10 x 2,0 | 2,5* | 69238-6 | 39,20/m | 69248-5 | 37,94/m | 69258-4 | 36,22/m |
| | 100 x 20 x 2,0 | 2,5* | 69240-9 | 42,12/m | 69250-8 | 40,92/m | 69260-7 | 39,20/m |

* inklusive 40mm
Klemmstelle an
einer Seite vom
Eloxieren/ including
40 mm clamping
point on one side
by anodizing

| | | | | | | | | |
|--|----------------|-----|---------|---------|---------|---------|---------|---------|
| Pulvern n. RAL/ powder RAL (Preis ab 150 lfm./ price from 150 m) | 100 x 10 x 1,0 | 2,5 | 69264-5 | 28,14/m | 69274-4 | 26,88/m | 69284-3 | 25,16/m |
| | 100 x 20 x 1,0 | 2,5 | 69266-9 | 29,62/m | 69276-8 | 28,36/m | 69286-7 | 26,64/m |
| | 100 x 10 x 2,0 | 2,5 | 69268-3 | 44,38/m | 69278-2 | 43,12/m | 69288-1 | 41,40/m |
| | 100 x 20 x 2,0 | 2,5 | 69270-6 | 47,36/m | 69280-5 | 46,10/m | 69290-4 | 44,38/m |
| Pulvern nach RAL unter 150 lfm. auf Anfrage powdered (RAL) less than 150 m on request | | | | | | | | |

Anfertigung von passenden Innen- und Außenecken siehe Seite 113 - Lieferzeit nach Vereinbarung
production of matching corners see page 113 - delivery time by prior arrangement

Abkantung mit Dach, um alte Sockelleisten zu überdecken, auf Anfrage erhältlich

edged with a roof to cover old skirtings, available on request



Aluminium-Einklebe-Sockelleiste für 3 mm-Beläge

aluminium skirting for 3 mm flooring

| Farbe/colour | L / l (m) | Art./ref. | €/m |
|--------------|-----------|-----------|-----|
|--------------|-----------|-----------|-----|

310 DESIGN-Einklebe-Sockelleiste 60 x 10 x 3,2 mm für Beläge bis 3 mm, Alu elox., gebohrt

DESIGN skirting 60 x 10 x 3,2 mm for bonding floor to 3 mm, aluminium anodized, drilled



| | | | |
|--|-----|---------|---------|
| silber eloxiert silver anodized | 2,5 | 44524-1 | 15,74/m |
| edelstahlfarbig/ AL-INOX stainless steel coloured | 2,5 | 44532-6 | 17,48/m |

Pulverbeschichtet? Selbstklebend? Sonderlängen? Auf Anfrage erhältlich.

Powdered (RAL)? Self-adhesive? Special length cuts? Available on demand.

8. SOCKELLEISTEN/ 8. SKIRTINGS

Lieferzeit für
Pulverbeschichtung
auf Anfrage/ delivery
time for powder coating
on request

| Aluminium-Sockelleiste Typ L40/50/60/80/100, stranggepresst | | | | | | | |
|--|-----------|-----------------------------|-----|---------------------|-----|---------------------|-----|
| aluminium skirting type L40/50/60/80/100, extruded | | | | | | | |
| Selbstklebende Sockelleisten zusätzlich punktweise mit Montagekleber befestigen! Please fasten self-adhesive skirtings also with dots of builders adhesive! | | | | | | | |
| Farbe/colour | L / l (m) | selbstkl./ self-adhesive | €/m | gebohrt/ drilled | €/m | ohne alles/ bare | €/m |

Aluminium-Sockelleiste, TYP L, stranggepresst/ aluminium skirting, type L, extruded

40 x 10 x 1,4 mm

156

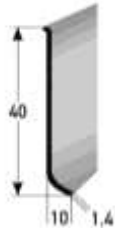

| | | | | | | | |
|--|-----|---------|---------|---------|---------|---------|---------|
| silber elox. silver anodized | 2,5 | 44000-0 | 11,02/m | 44004-8 | 9,70/m | 44008-6 | 8,00/m |
| edelstahlfarb. Feinschliff fine-honed stainless steel col. | 2,5 | 44036-9 | 13,22/m | 44040-6 | 12,42/m | 44044-4 | 10,20/m |
| Pulvern n. RAL; Preis ab 150 lfm. powder RAL; price from 150 m | 2,5 | 44018-5 | 20,06/m | 44022-2 | 17,92/m | 44026-0 | 15,06/m |
| Pulvern nach RAL unter 150 lfm. auf Anfrage powdered (RAL) less than 150 m on request | | | | | | | |

50 x 10 x 1,4 mm

157

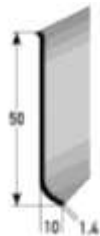

| | | | | | | | |
|--|-----|---------|---------|---------|---------|---------|---------|
| silber elox. silver anodized | 2,5 | 44056-7 | 12,14/m | 44060-4 | 10,90/m | 44064-2 | 9,26/m |
| edelstahlfarb. Feinschliff fine-honed stainless steel col. | 2,5 | 44092-5 | 14,16/m | 44096-3 | 13,34/m | 44100-7 | 11,14/m |
| Pulvern n. RAL; Preis ab 150 lfm. powder RAL; price from 150 m | 2,5 | 44074-1 | 21,88/m | 44078-9 | 19,70/m | 44082-6 | 16,84/m |
| Pulvern nach RAL unter 150 lfm. auf Anfrage powdered (RAL) less than 150 m on request | | | | | | | |

60 x 10 x 1,5 mm

158



| | | | | | | | |
|--|-----|---------|---------|---------|---------|---------|---------|
| silber elox. silver anodized | 2,5 | 44112-0 | 13,34/m | 44116-8 | 12,12/m | 44120-5 | 10,56/m |
| edelstahlfarb. Feinschliff fine-honed stainless steel col. | 2,5 | 44148-9 | 15,64/m | 44152-6 | 14,84/m | 44156-4 | 12,62/m |
| Pulvern n. RAL; Preis ab 150 lfm. powder RAL; price from 150 m | 2,5 | 44130-4 | 23,96/m | 44134-2 | 21,78/m | 44138-0 | 18,92/m |
| Pulvern nach RAL unter 150 lfm. auf Anfrage powdered (RAL) less than 150 m on request | | | | | | | |

80 x 10 x 1,5 mm

159

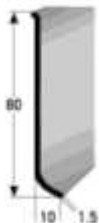

| | | | | | | | |
|--|-----|---------|---------|---------|---------|---------|---------|
| silber elox. silver anodized | 2,5 | 44168-7 | 16,62/m | 44172-4 | 15,28/m | 44176-2 | 13,64/m |
| edelstahlfarb. Feinschliff fine-honed stainless steel col. | 2,5 | 44204-2 | 18,46/m | 44208-0 | 16,98/m | 44212-7 | 14,66/m |
| Pulvern n. RAL; Preis ab 150 lfm. powder RAL; price from 150 m | 2,5 | 44186-1 | 28,72/m | 44190-8 | 26,60/m | 44194-6 | 23,74/m |
| Pulvern nach RAL unter 150 lfm. auf Anfrage powdered (RAL) less than 150 m on request | | | | | | | |

100 x 10 x 1,7 mm

569



| | | | | | | | |
|--|-----|---------|---------|---------|---------|---------|---------|
| silber elox. silver anodized | 2,5 | 72526-8 | 18,84/m | 72532-9 | 17,54/m | 72538-1 | 15,96/m |
| edelstahlfarb. Feinschliff fine-honed stainless steel col. | 2,5 | 72528-2 | 19,98/m | 72534-3 | 18,68/m | 72540-4 | 17,10/m |
| Pulvern n. RAL; Preis ab 150 lfm. powder RAL; price from 150 m | 2,5 | 72530-5 | 28,44/m | 72536-7 | 27,14/m | 72542-8 | 25,56/m |
| Pulvern nach RAL unter 150 lfm. auf Anfrage powdered (RAL) less than 150 m on request | | | | | | | |



8. SOCKELLEISTEN/ 8. SKIRTINGS

Druckguss-Zubehör für Aluminium-Sockelleiste Typen L40 - L100

diecast accessories for aluminium skirting types L40 - L100

| Farbe/colour | Art./ref. | €/Stk./ pcs. | Art./ref. | €/Stk./ pcs. | Art./ref. | €/Stk./ pcs. | Art./ref. | €/Stk./ pcs. |
|--------------|-----------|--------------|-----------|--------------|-----------|--------------|-----------|--------------|
|--------------|-----------|--------------|-----------|--------------|-----------|--------------|-----------|--------------|

570 Aussenecke für L-Sockelleisten, Druckguss

outside corner for L-skirtings, diecast



| | L40 | | L60 | | L80 | | L100 | |
|---------------------------------|---------|-------|---------|-------|---------|-------|---------|-------|
| silber elox. silver anodized | 72372-1 | 9,40 | 72392-9 | 11,28 | 72412-4 | 13,18 | 72432-2 | 15,06 |
| Pulvern n. RAL powder RAL | 72374-5 | 15,16 | 72394-3 | 17,06 | 72414-8 | 18,94 | 72434-6 | 20,84 |

571 Innenecke für L-Sockelleisten, Druckguss

inside corner for L-skirtings, diecast



| | L40 | | L60 | | L80 | | L100 | |
|---------------------------------|---------|-------|---------|-------|---------|-------|---------|-------|
| silber elox. silver anodized | 72376-9 | 9,40 | 72396-7 | 11,28 | 72416-2 | 13,18 | 72436-0 | 15,06 |
| Pulvern n. RAL powder RAL | 72378-3 | 15,16 | 72398-1 | 17,06 | 72418-6 | 18,94 | 72438-4 | 20,84 |

572 Verbinder für L-Sockelleisten, Druckguss

connecting piece for L-skirtings, diecast



| | L40 | | L60 | | L80 | | L100 | |
|---------------------------------|---------|-------|---------|-------|---------|-------|---------|-------|
| silber elox. silver anodized | 72380-6 | 4,68 | 72400-1 | 5,76 | 72420-9 | 6,86 | 72440-7 | 7,96 |
| Pulvern n. RAL powder RAL | 72382-0 | 10,44 | 72402-5 | 11,54 | 72422-3 | 12,62 | 72442-1 | 13,72 |

573 Endstück LINKS für L-Sockelleisten, Druckguss

left end cap for L-skirtings, diecast



| | L40 | | L60 | | L80 | | L100 | |
|---------------------------------|---------|-------|---------|-------|---------|-------|---------|-------|
| silber elox. silver anodized | 72384-4 | 4,68 | 72404-9 | 5,76 | 72424-7 | 6,86 | 72444-5 | 7,96 |
| Pulvern n. RAL powder RAL | 72386-8 | 10,44 | 72406-3 | 11,54 | 72426-1 | 12,62 | 72446-9 | 13,72 |

574 Endstück RECHTS für L-Sockelleisten, Druckguss

right end cap for L-skirtings, diecast



| | L40 | | L60 | | L80 | | L100 | |
|---------------------------------|---------|-------|---------|-------|---------|-------|---------|-------|
| silber elox. silver anodized | 72388-2 | 4,68 | 72408-7 | 5,76 | 72428-5 | 6,86 | 72448-3 | 7,96 |
| Pulvern n. RAL powder RAL | 72390-5 | 10,44 | 72410-0 | 11,54 | 72430-8 | 12,62 | 72450-6 | 13,72 |

8. SOCKELLEISTEN/ 8. SKIRTINGS

Zubehör für Aluminium-Sockelleiste Typen L40 - L100; VE à 10 Stück

accessories for aluminium skirting types L40 - L100; professional packing à 10 pcs.

| Farbe/colour | Art./ref. | €/Stk./ pcs. | Art./ref. | €/Stk./ pcs. | Art./ref. | €/Stk./ pcs. | Art./ref. | €/Stk./ pcs. | Art./ref. | €/Stk./ pcs. |
|--------------|-----------|-----------------|-----------|-----------------|-----------|-----------------|-----------|-----------------|-----------|-----------------|
|--------------|-----------|-----------------|-----------|-----------------|-----------|-----------------|-----------|-----------------|-----------|-----------------|

160 Aussenecke für L-Sockelleisten, fein geschweißt

outside corner,
finely welded



| | L40 | L50 | L60 | L80 | L100 |
|--|---------------|---------------|---------------|---------------|---------------|
| silber elox. silver anodized | 44232-5 8,00 | 44294-3 9,26 | 44356-8 ##### | 44418-3 ##### | 72454-4 16,74 |
| edelstahlfarbig Feinschliff fine-honed stainless steel coloured | 44228-8 9,12 | 44290-5 ##### | 44352-0 ##### | 44414-5 ##### | 72456-8 19,20 |
| Pulvern n. RAL powder RAL | 44230-1 ##### | 44292-9 ##### | 44354-4 ##### | 44416-9 ##### | 72458-2 22,82 |



161 Innenecke für L-Sockelleisten, fein geschweißt

inside corner,
finely welded

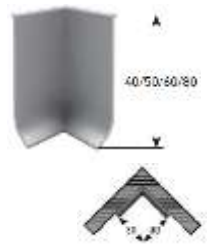

| | L40 | L50 | L60 | L80 | L100 |
|--|---------------|---------------|---------------|---------------|---------------|
| silber elox. silver anodised | 44238-7 8,00 | 44300-1 9,26 | 44362-9 ##### | 44424-4 ##### | 72460-5 16,74 |
| edelstahlfarbig Feinschliff fine-honed stainless steel coloured | 44234-9 9,12 | 44296-7 ##### | 44358-2 ##### | 44420-6 ##### | 72462-9 19,20 |
| Pulvern n. RAL powder RAL | 44236-3 ##### | 44298-1 ##### | 44360-5 ##### | 44422-0 ##### | 72464-3 22,82 |



162 Treppenecke hinten, Sockelleiste + 20 mm Auflagemaß, für L-Sockel., fein geschweißt

stair corner rear,
skirting + 20 mm
flange, finely welded



| | L40 | L50 | L60 | L80 | L100 |
|--|---------------|---------------|---------------|---------------|---------------|
| silber elox. silver anodised | 44244-8 8,00 | 44306-3 9,26 | 44368-1 ##### | 44430-5 ##### | 72466-7 16,74 |
| edelstahlfarbig Feinschliff fine-honed stainless steel coloured | 44240-0 9,12 | 44302-5 ##### | 44364-3 ##### | 44426-8 ##### | 72468-1 19,20 |
| Pulvern n. RAL powder RAL | 44242-4 ##### | 44304-9 ##### | 44366-7 ##### | 44428-2 ##### | 72470-4 22,82 |

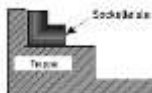

163 Treppenecke vorn, 20 x 20 mm Auflagemaß, für L-Sockelleisten, fein geschweißt

stair corner front,
20 x 20 mm flange,
finely welded



| | L40 | L50 | L60 | L80 | L100 |
|--|---------------|---------------|---------------|---------------|---------------|
| silber elox. silver anodised | 44250-9 8,00 | 44312-4 9,26 | 44374-2 ##### | 44436-7 ##### | 72472-8 16,74 |
| edelstahlfarbig Feinschliff fine-honed stainless steel coloured | 44246-2 9,12 | 44308-7 ##### | 44370-4 ##### | 44432-9 ##### | 72474-2 19,20 |
| Pulvern n. RAL powder RAL | 44248-6 ##### | 44310-0 ##### | 44372-8 ##### | 44434-3 ##### | 72476-6 22,82 |



Aufschlag für selbstklebende Ausführung für eine Seite
(für 2. Seite Montagekleber verwenden)

extra for self-adhesive version for one side only (use builders adhesive for 2nd side)

| Art./ref. | €/Stk./ pcs. |
|-----------|-----------------|
| 44222-6 | 1,36 |

Pulverbeschichtung erfolgt nur im Zusammenhang mit pulverbeschichteten Sockelleisten! Lieferzeit auf Anfrage.

Powder coating only when ordering powder coated skirtings! Delivery time on request.

8. SOCKELLEISTEN/ 8. SKIRTINGS

Andere Abmaße und Farben auf Anfrage/
other dimensions and colours on demand

464 Einklebe-Sockelleiste Aluminium silber eloxiert, gekantet
aluminium skirting for bonding flooring, silver anodized, edged



| Einklebe-Sockelleiste Aluminium silber eloxiert, gekantet, TYP r-Form | | | | | | | | |
|---|-----------|-------------------------|---------|-----------------|---------|-----------------|---------|--|
| aluminium skirtings for bonding flooring, edged, type r-form | | | | | | | | |
| AxBxC mm | L / l (m) | selbstkl./self-adhesive | €/m | gebohrt/drilled | €/m | ohne alles/bare | €/m | |
| 40 x 4 x 1,0 | 2,5 | 69294-2 | 12,32/m | 69302-4 | 11,10/m | 69310-9 | 9,38/m | |
| 40 x 6 x 1,0 | 2,5 | 69296-6 | 12,40/m | 69304-8 | 11,14/m | 69312-3 | 9,42/m | |
| 40 x 11 x 1,0 | 2,5 | 69298-0 | 12,50/m | 69306-2 | 11,26/m | 69314-7 | 9,54/m | |
| 50 x 4 x 1,0 | 2,5 | 69318-5 | 13,20/m | 69326-0 | 11,96/m | 69334-5 | 10,22/m | |
| 50 x 6 x 1,0 | 2,5 | 69320-8 | 13,24/m | 69328-4 | 12,02/m | 69336-9 | 10,26/m | |
| 50 x 11 x 1,0 | 2,5 | 69322-2 | 13,36/m | 69330-7 | 12,12/m | 69338-3 | 10,40/m | |
| 60 x 4 x 1,0 | 2,5 | 69342-0 | 13,34/m | 69350-5 | 12,10/m | 69358-1 | 10,38/m | |
| 60 x 6 x 1,0 | 2,5 | 69344-4 | 13,40/m | 69352-9 | 12,14/m | 69360-4 | 10,42/m | |
| 60 x 11 x 1,0 | 2,5 | 69346-8 | 13,54/m | 69354-3 | 12,28/m | 69362-8 | 10,56/m | |
| 80 x 4 x 1,0 | 2,5 | 69366-6 | 16,28/m | 69374-1 | 15,06/m | 69382-6 | 13,32/m | |
| 80 x 6 x 1,0 | 2,5 | 69368-0 | 16,34/m | 69376-5 | 15,10/m | 69384-0 | 13,36/m | |
| 80 x 11 x 1,0 | 2,5 | 69370-3 | 16,46/m | 69378-9 | 15,24/m | 69386-4 | 13,52/m | |
| 100 x 4 x 1,5 | 2,5 | 69390-1 | 19,08/m | 69398-7 | 17,82/m | 69406-9 | 16,10/m | |
| 100 x 6 x 1,5 | 2,5 | 69392-5 | 19,20/m | 69400-7 | 17,96/m | 69408-3 | 16,22/m | |
| 100 x 11 x 1,5 | 2,5 | 69394-9 | 19,38/m | 69402-1 | 18,14/m | 69410-6 | 16,40/m | |

Lieferzeit für Pulverbeschichtung auf Anfrage/
delivery time for powder coating on request

518

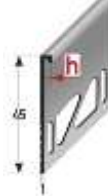

Einklebe-Sockelleiste 45 x h=2,5 mm, Alu., stranggepresst, mit Fliesenstanzung

skirting 45 x h=2,5 mm for bonding flooring, aluminium, extruded, with triangular punching

| Einklebe-Sockelleisten Aluminium, stranggepresst | | | | | | | | |
|--|-----------|---------------------|-----|-----------------|-----|-----------------|--------|--|
| aluminium skirtings for bonding flooring, extruded | | | | | | | | |
| Farbe/colour | L / l (m) | selbstklebend/self- | €/m | gebohrt/drilled | €/m | ohne alles/bare | €/m | |
| Alu. pressblank aluminium mill-finish | 2,7 | - | - | - | - | 72250-2 | 5,20/m | |

380

Einklebe-Sockelleiste 60 x 3 mm, Aluminium, stranggepresst

skirting 60 x 3 mm for bonding flooring, aluminium, extruded



| | | | | | | | | |
|--|---|---------|---------|---------|---------|---------|---------|--|
| silber elox. silver anodised | 2,5 | 66494-9 | 14,22/m | 66496-3 | 12,80/m | 66498-7 | 11,20/m | |
| edelstahlfarbig stainless steel coloured | 2,5 | 66500-7 | 15,96/m | 66502-1 | 14,52/m | 66504-5 | 12,94/m | |
| Pulvern n. RAL/ powder RAL | 2,5 | 66506-9 | 20,20/m | 66508-3 | 18,76/m | 66510-6 | 17,18/m | |
| Preis ab 150 lfm./ price from 150 m | Pulvern nach RAL unter 150 lfm. auf Anfrage powdered (RAL) less than 150 m on request | | | | | | | |

381

Einklebe-Sockelleiste 60 x 5 mm, Aluminium, stranggepresst

skirting 60 x 5 mm for bonding flooring, aluminium, extruded



| | | | | | | | | |
|--|---|---------|---------|---------|---------|---------|---------|--|
| silber elox. silver anodised | 2,5 | 66514-4 | 14,60/m | 66516-8 | 13,18/m | 66518-2 | 11,58/m | |
| edelstahlfarbig stainless steel coloured | 2,5 | 66520-5 | 16,36/m | 66522-9 | 14,94/m | 66524-3 | 13,34/m | |
| Pulvern n. RAL/ powder RAL | 2,5 | 66526-7 | 20,58/m | 66528-1 | 19,14/m | 66530-4 | 17,56/m | |
| Preis ab 150 lfm./ price from 150 m | Pulvern nach RAL unter 150 lfm. auf Anfrage powdered (RAL) less than 150 m on request | | | | | | | |

382

Einklebe-Sockelleiste 60 x 11 mm, Aluminium, stranggepresst

skirting 60 x 11 mm for bonding flooring, aluminium, extruded



| | | | | | | | | |
|--|---|---------|---------|---------|---------|---------|---------|--|
| silber elox. silver anodised | 2,5 | 66534-2 | 15,60/m | 66536-6 | 14,18/m | 66538-0 | 12,60/m | |
| edelstahlfarbig stainless steel coloured | 2,5 | 66540-3 | 17,56/m | 66542-7 | 16,12/m | 66544-1 | 14,54/m | |
| Pulvern n. RAL/ powder RAL | 2,5 | 66546-5 | 21,58/m | 66548-9 | 20,16/m | 66550-2 | 18,56/m | |
| Preis ab 150 lfm./ price from 150 m | Pulvern nach RAL unter 150 lfm. auf Anfrage powdered (RAL) less than 150 m on request | | | | | | | |

Anfertigung von passenden Innen- und Außenecken siehe Seite 113 - Lieferzeit nach Vereinbarung
production of matching corners see page 113 - delivery time by prior arrangement

8. SOCKELLEISTEN/ 8. SKIRTINGS

CONTEGO-Sockelleiste aus Aluminium, VE = 5 Stück

CONTEGO skirting out of aluminium, unit = 5 pcs.

| Farbe/colour | AxB mm | L / l (m) | Art./ref. | €/m |
|--------------|--------|-----------|-----------|-----|
|--------------|--------|-----------|-----------|-----|

465 CONTEGO-Sockelleiste Aluminum, ohne Befestigungszubehör

CONTEGO skirting
aluminum

ohne Befestigungszubehör
without fixing items

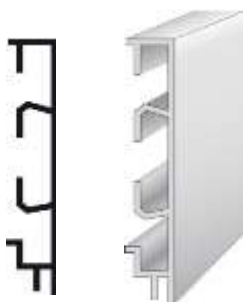

| | | | | |
|---|--|-----|---------|-----------|
| silber elox. silver anodized | 40 x 11 | 2,5 | 69416-8 | 15,32 €/m |
| | 60 x 11 | 2,5 | 69418-2 | 19,02 €/m |
| | 60 x 15 | 2,5 | 69420-5 | 21,76 €/m |
| | 100 x 11 | 2,5 | 69422-9 | 26,30 €/m |
| Pulvern n. RAL/ powder RAL (Preis ab 150 lfm./ price from 150 m) | 40 x 11 | 2,5 | 69436-6 | 23,74 €/m |
| | 60 x 11 | 2,5 | 69438-0 | 27,42 €/m |
| | 60 x 15 | 2,5 | 69440-3 | 30,20 €/m |
| | 100 x 11 | 2,5 | 69442-7 | 39,50 €/m |
| | Pulvern nach RAL unter 150 lfm. auf Anfrage powdered (RAL) less than 150 m on request | | | |

auf Anfrage gebohrt erhältlich
drilled on request

Dieses Profil kann mit Montagekleber geklebt, mit Befestigungsclips (siehe Profil-
nr. 466) geclipst, oder auf Anfrage auch gebohrt werden zur Befestigung mit
Schrauben und Dübel. / This profile can be glued with builders adhesive, clipped with fixing clips (see
profile no. 466), or be drilled on request for fixing with screws and dowels.

Lieferzeit für Pulverbeschichtung auf Anfrage / delivery time for powder coating on request

Zubehör für CONTEGO-Sockelleiste

accessories for CONTEGO skirting

466 Befestigungsclip inkl. Schrauben & Dübel für Contego-Sockelleiste

fixing clip with screws and dowels
for CONTEGO skirting

Für eine Contego-Sockelleiste à 2,5 m
empfehlen wir 6 Befestigungsclips.
For Contego skirting à 2,5 m we
recommend 6 fixing clips.



| Abpackung/ unit | Art./ref. | € |
|------------------------------|-----------|--------|
| à 1 Stk./pcs. | 69446-5 | 2,70 |
| Kart./box à 100 Stk./pcs. | 69447-2 | 236,34 |

467 Abdichtlippe für Contego-Sockelleiste, Silikon metallicfarben

rubber lip for CONTEGO skirting,
silicone metallic coloured



| L / l (m) | Art./ref. | € |
|-----------------------|-----------|-------------|
| Rolle/ roll à 20 m | 69450-2 | 93,08 €/Ro. |

Für Zuschnitte erheben wir einen Arbeitsaufschlag von 15 %/
For cuttings we charge a labor surcharge of 15%.

8. SOCKELLEISTEN/ 8. SKIRTINGS

**Lieferzeit für
 Pulverbeschichtung auf
 Anfrage / delivery time for powder
 coating on request**

| Zubehör für CONTEGO-Sockelleiste | | | | |
|----------------------------------|---------|-------------------------------|-----------|-------------|
| accessories for CONTEGO skirting | | | | |
| Farbe/colour | VE/unit | für Größe/ for size AxB mm | Art./ref. | €/Stk./pcs. |

468 Innenecke für CONTEGO-Sockelleiste, Aluminiumguss

inside corner for CONTEGO
 skirting, aluminum casting



| | | | | |
|---|-----------------|----------|---------|-------|
| silberfarbig silver coloured | 10 Stk./pcs. | 40 x 11 | 69456-4 | 22,72 |
| | | 60 x 11 | 69458-8 | 22,72 |
| | | 60 x 15 | 69460-1 | 23,96 |
| | | 100 x 11 | 69462-5 | 26,68 |
| nach RAL to RAL | 10 Stk./pcs. | 40 x 11 | 69476-2 | 26,68 |
| | | 60 x 11 | 69478-6 | 26,68 |
| | | 60 x 15 | 69480-9 | 27,92 |
| | | 100 x 11 | 69482-3 | 30,66 |
| Nur im Zusammenhang mit pulverbeschichteten Sockelleisten möglich! Only possible when ordering powder coated skirtings! | | | | |

469 Außenecke für CONTEGO-Sockelleiste, Aluminiumguss

outside corner for CONTEGO
 skirting, aluminum casting



| | | | | |
|---|-----------------|----------|---------|-------|
| silberfarbig silver coloured | 10 Stk./pcs. | 40 x 11 | 69488-5 | 22,72 |
| | | 60 x 11 | 69490-8 | 22,72 |
| | | 60 x 15 | 69492-2 | 23,96 |
| | | 100 x 11 | 69494-6 | 27,24 |
| nach RAL to RAL | 10 Stk./pcs. | 40 x 11 | 69508-0 | 26,68 |
| | | 60 x 11 | 69510-3 | 26,68 |
| | | 60 x 15 | 69512-7 | 27,92 |
| | | 100 x 11 | 69514-1 | 31,20 |
| Nur im Zusammenhang mit pulverbeschichteten Sockelleisten möglich! Only possible when ordering powder coated skirtings! | | | | |

470 Verbinder für CONTEGO-Sockelleiste, Aluminiumguss

connecting piece for
 CONTEGO skirting,
 aluminum casting



| | | | | |
|---|-----------------|----------|---------|-------|
| silberfarbig silver coloured | 10 Stk./pcs. | 40 x 11 | 69520-2 | 25,70 |
| | | 60 x 11 | 69522-6 | 26,12 |
| | | 60 x 15 | 69524-0 | 27,36 |
| | | 100 x 11 | 69526-4 | 29,66 |
| nach RAL to RAL | 10 Stk./pcs. | 40 x 11 | 69540-0 | 29,66 |
| | | 60 x 11 | 69542-4 | 30,08 |
| | | 60 x 15 | 69544-8 | 31,32 |
| | | 100 x 11 | 69546-2 | 33,64 |
| Nur im Zusammenhang mit pulverbeschichteten Sockelleisten möglich! Only possible when ordering powder coated skirtings! | | | | |

8. SOCKELLEISTEN/ 8. SKIRTINGS

**Lieferzeit für
 Pulverbeschichtung auf
 Anfrage / delivery time for powder
 coating on request**

| Zubehör für CONTEGO-Sockelleiste | | | | |
|---|---------|-------------------------------|-----------|-------------|
| accessories for CONTEGO skirting | | | | |
| Farbe/colour | VE/unit | für Größe/ for size AxB mm | Art./ref. | €/Stk./pcs. |

471 Endstück LINKS für CONTEGO-Sockelleiste, Aluminiumguss

left end cap for CONTEGO
 skirting, aluminum casting



| | | | | |
|---|-----------------|----------|---------|-------|
| silberfarbig silver coloured | 10 Stk./pcs. | 40 x 11 | 69552-3 | 23,26 |
| | | 60 x 11 | 69554-7 | 23,84 |
| | | 60 x 15 | 69556-1 | 25,10 |
| | | 100 x 11 | 69558-5 | 24,76 |
| nach RAL to RAL | 10 Stk./pcs. | 40 x 11 | 69572-1 | 27,24 |
| | | 60 x 11 | 69574-5 | 27,80 |
| | | 60 x 15 | 69576-9 | 29,04 |
| | | 100 x 11 | 69578-3 | 28,72 |
| Nur im Zusammenhang mit pulverbeschichteten Sockelleisten möglich! Only possible when ordering powder coated skirtings! | | | | |

472 Endstück RECHTS für CONTEGO-Sockelleiste, Aluminiumguss

right end cap for CONTEGO
 skirting, aluminum casting



| | | | | |
|---|-----------------|----------|---------|-------|
| silberfarbig silver coloured | 10 Stk./pcs. | 40 x 11 | 69924-8 | 23,26 |
| | | 60 x 11 | 69926-2 | 23,84 |
| | | 60 x 15 | 69928-6 | 25,10 |
| | | 100 x 11 | 69930-9 | 24,76 |
| nach RAL to RAL | 10 Stk./pcs. | 40 x 11 | 69944-6 | 27,24 |
| | | 60 x 11 | 69946-0 | 27,80 |
| | | 60 x 15 | 69948-4 | 29,04 |
| | | 100 x 11 | 69950-7 | 28,72 |
| Nur im Zusammenhang mit pulverbeschichteten Sockelleisten möglich! Only possible when ordering powder coated skirtings! | | | | |

Beispiel: Contego-Sockelleiste
 mit Zubehör (siehe Seite 122-124)
 example: Contego skirting with
 accessories (see page 122-124)



Beispiel: Alumium-Einklebe-
 Sockelleiste für 3 mm
 Designbeläge (siehe Seite 117)
 example: Design skirting for
 bonding floor to 3 mm, aluminium
 (see page 117)



8. SOCKELLEISTEN/ 8. SKIRTINGS

Klick-Sockelleiste aus Aluminium

| aluminium click skirtings | | | |
|---------------------------|-----------|-----------|-----|
| Farbe/colour | L / l (m) | Art./ref. | €/m |

301 Klick-Sockelleiste 60 x 15 mm, Aluminum elox., inklusive 6 Wandhalterungen mit

Schrauben & Dübel zur Befestigung

click skirting 60 x 15 mm, aluminum anodized, incl. 6 wall holders with screws and dowels for fastening



| | | | |
|---------------------------------|-----|---------|---------|
| silber elox. silver anodized | 2,5 | 61978-9 | 24,48/m |
|---------------------------------|-----|---------|---------|

| | | | |
|--|-----|---------|---------|
| edelstahlfarbig/ AL-INOX stainless steel coloured | 2,5 | 61980-2 | 26,74/m |
|--|-----|---------|---------|

andere Farben auf Anfrage/ other colours on demand

Zubehör für Klick-Sockelleiste 60 x 15 mm

| accessories for click skirtings 60 x 15 mm | | |
|--|-----------|---|
| Material+Farbe/ material+colour | Art./ref. | € |

302 Außencke für Klicksockelleiste 60 x 15 mm

outside corner for click skirting



| | | |
|--|---------|-----------------|
| Kunststoff silberfarbig plastic silver coloured | 61984-0 | 6,00 €/St./pcs. |
|--|---------|-----------------|

| | | |
|--|---------|-----------------|
| Kunststoff edelstahlfarbig plastic stainless steel coloured | 61992-5 | 6,60 €/St./pcs. |
|--|---------|-----------------|

303 Innenecke für Klicksockelleiste 60 x 15 mm

inside corner for click skirting



| | | |
|--|---------|-----------------|
| Kunststoff silberfarbig plastic silver coloured | 61986-4 | 6,00 €/St./pcs. |
|--|---------|-----------------|

| | | |
|--|---------|-----------------|
| Kunststoff edelstahlfarbig plastic stainless steel coloured | 61994-9 | 6,60 €/St./pcs. |
|--|---------|-----------------|

304 Verbinder für Klicksockelleiste 60 x 15 mm

connecting piece for click skirting



| | | |
|--|---------|-----------------|
| Kunststoff silberfarbig plastic silver coloured | 61988-8 | 5,20 €/St./pcs. |
|--|---------|-----------------|

| | | |
|--|---------|-----------------|
| Kunststoff edelstahlfarbig plastic stainless steel coloured | 61996-3 | 5,72 €/St./pcs. |
|--|---------|-----------------|

305 Endstücke, 1 Paar, für Klicksockelleiste 60 x 15 mm

end caps, 1 pair, for click skirting



| | | |
|--|---------|------------------|
| Kunststoff silberfarbig plastic silver coloured | 61990-1 | 9,60 €/Paar/pair |
|--|---------|------------------|

| | | |
|--|---------|-------------------|
| Kunststoff edelstahlfarbig plastic stainless steel coloured | 61998-7 | 10,58 €/Paar/pair |
|--|---------|-------------------|

9. FLIESENTRENN-, DEHNUNGSFUGEN-, BAU- & T-PROFILE AUS ALUMINIUM, EDELSTAHL, MESSING & PVC

9. CERAMIC TILE SEPARATION, EXPANSION GAP,
 BUILDING + T-PROFILES OUT OF ALUMINIUM,
 STAINLESS STEEL, BRASS + PVC

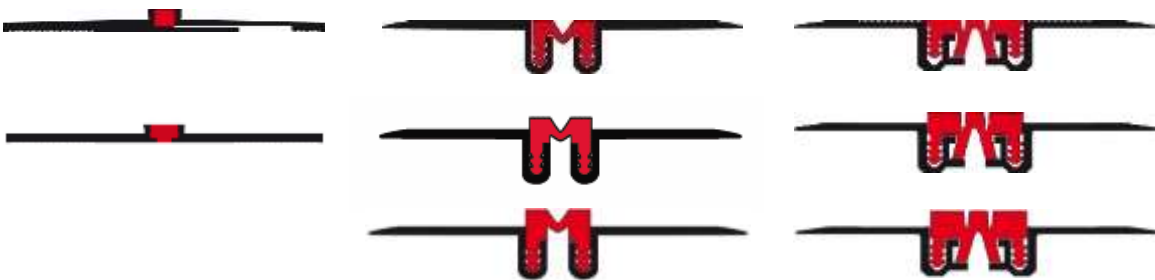

Fliesentrennprofil

ceramic tile separation profile

Fliesentrennprofil mit breitem Auflageschenkel

518

| Material/material | L / l (m) | Stk./VE / pcs/unit | Innenhöhe/inside height (mm) | Art./ref. | €/m | €/Stück/pcs. |
|--|-----------|--------------------|------------------------------|-----------|--------|--------------|
| Aluminium pressblank aluminium mill-finish | 2,7 m | 10 | 2,5 | 72250-2 | 5,20/m | 14,06 |
| | | | 3 | 71804-8 | 9,78/m | 26,40 |

ceramic tile separation profile with a wide contact surface



$h = \text{Innenhöhe} / \text{Außenmaß} = h + 1 \text{ mm}$

$h = \text{inside height} / \text{external dimension} = h + 1 \text{ mm}$

Dehnungsfugenprofile auf Anfrage produzierbar!

Expansion gap profiles can be produced on request!

Fliesentrennprofil

ceramic tile separation profile

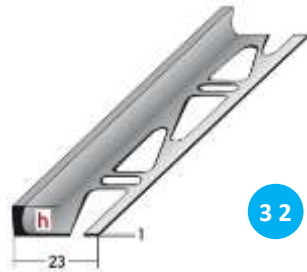

32

$h = \text{Innenmaß}$
 $\text{Außenmaß} = h + 1 \text{ mm}$
h = inside dimension
external dimension = h + 1 mm

| Material/material | L / l (m) | Stk./VE / pcs/unit | Innenhöhe/inside height (mm) | Art./ref. | €/m | €/Stück/pcs. |
|---|-----------|--------------------|------------------------------|-----------|--------|--------------|
| | | | | | | |
| Aluminium pressblank aluminium mill-finish | 1,0 m | 10 | 2 | 71808-6 | 3,62/m | 3,62 |
| | | | 2,5 | 71810-9 | 3,62/m | 3,62 |
| | | | 3 | 71812-3 | 3,62/m | 3,62 |
| | | | 4,5 | 71814-7 | 3,62/m | 3,62 |
| | | | 6 | 71816-1 | 3,66/m | 3,66 |
| | 2,5 m | 10 | 2 | 30129-5 | 3,62/m | 9,08 |
| | | | 2,5 | 30135-6 | 3,62/m | 9,08 |
| | | | 3 | 30130-1 | 3,62/m | 9,08 |
| | | | 4,5 | 30140-0 | 3,62/m | 9,08 |
| | | | 6 | 30150-9 | 3,66/m | 9,16 |
| 8 | | | 30160-8 | 4,08/m | 10,20 | |
| 10 | | | 30170-7 | 4,54/m | 11,32 | |
| 11 | | | 30175-2 | 4,82/m | 12,06 | |
| 12,5 | | | 30180-6 | 5,04/m | 12,58 | |
| 15 | | | 30190-5 | 5,66/m | 14,16 | |
| 18 | | | 30766-2 | 7,26/m | 18,14 | |
| 20 | | | 30767-9 | 9,08/m | 22,70 | |
| 22 | | | 30195-0 | 9,22/m | 23,02 | |
| 25 | | | 30768-6 | 9,76/m | 24,38 | |
| 30 | | | 30769-3 | 10,28/m | 25,72 | |
| Aluminium silber eloxiert aluminium silver anodized | 2,5 m | 10 | 2 | 69582-0 | 5,58/m | 13,96 |
| | | | 2,5 | 69584-4 | 5,58/m | 13,96 |
| | | | 3 | 69586-8 | 5,58/m | 13,96 |
| | | | 4,5 | 69588-2 | 5,58/m | 13,96 |
| | | | 6 | 69590-5 | 5,62/m | 14,08 |
| Aluminium schwarz elox. aluminium black anodized | 2,5 m | 10 | 2 | 69594-3 | 6,18/m | 15,48 |
| | | | 2,5 | 69596-7 | 6,18/m | 15,48 |
| | | | 3 | 69598-1 | 6,18/m | 15,48 |
| | | | 4,5 | 69600-1 | 6,18/m | 15,48 |
| | | | 6 | 69602-5 | 6,32/m | 15,80 |
| | | | 8 | 72480-3 | 6,48/m | 16,22 |
| | | | 10 | 72482-7 | 6,58/m | 16,46 |
| | | | 12,5 | 72484-1 | 6,90/m | 17,26 |
| 15 | 72486-5 | 7,04/m | 17,62 | | | |
| 22 | 72488-9 | 8,30/m | 20,78 | | | |

Andere Größen oder Eloxalfarben auf Anfrage möglich

other sizes or anodized colours available on request

32

32



9. FLIESENTRENN-, DEHNUNGSFUGEN-, BAU- & T-PROFILE/ 9. CERAMIC TILE SEPARATION, EXPANSION GAP, BUILDING + T-PROFILES

Fliesentrennprofil

ceramic tile separation profile

Fliesentrennprofil

ceramic tile
separation profile

34



h = Innenmaß
Außenmaß = h + 1 mm
 h = inside dimension
 external dimension = h + 1 mm

33

* Bestand muss geprüft
werden/ alternativ
Aluminium goldfarbig
eloxiert anfragen/
stock has to be checked /
alternatively ask for gold
coloured anodized aluminium

36

Innenmaß/ inside measure

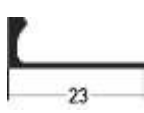
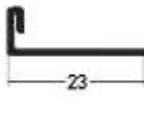
| Material/material | L / l (m) | Stk./VE / pcs/unit | Höhe/ height (mm) | Art./ref. | €/m | €/Stück/pcs. |
|--|-----------|-----------------------|----------------------|-----------|---------|--------------|
| Messing pressblank brass mill-finish  | 2,5 m | 10 | 3 | 30010-6 | 17,74/m | 44,40 |
| | | | 4,5 * | 30020-5 | 18,98/m | 47,46 |
| | | | 6 | 30030-4 | 19,92/m | 49,78 |
| | | | 8 | 30040-3 | 21,36/m | 53,40 |
| | | | 10 | 30050-2 | 23,54/m | 58,84 |
| | | | 12,5 | 30060-1 | 25,28/m | 63,22 |
| | | | 15 | 30070-0 | 26,40/m | 66,00 |
| | | | 22 | 30075-5 | 32,62/m | 81,54 |
| Edelstahl stainless steel  | 1,0 m | 10 | 2 | 71820-8 | 9,86/m | 9,86 |
| | | | 2,5 | 71822-2 | 9,86/m | 9,86 |
| | | | 3 | 71824-6 | 9,86/m | 9,86 |
| | | | 4,5 | 71826-0 | 10,14/m | 10,14 |
| | | | 6 | 71828-4 | 10,76/m | 10,76 |
| | 2,5 m | 10 | 2 | 30072-4 | 9,84/m | 24,60 |
| | | | 2,5 | 30765-5 | 9,84/m | 24,60 |
| | | | 3 | 30073-1 | 9,84/m | 24,60 |
| | | | 4,5 | 30074-8 | 10,14/m | 25,32 |
| | | | 6 | 30080-9 | 10,78/m | 26,96 |
| | | | 8 | 30090-8 | 11,12/m | 27,78 |
| | | | 10 | 30100-4 | 11,54/m | 28,82 |
| | | | 11 | 30105-9 | 12,08/m | 30,22 |
| | | | 12,5 | 30110-3 | 12,34/m | 30,84 |
| | | | 15 | 30120-2 | 12,74/m | 31,82 |
| | | | 17 | 30123-3 | 13,14/m | 32,82 |
| | | | 20 | 30762-4 | 13,52/m | 33,78 |
| | | | 22 | 30125-7 | 13,76/m | 34,40 |
| | | | 25 | 30763-1 | 15,06/m | 37,68 |
| | | | 30 | 30764-8 | 16,88/m | 42,24 |
| PVC weiß PVC white PVC beige PVC beige PVC grau PVC grey | 2,5 m | 10 | 6 | 30340-4 | 3,70/m | 9,24 |
| | | | 8 | 30350-3 | 4,10/m | 10,24 |
| | | | 10 | 30360-2 | 4,44/m | 11,10 |
| | | | 6 | 30370-1 | 3,70/m | 9,24 |
| | | | 8 | 30380-0 | 4,10/m | 10,24 |
| | | | 10 | 30390-9 | 4,44/m | 11,10 |
| | | | 6 | 30400-5 | 3,70/m | 9,24 |
| | | | 8 | 30410-4 | 4,10/m | 10,24 |
| | | | 10 | 30420-3 | 4,44/m | 11,10 |

FLIESENTRENN-, DEHNUNGSFUGEN-, BAU- & T-PROFILE/ 9. CERAMIC TILE SEPARATION, EXPANSION GAP, BUILDING + T-PROFILES

Flexibles Fliesentrennprofil

flexible ceramic tile separation profile

Flexibles Fliesentrennprofil

flexible ceramic tile separation profile



h = Innenmaß



Außenmaß = h + 1 mm

h = inside dimension

external dimension = h + 1 mm

*** Bestand muss geprüft werden/ alternativ Aluminium goldfarbig eloxiert anfragen/**

stock has to be checked / alternatively ask for gold coloured anodized aluminium

| Innenmaß/ inside measure | | | | | | |
|---|-----------|--------------------|-------------------|-----------|---------|---------------|
| Material/material | L / l (m) | Stk./VE / pcs/unit | Höhe/ height (mm) | Art./ref. | €/m | €/Stück/ pcs. |
| Aluminium pressblank aluminium mill-finish  | 2,5 m | 10 | 2 | 30268-1 | 6,72/m | 16,78 |
| | | | 3 | 30270-4 | 6,02/m | 15,06 |
| | | | 4,5 | 30280-3 | 6,10/m | 15,26 |
| | | | 6 | 30290-2 | 6,22/m | 15,54 |
| | | | 8 | 30300-8 | 6,42/m | 16,02 |
| | | | 10 | 30310-7 | 6,72/m | 16,80 |
| | | | 12,5 | 30320-6 | 7,12/m | 17,80 |
| | | | 15 | 30330-5 | 7,62/m | 19,04 |
| | | | 18 | 69606-3 | 9,36/m | 23,40 |
| | | | 20 | 69608-7 | 9,82/m | 24,52 |
| | | | 22 | 30335-0 | 10,10/m | 25,22 |
| | | | 25 | 69612-4 | 11,64/m | 29,10 |
| 30 | 69614-8 | 12,76/m | 31,88 | | | |
| Messing pressblank brass mill-finish  | 2,5 m | 10 | 3 | 30200-1 | 19,70/m | 49,24 |
| | | | 4,5 * | 30210-0 | 20,80/m | 51,96 |
| | | | 6 | 30220-9 | 22,12/m | 55,30 |
| | | | 8 | 30230-8 | 24,14/m | 60,36 |
| | | | 10 | 30240-7 | 25,92/m | 64,78 |
| | | | 12,5 | 30250-6 | 27,36/m | 68,40 |
| | | | 15 | 30260-5 | 29,50/m | 73,72 |
| Edelstahl stainless steel  | 2,5 m | 10 | 3 | 38000-9 | 18,28/m | 45,70 |
| | | | 4,5 | 38010-8 | 18,42/m | 46,06 |
| | | | 6 | 38020-7 | 20,56/m | 51,42 |
| | | | 8 | 38030-6 | 21,24/m | 53,06 |
| | | | 10 | 38040-5 | 22,08/m | 55,18 |
| | | | 12,5 | 38050-4 | 22,76/m | 56,90 |
| 15 | 38060-3 | 27,34/m | 68,34 | | | |

Bieegerät für flexible Fliesentrennprofile

bending machine for flexible ceramic tile and separation profiles



| Art./ref. | €/Stück/pcs. |
|-----------|--------------|
| 31050-1 | 791,76 |

MIET-Bieegerät für flexible Fliesentrennprofile für 14-tägige Nutzung

rental bending machine for flexible ceramic tile separation profiles for 14 days of use



| Art./ref. | €/Stück/pcs. |
|-----------|--------------|
| 71832-1 | 108,58 |

Verfügbarkeit auf Anfrage / availability on request

Mietzeit beginnt am Paketzustellungstag / rental period begins on the day of delivery of the package

Rückversand durch Kunde / return shipment by customer

Dehnungsfugenprofile Aluminium, VE 10 Stück

expansion gap profiles aluminium, sales unit 10 pcs.

3 1



h = Innenmaß
Außenmaß = h + 1 mm
h = inside dimension
external dimension = h + 1 mm

Dehnungsfugenprofile aus Profilnr. 518 mit breitem Auflageschenkel auf Anfrage produzierbar!
Expansion gap profiles from profile no. 518 with a wide support leg can be produced on request!

| Material/ Farbe material/ colour | Silikonfarbe / silicone colour | Länge / length (m) | Innenhöhe/ inside height (mm) | Art./ref. | €/m | €/Stück/ pcs. | | |
|---|---------------------------------------|--|-------------------------------|-----------|---------|---------------|---------|-------|
| Aluminium pressblank aluminium mill-finish | Silikon grau | 1,0 m | 2 | 71836-9 | 18,20/m | 18,20 | | |
| | | | 2,5 | 71838-3 | 18,24/m | 18,24 | | |
| | | | 3 | 71840-6 | 18,30/m | 18,30 | | |
| | | | 4,5 | 71842-0 | 18,76/m | 18,76 | | |
| | | | 6 | 71844-4 | 18,86/m | 18,86 | | |
| | | 2,5 m | 2 | 37630-9 | 18,20/m | 45,52 | | |
| | | | 2,5 | 37105-2 | 18,24/m | 45,62 | | |
| | | | 3 | 37100-7 | 18,30/m | 45,78 | | |
| | | | 4,5 | 37600-2 | 18,76/m | 46,82 | | |
| | | | 6 | 36230-2 | 18,86/m | 47,16 | | |
| | | | 8 | 36240-1 | 20,14/m | 50,38 | | |
| | | | 10 | 36250-0 | 26,98/m | 67,48 | | |
| | | | 11 | 36255-5 | 31,14/m | 77,86 | | |
| | | | 12,5 | 37632-3 | 35,44/m | 88,60 | | |
| | | 15 | 37634-7 | 37,88/m | 94,70 | | | |
| | | 25 | 37636-1 | 49,48/m | 123,68 | | | |
| | | 3,0 m * | 2 | 72492-6 | 18,20/m | 54,62 | | |
| | | | 2,5 | 72494-0 | 18,24/m | 54,72 | | |
| | | | 3 | 72496-4 | 18,30/m | 54,92 | | |
| | | | 4,5 | 72498-8 | 18,76/m | 56,26 | | |
| | | | 6 | 72500-8 | 18,86/m | 56,56 | | |
| | | * 3,0 m-Ware ist nur per Spedition lieferbar (gesonderte Transportkosten) / 3,0 m profiles are only available per forwarding agency (separate transport costs) | | | | | | |
| | | Aluminium schwarz eloxiert aluminium black anodized | Silikon schwarz | 2,5 m | 2 | 72504-6 | 22,46/m | 56,18 |
| | | | | | 2,5 | 72506-0 | 22,52/m | 56,28 |
| | | | | | 3 | 72508-4 | 22,60/m | 56,50 |
| 4,5 | 72510-7 | | | | 23,14/m | 57,78 | | |
| 6 | 72512-1 | | | | 23,28/m | 58,20 | | |
| Aluminium silber eloxiert aluminium silver anodized | Silikon grau | 2,5 m | 2 | 69620-9 | 21,34/m | 53,32 | | |
| | | | 2,5 | 69622-3 | 21,36/m | 53,42 | | |
| | | | 3 | 69624-7 | 21,46/m | 53,64 | | |
| | | | 4,5 | 69626-1 | 21,86/m | 54,68 | | |
| | | | 6 | 69628-5 | 22,06/m | 55,18 | | |
| Aluminium schwarz eloxiert aluminium black anodized | Silikon schwarz | 2,5 m | 2 | 69634-6 | 27,56/m | 68,90 | | |
| | | | 2,5 | 69636-0 | 27,60/m | 69,04 | | |
| | | | 3 | 69638-4 | 27,72/m | 69,28 | | |
| | | | 4,5 | 69640-7 | 28,24/m | 70,58 | | |
| | | | 6 | 69642-1 | 28,62/m | 71,56 | | |
| | Silikon silber Diamant-Glitter | 2,5 m | 2 | 69648-3 | 37,22/m | 93,04 | | |
| | | | 2,5 | 69650-6 | 37,26/m | 93,16 | | |
| | | | 3 | 69652-0 | 37,40/m | 93,52 | | |
| | | | 4,5 | 69654-4 | 38,12/m | 95,30 | | |
| | | | 6 | 69656-8 | 38,64/m | 96,62 | | |

Farbige Silikoneinlagen nach Farbauswahl von Otto Chemie, sowie RAL und NCS:

choice of colours by Otto Chemie, RAL colours and NCS:

bis 25 m je Farbe/ up to 25m of a colour --> 30 % Preisauflschlag/ 30 % additional charge

ab 25 m je Farbe/ from 25m of a colour --> 15 % Preisauflschlag/ 15 % additional charge

ab 100 m je Farbe/ from 100m of a colour --> kein Preisauflschlag/ no additional charge

Lieferzeit auf Anfrage/ delivery time on request



9. FLIESENTRENN-, DEHNUNGSFUGEN-, BAU- & T-PROFILE/ 9. CERAMIC TILE SEPARATION, EXPANSION GAP, BUILDING + T-PROFILES

Dehnungsfugenprofile, VE 10 Stück

expansion gap profiles, sales unit 10 pcs.

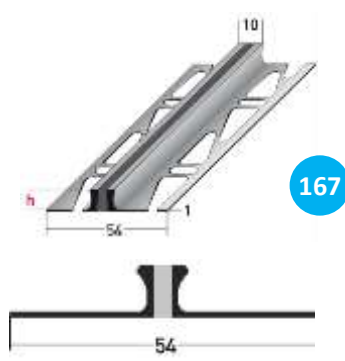
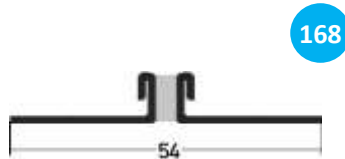
| Material/ Farbe material/ colour | Silikonfarbe / silicone colour | Länge / length (m) | Innenhöhe/ inside height (mm) | Art./ref. | €/m | €/Stück/ pcs. |
|---|-----------------------------------|--------------------------|-------------------------------------|-----------|----------|------------------|
|  <p>167 Messing pressblank brass mill-finish</p> | Silikon grau | 2,5 m | 3 | 37110-6 | 55,56/m | 138,88 |
| | | | 4,5 * | 37610-1 | 58,40/m | 146,00 |
| | | | 6 | 36290-6 | 61,10/m | 152,72 |
| | | | 8 | 36300-2 | 66,14/m | 165,36 |
| | | | 10 | 36310-1 | 72,24/m | 180,58 |
| | | | 12,5 | 37642-2 | 83,74/m | 209,34 |
| | | | 15 | 37644-6 | 89,18/m | 222,98 |
| | | | 25 | 37646-0 | 109,46/m | 273,64 |
| <p>* Bestand muss geprüft werden/ alternativ Aluminium goldfarbig eloxiert anfragen/ stock has to be checked / alternatively ask for gold coloured anodized aluminium</p>  <p>168 Edelstahl stainless steel</p> | Silikon grau | 1,0 m | 2 | 71848-2 | 29,68/m | 29,68 |
| | | | 2,5 | 71850-5 | 29,68/m | 29,68 |
| | | | 3 | 71852-9 | 29,68/m | 29,68 |
| | | | 4,5 | 71854-3 | 34,52/m | 34,52 |
| | | | 6 | 71856-7 | 36,76/m | 36,76 |
| | | 2,5 m | 2 | 37650-7 | 29,68/m | 74,18 |
| | | | 2,5 | 37651-4 | 29,68/m | 74,18 |
| | | | 3 | 37115-1 | 29,68/m | 74,18 |
| | | | 4,5 | 37620-0 | 34,52/m | 86,30 |
| | | | 6 | 36350-7 | 36,76/m | 91,90 |
| | | | 8 | 36360-6 | 42,34/m | 105,80 |
| | | | 10 | 36370-5 | 57,32/m | 143,28 |
| | | | 11 | 36375-0 | 61,94/m | 154,86 |
| | | | 12,5 | 37652-1 | 66,60/m | 166,48 |
| 15 | 37654-5 | 76,40/m | 191,02 | | | |
| 25 | 37656-9 | 94,18/m | 235,46 | | | |

h = Innenmaß
Außenmaß = h + 1 mm
h = inside dimension
external dimension = h + 1 mm

Farbige Silikoneinlagen nach Farbauswahl von Otto Chemie, sowie RAL- und NCS:

choice of colours by Otto Chemie, RAL colours and NCS:

bis 25 m je Farbe/ up to 25m of a colour --> 30 % Preisauflschlag/ 30 % additional charge

ab 25 m je Farbe/ from 25m of a colour --> 15 % Preisauflschlag/ 15 % additional charge

ab 100 m je Farbe/ from 100m of a colour --> kein Preisauflschlag/ no additional charge

Lieferzeit auf Anfrage/ delivery time on request

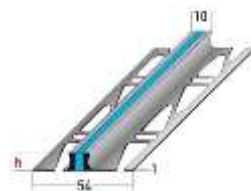

169 PVC-Dehnungsfugenprofil

PVC-expansion
gap profile



| Farbe / colour | Länge / length (m) | Innenhöhe/ inside height (mm) | Art./ref. | €/m | €/Stück/ pcs. |
|------------------------|--------------------------|-------------------------------------|-----------|---------|------------------|
| PVC weiß PVC white | 2,5 m | 6 | 36440-5 | 10,24/m | 25,60 |
| PVC beige PVC beige | | | 36500-6 | 10,24/m | 25,60 |
| PVC grau PVC grey | | | 36560-0 | 10,24/m | 25,60 |

281 Wellenverbinder 70 x 6 mm zur Beseitigung von Estrichrissen

wave connector 70 x 6 mm for fixing
concrete
floor crack

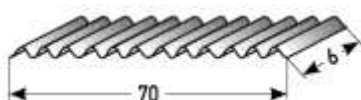

| Stk./Verpack. pcs./pack | Stk./VE / pcs./unit | Art./ref. | € |
|---------------------------------------|------------------------|-----------|-----------------|
| Karton à 1000 Stk. box a 1000 pcs. | 1 | 36620-1 | 77,90/Kart./box |
| Beutel à 100 St. bag a 100 pcs. | 10 | 36621-8 | 10,44/Btl./bag |

**Ihre Wunschzusammenstellung war noch nicht dabei?
 Kein Problem - individuell auf Anfrage erhältlich!**

Andere Profilfarben, farbige Silikoneinlagen, andere Füllungen, verlegefertige T- oder X-Dehnungsfugenkreuze, u.v.m. fertigen wir gern für Sie individuell nach Ihren Wünschen!

Your desired compilation was not included? No problem - individually available on request! We would be happy to manufacture other leg colours, coloured silicone inserts, other fillings, ready-to-lay T or X expansion spacers and much more according to your wishes!



Bild 1: Glittervarianten mit schwarzer Silikonbasis
 Image 1: Glitter variants with a black silicone base



Bild 2: Dehnungsfugenprofil h=2,5 mm mit breiten Auflageschenkeln mit schwarzer Silikoninlage
 Image 2: Expansion joint profile h=2,5 mm with wide support legs with black silicone insert



Bild 3 : T-Dehnungsfugenkreuz
 Image 3: T-expansion joint cross



Bild 4 : X-Dehnungsfugenkreuz
 Image 4 : x-expansion joint cross

9. FLIESENTRENN-, DEHNUNGSFUGEN-, BAU- & T-PROFILE/ 9. CERAMIC TILE SEPARATION, EXPANSION GAP, BUILDING + T-PROFILES

Spezial-Dehnungsfugenprofil

special expansion gap profile

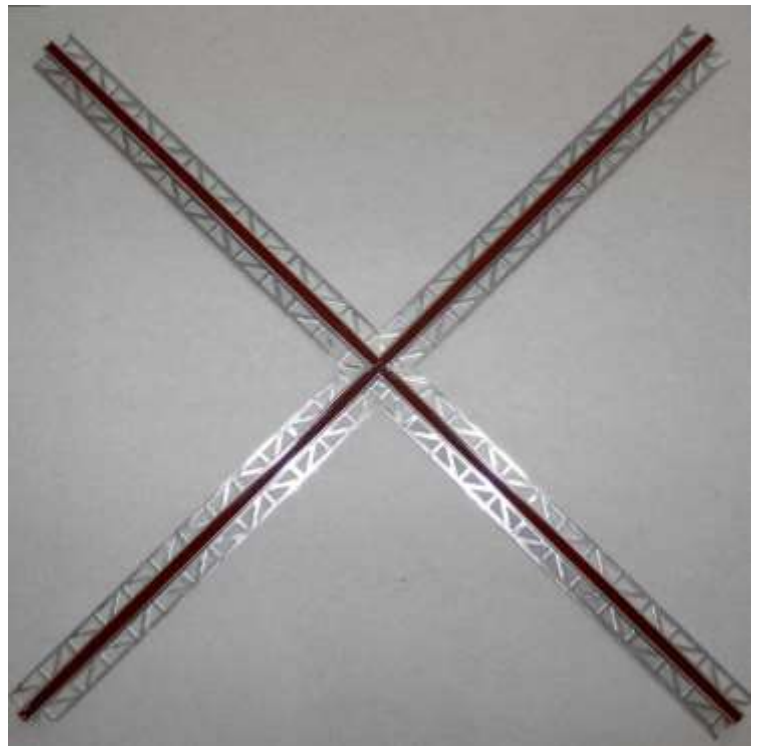
Innenmaß/ inside measure

| Material/ material | L / l (m) | Stk./VE / pcs/unit | Höhe/ height h (mm) | Art./ref. | €/m | €/Stück/ pcs. |
|-----------------------|-----------|-----------------------|------------------------|-----------|-----|------------------|
|-----------------------|-----------|-----------------------|------------------------|-----------|-----|------------------|

322 Spezial-Dehnungsfugenprofil, Fugenbreite bis 20 mm, gebohrt

expansion gap profile,
joint width up to 20 mm,
drilled

für starke Belastungen
for heavy loads

| | | | | | | |
|---|-------|----|-----|---------|---------|-------|
| Aluminium pressblank aluminium mill-finish | 2,5 m | 10 | 2,2 | 37728-3 | 35,06/m | 87,64 |
| | | | 2,8 | 37730-6 | 36,10/m | 90,26 |
| | | | 3,7 | 37768-9 | 37,38/m | 93,48 |
| | | | 5 | 37770-2 | 39,08/m | 97,72 |

**Füllbereich 10 mm,
gefüllt mit grauem Silikon**
filling area 10 mm,
filled with grey silicone

**andere Fugenbreiten auf
Anfrage gegen Aufpreis (15%)
möglich/** other joint widths on
request for an additional charge (15%)
possible

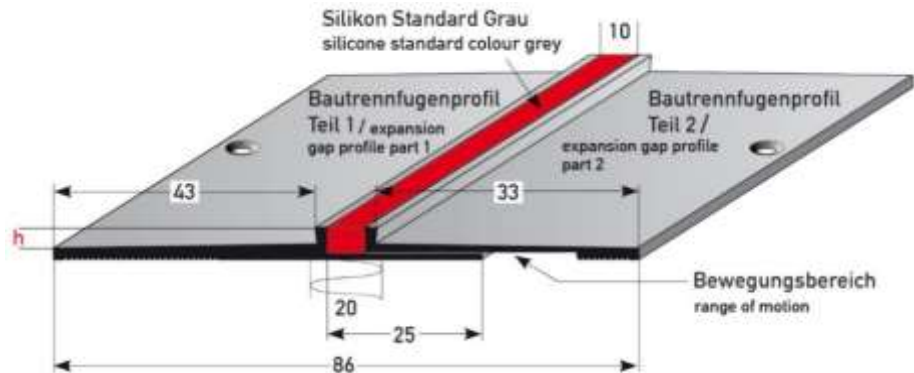

479 Spezial-Dehnungsfugenpr., 3-dimensional beweglich, Fugenbreite bis 20 mm, gebohrt

expansion gap profile,
joint width up to 20 mm,
drilled, 3-dimensionally
movable

für starke Belastungen
for heavy loads

| | | | | | | |
|---|-----|----|-----|---------|---------|-------|
| Aluminium pressblank aluminium mill-finish | 2,5 | 10 | 2,2 | 70896-4 | 35,06/m | 87,64 |
| | | | 2,8 | 70898-8 | 36,10/m | 90,26 |

**Füllbereich 10 mm,
gefüllt mit grauem Silikon**
filling area 10 mm,
filled with grey silicone

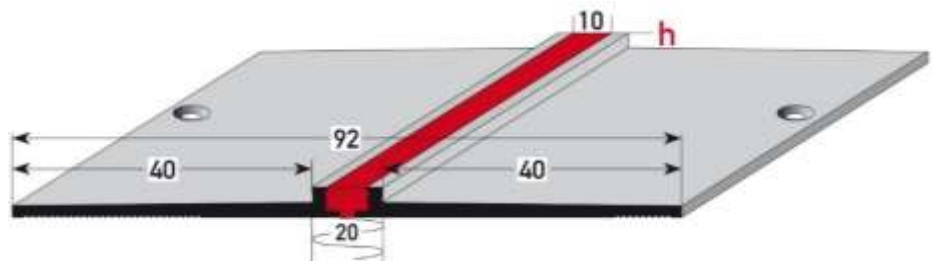

Farbige Silikoneinlagen nach Farbauswahl von Otto Chemie, sowie RAL und NCS:

choice of colours by Otto Chemie, RAL colours and NCS:

bis 25 m je Farbe/ up to 25m of a colour --> **30 %** Preisauflschlag/ 30 % additional charge

ab 25 m je Farbe/ from 25m of a colour --> **15 %** Preisauflschlag/ 15 % additional charge

ab 100 m je Farbe/ from 100m of a colour --> **kein** Preisauflschlag/ no additional charge

Lieferzeit auf Anfrage/ delivery time on request

Dehnungsfugenprofile "SUPER 20" für nachträglichen Einbau

expansion gap profile "SUPER 20" - for subsequent installation

| Material/ material | L / l (m) | Stk./VE / pcs/unit | Belaghöhe/ flooring height (mm) | Art./ref. | €/m | €/Stück/ pcs. |
|-----------------------|-----------|-----------------------|---------------------------------------|-----------|-----|------------------|
|-----------------------|-----------|-----------------------|---------------------------------------|-----------|-----|------------------|

323 Dehnungsfugenprofil TYP 20/12, für über 20 mm Fugenbreite, gebohrt,
 mit grauer PVC-Einlage, für nachträglichen Einbau, zum Aufsetzen auf den Bodenbelag

expansion gap profile type 20/12, for over 20 mm joint width, drilled, with grey PVC insert, for subsequent installation, to be placed on the flooring

| | | | | | | |
|---|-------|----|---|---------|---------|--------|
| Aluminium pressblank aluminium mill-finish | 2,0 m | 10 | - | 37734-4 | 76,04/m | 152,06 |
| | 4,0 m | | | 37736-8 | | 304,16 |

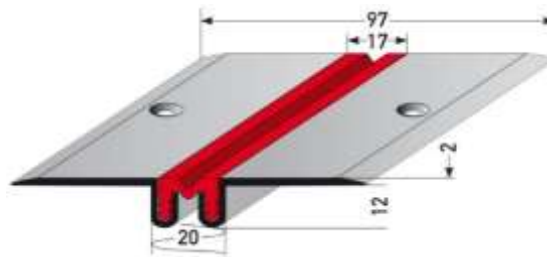

324 Dehnungsfugenprofil TYP 20/12/3, für über 20 mm Fugenbreite, gebohrt,
 mit grauer PVC-Einlage, für nachträglichen Einbau, zum Anstoßen von 3 mm Belag

expansion gap profile type 20/12/3, for over 20 mm joint width, drilled, with grey PVC insert, for subsequent installation, for abutting 3 mm flooring

| | | | | | | |
|---|-------|----|------|---------|---------|--------|
| Aluminium pressblank aluminium mill-finish | 2,0 m | 10 | 3 mm | 37740-5 | 77,34/m | 154,64 |
| | 4,0 m | | | 37742-9 | | 309,26 |

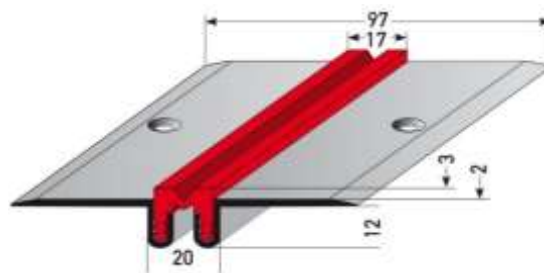

482 Dehnungsfugenprofil TYP 20/12/5, für über 20 mm Fugenbreite, gebohrt,
 mit grauer PVC-Einlage, für nachträglichen Einbau, zum Anstoßen von 5 mm Belag

expansion gap profile type 20/12/5, for over 20 mm joint width, drilled, with grey PVC insert, for subsequent installation, for abutting 5 mm flooring

| | | | | | | |
|---|-------|----|------|---------|---------|--------|
| Aluminium pressblank aluminium mill-finish | 2,0 m | 10 | 5 mm | 70976-3 | 77,34/m | 154,64 |
| | 4,0 m | | | 70978-7 | | 309,26 |

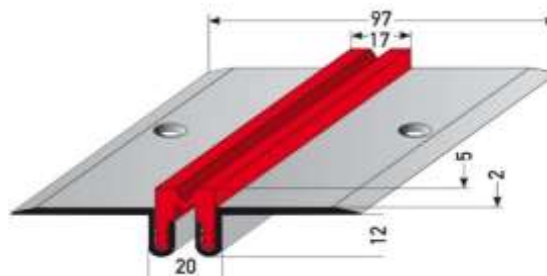

4,0 m-Ware ist nur per Spedition lieferbar (gesonderte Transportkosten)
 4,0 m profiles are only available per forwarding agency (separate transport costs)

Dehnungsfugenprofile "SUPER 35" für nachträglichen Einbau

expansion gap profile "SUPER 35" - for subsequent installation

| Material/ material | L / l (m) | Stk./VE / pcs/unit | Belaghöhe/ flooring height (mm) | Art./ref. | €/m | €/Stück/ pcs. |
|-----------------------|-----------|-----------------------|---------------------------------------|-----------|-----|------------------|
|-----------------------|-----------|-----------------------|---------------------------------------|-----------|-----|------------------|

325 Dehnungsfugenprofil TYP 35/15, für über 35 mm Fugenbreite, gebohrt,
mit grauer PVC-Einlage, für nachträglichen Einbau, zum Aufsetzen auf den Bodenbelag

expansion gap profile type 35/15, for over 35 mm joint width, drilled, with grey PVC insert, for subsequent installation, to be placed on the flooring

| | | | | | | |
|---|-------|----|---|---------|----------|--------|
| Aluminium pressblank aluminium mill-finish | 2,0 m | 10 | - | 37746-7 | 103,80/m | 207,64 |
| | 4,0 m | | | 37748-1 | | 415,22 |

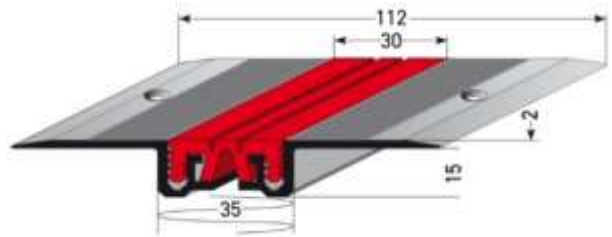

326 Dehnungsfugenprofil TYP 35/15/3, für über 35 mm Fugenbreite, gebohrt,
mit grauer PVC-Einlage, für nachträglichen Einbau, zum Anstoßen von 3 mm Belag

expansion gap profile type 35/15/3, for over 35 mm joint width, drilled, with grey PVC insert, for subsequent installation, for abutting 3 mm flooring

| | | | | | | |
|---|-------|----|------|---------|----------|--------|
| Aluminium pressblank aluminium mill-finish | 2,0 m | 10 | 3 mm | 37752-8 | 105,52/m | 211,04 |
| | 4,0 m | | | 37754-2 | | 422,06 |

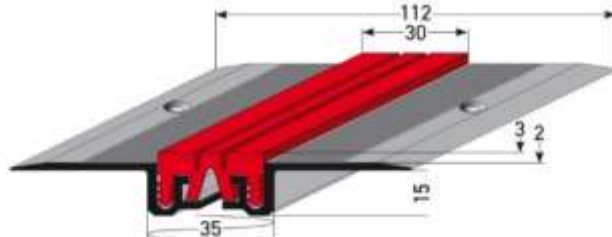

484 Dehnungsfugenprofil TYP 35/15/5, für über 35 mm Fugenbreite, gebohrt,
mit grauer PVC-Einlage, für nachträglichen Einbau, zum Anstoßen von 5 mm Belag

expansion gap profile type 35/15/5, for over 35 mm joint width, drilled, with grey PVC insert, for subsequent installation, for abutting 5 mm flooring

| | | | | | | |
|---|-------|----|------|---------|----------|--------|
| Aluminium pressblank aluminium mill-finish | 2,0 m | 10 | 5 mm | 70982-4 | 105,52/m | 211,04 |
| | 4,0 m | | | 70984-8 | | 422,06 |

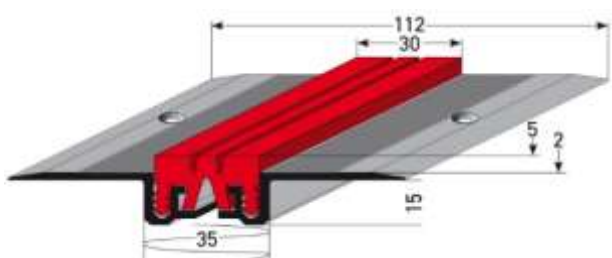

4,0 m-Ware ist nur per Spedition lieferbar (gesonderte Transportkosten)
4,0 m profiles are only available per forwarding agency (separate transport costs)

9. FLIESENTRENN-, DEHNUNGSFUGEN-, BAU- & T-PROFILE/ 9. CERAMIC TILE SEPARATION, EXPANSION GAP, BUILDING + T-PROFILES

andere Längen+Abmessungen auf Anfrage/
 other lengths and dimensions on demand

Lagerlängen à 6 m
 in stock lengths à 6 m

170 Winkelprofil

angle edge

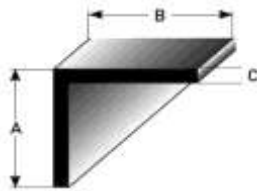

| Aluminium-Bauprofile pressblank (Außenmaße) | | | | |
|--|-----------|-------------|-----------|--------------|
| aluminium building profiles mill-finish (outside measures) | | | | |
| L / l (m) | VE / unit | AxBxC mm | Art./ref. | €/Stück/pcs. |
| 1,0 | 10 | 10 x 10 x 2 | 37120-5 | 5,48 |
| | | 15 x 15 x 2 | 37122-9 | 5,96 |
| | | 20 x 20 x 2 | 37130-4 | 6,40 |
| | | 25 x 25 x 2 | 37132-8 | 7,90 |
| | | 30 x 30 x 2 | 37140-3 | 9,42 |
| 2,0 | 10 | 10 x 10 x 2 | 37150-2 | 10,96 |
| | | 15 x 15 x 2 | 37152-6 | 11,90 |
| | | 20 x 20 x 2 | 37160-1 | 12,66 |
| | | 25 x 25 x 2 | 37162-5 | 15,80 |
| | | 30 x 30 x 2 | 37170-0 | 18,72 |

171 U-Profil

U-profile

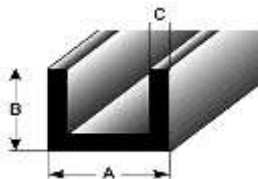

| | | | | |
|-----|----|-------------|---------|-------|
| 1,0 | 10 | 10 x 10 x 2 | 37180-9 | 8,24 |
| | | 15 x 15 x 2 | 37182-3 | 8,62 |
| | | 20 x 20 x 2 | 37190-8 | 9,02 |
| | | 30 x 30 x 3 | 37200-4 | 20,58 |
| 2,0 | 10 | 10 x 10 x 2 | 37210-3 | 16,46 |
| | | 15 x 15 x 2 | 37212-7 | 17,24 |
| | | 20 x 20 x 2 | 37220-2 | 18,12 |
| | | 30 x 30 x 3 | 37230-1 | 41,04 |

172 T-Profil

T-profile

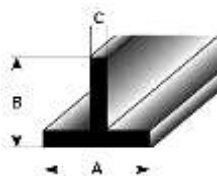

| | | | | |
|-----|----|-------------|---------|-------|
| 1,0 | 10 | 20 x 20 x 2 | 37240-0 | 10,08 |
| | | 25 x 25 x 3 | 37250-9 | 11,48 |
| | | 30 x 30 x 3 | 37260-8 | 14,18 |
| 2,0 | 10 | 20 x 20 x 2 | 37270-7 | 20,16 |
| | | 25 x 25 x 3 | 37280-6 | 22,92 |
| | | 30 x 30 x 3 | 37290-5 | 28,32 |

173 Rohr

pipe

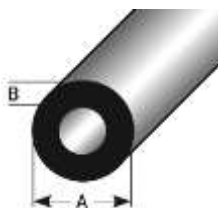

| | | | | |
|-----|----|--------|---------|-------|
| 1,0 | 10 | 10 x 1 | 37300-1 | 5,20 |
| | | 12 x 1 | 37310-0 | 6,16 |
| | | 16 x 2 | 37320-9 | 7,22 |
| 2,0 | 10 | 10 x 1 | 37330-8 | 10,50 |
| | | 12 x 1 | 37340-7 | 12,34 |
| | | 16 x 2 | 37350-6 | 14,54 |

174 Flachprofil

flat profile



| | | | | |
|-----|----|--------|---------|-------|
| 1,0 | 10 | 10 x 2 | 37360-5 | 2,74 |
| | | 15 x 2 | 37362-9 | 4,14 |
| | | 20 x 2 | 37364-3 | 5,50 |
| | | 30 x 2 | 37370-4 | 6,56 |
| | | 40 x 3 | 37380-3 | 9,66 |
| 2,0 | 10 | 10 x 2 | 37390-2 | 5,48 |
| | | 15 x 2 | 37392-6 | 8,26 |
| | | 20 x 2 | 37394-0 | 11,02 |
| | | 30 x 2 | 37400-8 | 13,18 |
| | | 40 x 3 | 37410-7 | 19,28 |

175 Vierkantrrohr

rectangular pipe

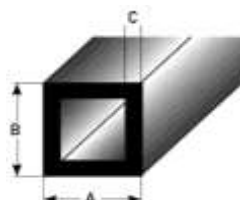

| | | | | |
|-----|----|---------------|---------|-------|
| 1,0 | 10 | 15 x 15 x 1,5 | 37420-6 | 12,10 |
| | | 20 x 20 x 2 | 37430-5 | 16,04 |
| | | 30 x 30 x 3 | 37440-4 | 27,34 |
| 2,0 | 10 | 15 x 15 x 1,5 | 37450-3 | 24,10 |
| | | 20 x 20 x 2 | 37460-2 | 32,14 |
| | | 30 x 30 x 3 | 37470-1 | 54,70 |

9. FLIESENTRENN-, DEHNUNGSFUGEN-, BAU- & T-PROFILE/ 9. CERAMIC TILE SEPARATION, EXPANSION GAP, BUILDING + T-PROFILES

* kann 40 mm Klemmstelle vom Eloxieren enthalten/
 may contain 40 mm clamping point from anodizing

178 Winkelprofil gleichschenkelig

Aluminium silber eloxiert
 angle edge, equal size sides,
 aluminium silver anodized

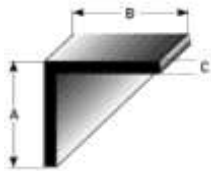

| Aluminium-Bauprofile silber eloxiert (Außenmaße) | | | | |
|--|-----------|---------------|-----------|---------------|
| aluminium building profiles silver anodized (outside measures) | | | | |
| L / l (m) | VE / unit | AxBxC mm | Art./ref. | €/Stück/ pcs. |
| 1,0 m* | 10 | 10 x 10 x 1 | 45000-9 | 3,94 |
| | | 15 x 15 x 1 | 45002-3 | 5,44 |
| | | 20 x 20 x 1,5 | 45004-7 | 7,48 |
| | | 25 x 25 x 1,5 | 45006-1 | 9,24 |
| | | 30 x 30 x 1,5 | 45008-5 | 11,18 |
| | | 40 x 40 x 1,5 | 45010-8 | 14,98 |
| 2,0 m* | 10 | 10 x 10 x 1 | 45016-0 | 7,90 |
| | | 15 x 15 x 1 | 45018-4 | 10,90 |
| | | 20 x 20 x 1,5 | 45020-7 | 14,98 |
| | | 25 x 25 x 1,5 | 45022-1 | 18,48 |
| | | 30 x 30 x 1,5 | 45024-5 | 22,38 |
| | | 40 x 40 x 1,5 | 45026-9 | 29,90 |

179 Winkelprofil ungleichschenkelig

Aluminium silber eloxiert
 angle edge, different size sides
 aluminium silver anodized



| | | | | |
|--------|----|---------------|---------|-------|
| 1,0 m* | 10 | 15 x 10 x 1 | 45032-0 | 4,58 |
| | | 20 x 15 x 1,5 | 45034-4 | 6,54 |
| | | 25 x 15 x 1,5 | 45036-8 | 7,38 |
| | | 30 x 20 x 1,5 | 45038-2 | 9,38 |
| | | 40 x 20 x 1,5 | 45040-5 | 11,18 |
| 2,0 m* | 10 | 15 x 10 x 1 | 45046-7 | 9,12 |
| | | 20 x 15 x 1,5 | 45048-1 | 13,10 |
| | | 25 x 15 x 1,5 | 45050-4 | 14,72 |
| | | 30 x 20 x 1,5 | 45052-8 | 18,68 |
| | | 40 x 20 x 1,5 | 45054-2 | 22,38 |

andere Längen + Abmessungen auf Anfrage/ other lengths and dimensions on demand

Lagerlängen à 6 m
 in stock lengths à 6 m

FLIESENTRENN-, DEHNUNGSFUGEN-, BAU- & T-PROFILE/ 9. CERAMIC TILE SEPARATION, EXPANSION GAP, BUILDING + T-PROFILES

** inklusive 40 mm Klemm-
stelle an einer Seite vom
Eloxieren/ including 40 mm
clamping point on one side
from anodizing

**2 5 T-Profil 14 mm
für Übergänge**

T-profile 14 mm for transition

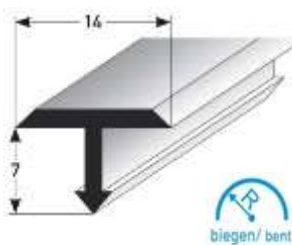

| Fußboden - T - Profile | | | | | |
|--|--------------|--------------|-----------|-------|---------------|
| T - profiles | | | | | |
| Material+Farbe/ material+colour | Höhe/ height | L / l (m) | Art./ref. | €/m | €/Stück/ pcs. |
| Messing ziehblank brass mill-finish | 7 mm | 2,5 m | 36380-4 | 15,60 | 39,00 |
| Aluminium blank alu mill-finish | | | 36390-3 | 3,94 | 9,82 |
| Alu silber alu silver | | | 46630-7 | 6,06 | 15,14 |
| Alu gold alu gold | | | 46632-1 | 6,98 | 17,42 |
| Alu bronze hell alu bonze light | | 2,5 m** | 46634-5 | 8,46 | 21,10 |
| Alu bronze dunkel alu bonze dark | | | 46636-9 | 8,46 | 21,10 |
| Edelstahl matt stainless steel matt | 7 mm | NEU! 1,0 m | 72362-2 | 15,62 | 15,62 |
| | | 2,5 m | 36420-7 | 15,62 | 39,06 |
| | | NEU! 3,0 m * | 72364-6 | 15,62 | 46,86 |
| * 3,0 m-Ware ist nur per Spedition lieferbar (gesonderte Transportkosten) 3,0 m profiles are only available per forwarding agency (separate transport costs) | | | | | |

**2 6 T-Profil 25 mm
für Übergänge**

T-profile 25 mm for transition



| | | | | | |
|--|------|--------------|---------|-------|--------|
| Messing ziehblank brass mill-finish | 7 mm | 2,5 m | 36400-9 | 43,62 | 109,04 |
| Aluminium blank alu mill-finish | | | 36410-8 | 8,42 | 21,00 |
| Alu silber alu silver | | | 46640-6 | 10,74 | 26,86 |
| Alu gold alu gold | | | 46642-0 | 12,10 | 30,28 |
| Alu bronze hell alu bonze light | | 2,5 m** | 46644-4 | 13,72 | 34,30 |
| Alu bronze dunkel alu bonze dark | | | 46646-8 | 13,72 | 34,30 |
| Edelstahl matt stainless steel matt | 7 mm | NEU! 1,0 m | 72366-0 | 20,88 | 20,88 |
| | | 2,5 m | 36430-6 | 20,88 | 52,20 |
| | | NEU! 3,0 m * | 72368-4 | 20,88 | 62,64 |
| * 3,0 m-Ware ist nur per Spedition lieferbar (gesonderte Transportkosten) 3,0 m profiles are only available per forwarding agency (separate transport costs) | | | | | |



Profil biegen - auf Anfrage/ bent profile - on request

483 Befestigungsdübel für T-Profile

fixing dowel for T-profiles

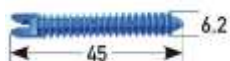

| Abmaß/dimension | Stk./Verpack. pcs./pack | Art./ref. | €/Btl./bag |
|-----------------|----------------------------|-----------|------------|
| 45 x 6,2 mm | Btl./bag à 10 | 70988-6 | 21,06 |

10. LÄUFERSTANGEN AUS MESSING & EDELSTAHL

10. STAIR RODS OUT OF BRASS + STAINLESS STEEL



10. LÄUFERSTANGEN/ 10. STAIR RODS

Achtung: Der Aufpreis für die Anfertigung von Sonderlängen beträgt generell 15% zuzügl. Verschnitt!

Note: There is a 15% surcharge for special length cuts plus waste!

Der Läuferstangendurchmesser ist nach Läuferart und Verlegetechnik zu wählen! Wir beraten Sie gern!

Stair rod diameter should be selected according to type of carpet and laying technology! We advise you gladly!

Läuferstange Ø 10 mm

stair rod Ø 10 mm

| Material/material | L / l (m) | Art./ref. | € |
|-------------------|-----------|-----------|---|
|-------------------|-----------|-----------|---|

74 Läuferstange Ø 10 x 0,8 mm Messing/ stair rod Ø 10 x 0,8 mm brass

Abschlussknöpfe werden in die Gesamtlänge eingerechnet
endings are included in the full length



| | | | |
|--|------|---------|-------|
| Messing-Rohr poliert, lackiert, inkl. Messingabschlussknöpfe brass pipe, polished, painted, with brass-endings | 0,75 | 05770-3 | 12,22 |
| | 0,8 | 05780-2 | 13,00 |
| | 0,9 | 05790-1 | 14,62 |
| | 1,0 | 05800-7 | 16,18 |
| | 1,1 | 05810-6 | 17,90 |
| | 1,2 | 05820-5 | 19,44 |
| Messing-Rohr mit Stahlkern poliert, lackiert, inkl. Messingabschlussknöpfe brass pipe with steel core, polished, painted, with brass-endings | 0,75 | 05813-7 | 14,20 |
| | 0,8 | 05814-4 | 15,16 |
| | 0,9 | 05815-1 | 17,00 |
| | 1,0 | 05816-8 | 18,96 |
| | 1,1 | 05817-5 | 20,88 |
| | 1,2 | 05818-2 | 22,78 |
| | 1,3 | 05830-4 | 21,08 |

371 Läuferstange Ø 10 x 1,5 mm Edelstahl poliert/ stair rod Ø 10 x 1,5 mm stainless steel polished

Abschlussknöpfe werden in die Gesamtlänge eingerechnet
endings are included in the full length



| | | | |
|--|------|---------|-------|
| Edelstahl-Rohr poliert inkl. vernickelter Abschlussknöpfe stainless steel pipe polished, with nickel plated endings | 0,75 | 66346-1 | 16,44 |
| | 0,8 | 66348-5 | 17,50 |
| | 0,9 | 66350-8 | 18,90 |
| | 1,0 | 66352-2 | 21,06 |
| | 1,1 | 66354-6 | 23,16 |
| | 1,2 | 66356-0 | 25,26 |
| | 1,3 | 66358-4 | 27,36 |

75 Läuferstange Ø 10 x 1,5 mm Edelstahl matt/ stair rod Ø 10 x 1,5 mm stainless steel matt

Abschlussknöpfe werden in die Gesamtlänge eingerechnet
endings are included in the full length



| | | | |
|--|------|---------|-------|
| Edelstahl-Rohr matt inkl. matter vernickelter Abschlussknöpfe stainless steel pipe matt, with mat nickel plated endings | 0,75 | 38820-3 | 12,58 |
| | 0,8 | 38830-2 | 13,42 |
| | 0,9 | 38840-1 | 15,08 |
| | 1,0 | 05450-4 | 16,80 |
| | 1,1 | 38850-0 | 18,46 |
| | 1,2 | 38860-9 | 20,16 |
| | 1,3 | 38870-8 | 21,82 |

429 Läuferstange Ø 10 x 0,8 mm Messing brüniert/ stair rod Ø 10 x 0,8 mm brass burnished

Abschlussknöpfe werden in die Gesamtlänge eingerechnet
endings are included in the full length

| | | | |
|---|-----|---------|-------|
| Messing-Rohr brüniert, mit Stahlkern inkl. brüniertes Abschlussknöpfe burnished brass pipe, with steel core, with burnished brass-endings | 1,0 | 05100-8 | 28,28 |
|---|-----|---------|-------|

Brünier-Farbtone kann variieren/ colour of burnished brass can vary

Lieferzeit auf Anfrage/ delivery time on request

76 Stahl-Läuferstange mit Dekorbeschichtung Ø 10 x 1,5 mm

steel stair rod with decor coating
Ø 10 x 1,5 mm

inkl. Messingabschlussknöpfe
with brass endings

| | | | |
|----------------------------|-----|---------|-------|
| schwarz matt/ black matt | 1,0 | 05300-2 | 13,08 |
| Kupfer antik/ copper antik | | 05350-7 | |
| weiß/ white | | 05400-9 | |

Nicht für den Außenbereich geeignet/ not suitable for outdoor use

10. LÄUFERSTANGEN/ 10. STAIR RODS

Zubehör für Läuferstange Ø 10 mm

accessories for stair rod Ø 10 mm

189 Kugelöse für Läuferstange Ø 10 mm, gedreht/ ball eyelet for stair rod Ø 10 mm, twisted

gedrehte Ausführung mit
Stockschraube M4
twisted execution with hanger bolt M4



Feststellschraube/
locking screw

Brünier-Farbtön kann variieren
colour of burnished brass can vary

Lieferzeit für brüniert auf Anfrage/
delivery time for burnished brass on
request

| Material/material | Abpackung/ unit | Art./ref. | € |
|--|-----------------|-----------|---------------|
| Messing , poliert, lackiert brass, polished, painted | 1 Stück /pcs. | 05500-6 | 2,10/St./pcs. |
| Messing mit Feststellschraube , poliert, lackiert, brass with locking screw, polished, painted, | 1 Stück /pcs. | 05700-0 | 3,46/St./pcs. |
| vernickelt nickel plated | 1 Stück /pcs. | 05600-3 | 2,44/St./pcs. |
| vernickelt mit Feststellschraube nickel plated with locking screw | 1 Stück /pcs. | 05705-5 | 3,74/St./pcs. |
| vernickelt matt nickel plated mat | 1 Stück /pcs. | 38890-6 | 5,02/St./pcs. |
| vernickelt matt mit Feststellschraube nickel plated mat with locking screw | 1 Stück /pcs. | 38900-2 | 6,30/St./pcs. |
| brüniert burnished brass | 1 Stück /pcs. | 05710-9 | 5,10/St./pcs. |
| brüniert mit Feststellschraube burnished brass with locking screw | 1 Stück /pcs. | 05720-8 | 6,46/St./pcs. |

Kugelöse Ø 10 mm, gegossen / ball eyelet Ø 10 mm casted

| | | | |
|---|---------------|---------|---------------|
| Messing poliert, lackiert brass polished, painted | 1 Stück /pcs. | 39310-8 | 1,74/St./pcs. |
| vernickelt nickel plated | 1 Stück /pcs. | 39312-2 | 2,00/St./pcs. |

Eindrehwerkzeug für Kugelösen 10 mm, Messing/ tool for ball eyelets 10 mm, brass

zur Verwendung im Akkuschauber/ for use in electric drills

39150-0 40,90/St./pcs.

73 Klappöse Ø 10 mm, offen/ folding eyelet Ø 10 mm, open

inkl. Schrauben + Dübel
incl. screws + dowels



Brünier-Farbtön kann variieren/
colour of burnished brass can vary

| | | | |
|---|-------------|---------|-----------------|
| Messing poliert, lackiert brass polished, painted | 1 Paar/pair | 05030-8 | 19,78/Paar/pair |
| vernickelt nickel plated | 1 Paar/pair | 05031-5 | 25,94/Paar/pair |
| vernickelt matt nickel plated mat | 1 Paar/pair | 38910-1 | 36,92/Paar/pair |
| brüniert burnished brass | 1 Paar/pair | 05050-6 | 29,38/Paar/pair |

Lieferzeit für brüniert auf Anfrage/ delivery time for burnished brass on request

190 Klappöse Ø 10 mm, geschlossen/ folding eyelet Ø 10 mm, closed

inkl. Schrauben + Dübel
incl. screws + dowels



Brünier-Farbtön kann variieren/
colour of burnished brass can vary

| | | | |
|---|-------------|---------|-----------------|
| Messing poliert, lackiert brass polished, painted | 1 Paar/pair | 05040-7 | 19,78/Paar/pair |
| vernickelt nickel plated | 1 Paar/pair | 05041-4 | 25,94/Paar/pair |
| vernickelt matt nickel plated mat | 1 Paar/pair | 38920-0 | 36,92/Paar/pair |
| brüniert burnished brass | 1 Paar/pair | 05060-5 | 29,38/Paar/pair |

Lieferzeit für brüniert auf Anfrage/ delivery time for burnished brass on request

10. LÄUFERSTANGEN/ 10. STAIR RODS

Achtung: Der Aufpreis für die Anfertigung von Sonderlängen beträgt generell 15% zuzügl. Verschnitt!

Note: There is a 15% surcharge for special length cuts plus waste!

Der Läuferstangendurchmesser ist nach Läuferart und Verlegetechnik zu wählen! Wir beraten Sie gern!

Stair rod diameter should be selected according to type of carpet and laying technology! We advise you gladly!

| Läuferstange 13 mm | | | |
|--------------------|-----------|-----------|---|
| stair rod Ø 13 mm | | | |
| Material/material | L / l (m) | Art./ref. | € |

197 Läuferstange Ø 13 x 1,0 mm Messing/ stair rod Ø 13 x 1,0 mm brass

Abschlussknöpfe werden in die Gesamtlänge eingerechnet
endings are included in the full length



| | | | |
|--|-----|---------|-------|
| Messing-Rohr poliert, lackiert, inkl. Abschlussknöpfe brass pipe, polished, painted, incl. endings | 0,9 | 05822-9 | 22,88 |
| | 1,0 | 05823-6 | 25,34 |
| | 1,2 | 05824-3 | 30,46 |
| Messing-Rohr mit Stahlkern, poliert, lack., inkl. Abschlussknöpfe brass pipe with steel core, polished, painted, incl. endings | 0,9 | 39100-5 | 29,88 |
| | 1,0 | 39110-4 | 33,16 |
| | 1,5 | 39120-3 | 49,66 |

379 Läuferstange Ø 13 x 1,0 mm Edelstahl poliert/ stair rod Ø 13 x 1,0 mm stainless steel polished

Abschlussknöpfe werden in die Gesamtlänge eingerechnet
endings are included in the full length



| | | | |
|---|-----|---------|-------|
| Edelstahl-Rohr poliert inkl. vernickelter Abschlussknöpfe stainless steel pipe, polished, incl. endings | 0,9 | 66466-6 | 23,94 |
| | 1,0 | 66468-0 | 26,56 |
| | 1,2 | 66472-7 | 31,86 |
| Edelstahl-Rohr poliert mit Stahlkern, inkl. vernickelter Abschlussknöpfe stainless steel pipe, polished, with steel core, incl. endings | 0,9 | 66482-6 | 30,44 |
| | 1,0 | 66484-0 | 33,34 |
| | 1,5 | 66490-1 | 52,26 |

430 Läuferstange Ø 13 x 1,0 mm Edelstahl matt/ stair rod Ø 13 x 1,0 mm stainless steel mat

Abschlussknöpfe werden in die Gesamtlänge eingerechnet
endings are included in the full length



| | | | |
|--|-----|---------|-------|
| Edelstahl-Rohr matt inkl. matter vernickelter Abschlussknöpfe stainless steel pipe, mat, incl. mat endings | 0,9 | 67538-9 | 22,72 |
| | 1,0 | 67540-2 | 25,26 |
| | 1,2 | 67544-0 | 30,28 |
| Edelstahl-Rohr matt mit Stahlkern, inkl. matter vernickelter Abschlussknöpfe stainless steel pipe, mat, with steel core, incl. mat endings | 0,9 | 67554-9 | 28,82 |
| | 1,0 | 67556-3 | 32,02 |
| | 1,5 | 67560-0 | 48,06 |

431 Läuferstange Ø 13 x 1,0 mm Messing brüniert/ stair rod Ø 13 x 1,0 mm brass burnished

Abschlussknöpfe werden in die Gesamtlänge eingerechnet
endings are included in the full length

Brünier-Farbtton kann variieren/ colour of burnished brass can vary

| | | | |
|---|-----|---------|-------|
| Messing-Rohr brüniert inkl. brüniertes Abschlussknöpfe burnished brass pipe, with burnished brass-endings | 1,0 | 67576-1 | 34,36 |
| | 1,0 | 67592-1 | 42,16 |

Lieferzeit auf Anfrage/ delivery time on request

10. LÄUFERSTANGEN/ 10. STAIR RODS

Zubehör für Läuferstange Ø 13 mm

accessories for stair rod Ø 13 mm

198 Kugelöse 13 mm, gedreht/ ball eyelet 13 mm, twisted

gedrehte Ausführung mit
Stockschraube M4
twisted execution with
hanger bolt M4



Feststellschraube/
locking screw

**Brünier-Farbtön kann
variieren/** colour of burnished
brass can vary

| Material/material | Abpackung/ unit | Art./ref. | € |
|--|-----------------|-----------|----------------|
| Messing poliert, lackiert brass, polished, painted | 1 Stück /pcs. | 05825-0 | 4,26/St./pcs. |
| Messing mit Feststellschraube, poliert, lackiert, brass with locking screw, polished, painted | 1 Stück /pcs. | 05850-2 | 6,82/St./pcs. |
| vernickelt nickel plated | 1 Stück /pcs. | 39230-9 | 6,60/St./pcs. |
| vernickelt mit Feststellschraube/ nickel plated, with locking screw | 1 Stück /pcs. | 39235-4 | 10,56/St./pcs. |
| vernickelt matt nickel plated mat | 1 Stück /pcs. | 39238-5 | 6,76/St./pcs. |
| vernickelt matt mit Feststellschraube nickel plated mat with locking screw | 1 Stück /pcs. | 39239-2 | 10,70/St./pcs. |
| brüniert burnished brass | 1 Stück /pcs. | 39236-1 | 7,38/St./pcs. |
| brüniert mit Feststellschraube burnished brass with locking screw | 1 Stück /pcs. | 39237-8 | 9,92/St./pcs. |

Lieferzeit für brüniert auf Anfrage/ delivery time for burnished brass on request

Eindrehwerkzeug für Kugelösen 13 mm, Messing/ tool for ball eyelets 13 mm, brass

zur Verwendung im Akkuschauber/ for use in electric drills

72254-0 53,16/St./pcs.

199 Klappöse Ø 13 mm, offen/ folding eyelets Ø 13 mm brass, open

inkl. Schrauben + Dübel
incl. screws + dowels



**Brünier-Farbtön kann
variieren/** colour of burnished
brass can vary

| | | | |
|--|-------------|---------|-----------------|
| Messing poliert, lackiert brass, polished, painted | 1 Paar/pair | 39130-2 | 25,66/Paar/pair |
| vernickelt nickel plated | 1 Paar/pair | 39240-8 | 31,00/Paar/pair |
| vernickelt matt nickel plated mat | 1 Paar/pair | 39131-9 | 42,00/Paar/pair |
| brüniert burnished brass | 1 Paar/pair | 39132-6 | 35,26/Paar/pair |

Lieferzeit für brüniert auf Anfrage/ delivery time for burnished brass on request

200 Klappöse Ø 13 mm, geschlossen/ folding eyelets Ø 13 mm brass, closed

inkl. Schrauben + Dübel
incl. screws + dowels



**Brünier-Farbtön kann
variieren/** colour of burnished
brass can vary

| | | | |
|--|-------------|---------|-----------------|
| Messing poliert, lackiert brass, polished, painted | 1 Paar/pair | 39140-1 | 25,66/Paar/pair |
| vernickelt nickel plated | 1 Paar/pair | 39245-3 | 31,00/Paar/pair |
| vernickelt matt nickel plated mat | 1 Paar/pair | 39141-8 | 42,00/Paar/pair |
| brüniert burnished brass | 1 Paar/pair | 39142-5 | 35,26/Paar/pair |

Lieferzeit für brüniert auf Anfrage/ delivery time for burnished brass on request

10. LÄUFERSTANGEN/ 10. STAIR RODS

Achtung: Der Aufpreis für die Anfertigung von Sonderlängen beträgt generell 15% zuzügl. Verschnitt!

Note: There is a 15% surcharge for special length cuts plus waste!

Der Läuferstangendurchmesser ist nach Läuferart und Verlegetechnik zu wählen! Wir beraten Sie gern!

Stair rod diameter should be selected according to type of carpet and laying technology! We advise you gladly!

Zubehör für Läuferverlegung

accessories for runners laying

| Material/material | Art./ref. | Abpackung/unit | € |
|-------------------|-----------|----------------|---|
|-------------------|-----------|----------------|---|

6 8 Teppichschraube mit Metallbuchse/ carpet screw with metal casing



| | | | |
|------------------------------------|---------|--|------------------|
| Messing brass | 20562-3 | SB-Beutel à 10 Stk./ self-service bag à 10 pcs. | 35,70/Btl./bag |
| | 20561-6 | Karton à 50 Stk./ box à 50 pcs. | 171,42/Kart./box |
| vernickelt nickel plated | 20565-4 | Karton à 50 Stk./ box à 50 pcs. | 181,74/Kart./box |

Unterlegscheibe für Teppichschraube/ washer for carpet screw



| | | | |
|------------------------------------|---------|--|-----------------|
| Messing brass | 20563-0 | SB-Beutel à 10 Stk./ self-service bag à 10 pcs. | 11,48/Btl./bag |
| | 20564-7 | Karton à 50 Stk./ box à 50 pcs. | 41,20/Kart./box |
| vernickelt nickel plated | 20566-1 | Karton à 50 Stk./ box à 50 pcs. | 44,24/Kart./box |

6 9 Teppichnagel/ carpet nail



| | | | |
|--|---------|--|-----------------|
| messingfarben 3,0 x 30 brass coloured 3,0 x 30 | 20574-6 | SB-Beutel à 10 Stk./ self-service bag à 10 pcs. | 5,40/Btl./bag |
| | 20570-8 | Karton à 100 Stk./ box à 100 pcs. | 29,90/Kart./box |
| vernickelt 3,0 x 30 nickel plated 3,0 x 30 | 20582-1 | SB-Beutel à 10 Stk./ self-service bag à 10 pcs. | 5,88/Btl./bag |
| | 20578-4 | Karton à 100 Stk./ box à 100 pcs. | 34,76/Kart./box |

Dreikantläuferstange 16 x 16 mm

triangular stair rod 16 x 16 mm

| Material/material | L / l (m) | Art./ref. | € |
|-------------------|-----------|-----------|---|
|-------------------|-----------|-----------|---|

7 0 Dreikantläuferstange 16 x 16 mm/ triangular stair rod 16 x 16 mm



Brünier-Farbton kann variieren/ colour of burnished brass can vary

| | | | |
|---|-----|---------|--------|
| Eisenrohr mit nahtlosem Messing-Überzug , poliert, lackiert steel pipe, brass plated, polished, painted | 1,0 | 05003-2 | 26,70 |
| | 2,5 | 05000-1 | 66,76 |
| vernickelt nickel plated | 1,0 | 05002-5 | 39,76 |
| | 2,5 | 05001-8 | 99,62 |
| brüniert burnished brass | 1,0 | 05006-3 | 44,34 |
| | 2,5 | 05007-0 | 110,82 |

Nicht für den Außenbereich geeignet/ not suitable for outdoor use

Zubehör für Dreikantläuferstange 16 x 16 mm

accessories for triangular stair rod 16 x 16 mm

| Material/material | Art./ref. | Abpackung/unit | € |
|-------------------|-----------|----------------|---|
|-------------------|-----------|----------------|---|

180 Dreikantklappöse 16 x 16 mm, geschlossen/ triangular folding eyelets 16 x 16 mm, closed

inkl. Dübel & Schrauben
incl. screws + dowels



| | | | |
|---|---------|--------------|-----------------|
| Messing poliert, lackiert brass polished, painted | 05020-9 | 1 Paar/ pair | 26,74/Paar/pair |
| vernickelt nickel plated | 05021-6 | 1 Paar/ pair | 35,08/Paar/pair |
| brüniert burnished brass | 05022-3 | 1 Paar/ pair | 36,92/Paar/pair |

Brünier-Farbton kann variieren/ colour of burnished brass can vary

10. LÄUFERSTANGEN/ 10. STAIR RODS

Achtung: Der Aufpreis für die Anfertigung von Sonderlängen beträgt generell 15% zuzügl. Verschnitt!

Note: There is a 15% surcharge for special length cuts plus waste!

Der Läuferstangendurchmesser ist nach Läuferart und Verlegetechnik zu wählen! Wir beraten Sie gern!

Stair rod diameter should be selected according to type of carpet and laying technology! We advise you gladly!

Läuferstange Ø 16 mm

stair rod Ø 16 mm

| Material/material | L / l (m) | Art./ref. | € |
|-------------------|-----------|-----------|---|
|-------------------|-----------|-----------|---|

71 Läuferstange Ø 16 x 3 mm Messing/ stair rod Ø 16 x 3 mm brass

poliert, lackiert, 3 mm Wandstärke, ohne Abschlussknöpfe
 polished, painted, 3 mm walls, without endings

| | | |
|-----|---------|-------|
| 1,0 | 05451-1 | 58,16 |
|-----|---------|-------|

Die Fertigung erfolgt objektbezogen/
 manufactured on customers order







Länge = Rohrlänge **ohne** Abschlussknöpfe
 length = pipe length without endings

Abschlussknöpfe für Messingläuferstangen Ø 16 x 3 mm/ endings for 16 x 3 mm brass stair rod

Messing gedreht,
 poliert, lackiert
 16 mm brass, twisted execution,
 polished, painted



| | | | |
|-----------------------------------|---|---------|-----------------|
| 1. Knaufform knob shape |  | 05801-4 | 22,10/Paar/pair |
| 2. Kronenform crown shape |  | 05802-1 | 30,80/Paar/pair |
| 3. Zepterform scepter shape |  | 05803-8 | 30,80/Paar/pair |
| 4. Imperial imperial shape |  | 05806-9 | 61,66/Paar/pair |
| 5. Eichelform oak shape |  | 05804-5 | 22,10/Paar/pair |
| 6. Zylinderform cylinder shape |  | 05805-2 | 19,30/Paar/pair |

72 Läuferstange Ø 16 x 1 mm Edelstahl matt/ stair rod Ø 16 x 1 mm stainless steel matt

ohne Abschlussknöpfe
 without endings

Länge = Rohrlänge **ohne**
 Abschlussknöpfe
 length = pipe length without
 endings



| | | |
|------|---------|-------|
| 0,75 | 38930-9 | 18,98 |
| 0,8 | 38940-8 | 20,18 |
| 0,9 | 38950-7 | 22,72 |
| 1,0 | 05015-5 | 25,26 |
| 1,1 | 38960-6 | 27,76 |
| 1,2 | 38970-5 | 30,34 |
| 1,3 | 38980-4 | 32,80 |

194 Läuferstange Ø 16 x 2 mm Edelstahl matt/ stair rod Ø 16 x 2 mm stainless steel matt

ohne Abschlussknöpfe
 without endings

Länge = Rohrlänge **ohne**
 Abschlussknöpfe
 length = pipe length without
 endings



| | | |
|-----|---------|-------|
| 1,0 | 05014-8 | 35,34 |
| 1,5 | 38990-3 | 53,00 |
| 2,0 | 39000-8 | 70,62 |

Abschlussknopf Zylinderform für Edelstahl-Läuferstangen 16 x 1 und 16 x 2 mm

endings cylinder shape for stainless steel stair rod 16 x 1 and 16 x 2 mm



| | | |
|---|---------|-----------------|
| vernickelt nickel plated | 05016-2 | 20,10/Paar/pair |
| vernickelt matt nickel plated mat | 39010-7 | 24,06/Paar/pair |

10. LÄUFERSTANGEN/ 10. STAIR RODS

Zubehör für Läuferstange Ø 16 mm

accessories for stair rod Ø 16 mm

| Material/material | Abpackung/ unit | Art./ref. | € |
|-------------------|--------------------|-----------|---|
|-------------------|--------------------|-----------|---|

182 Kugelöse für Läuferstange Ø 16 mm, gedreht/ ball eyelet for stair rod Ø 16 mm, twisted

gedrehte Ausführung mit
Stockschraube M5 x 30 für
stabilere Befestigung
twisted execution with hanger
bolt M5 x 30 for stronger fixing



| | | | |
|--|---------------|---------|----------------|
| Messing , poliert, lackiert brass, polished, painted | 1 Stück /pcs. | 05826-7 | 7,84/St./pcs. |
| Messing mit Feststellschraube brass with locking screw | 1 Stück /pcs. | 05827-4 | 9,16/St./pcs. |
| vernickelt nickel plated | 1 Stück /pcs. | 05828-1 | 9,16/St./pcs. |
| vernickelt mit Feststellschraube nickel plated with locking screw | 1 Stück /pcs. | 05829-8 | 10,54/St./pcs. |
| vernickelt matt nickel plated mat | 1 Stück /pcs. | 39020-6 | 13,20/St./pcs. |
| vernickelt matt mit Feststellschraube nickel plated mat with locking screw | 1 Stück /pcs. | 39030-5 | 14,54/St./pcs. |

Kugelöse Ø 16 mm, gegossen / ball eyelet Ø 16 mm casted

Stockschraube 4 x 20 mm
hanger bolt 4 x 20 mm

| | | | |
|---|---------------|---------|---------------|
| Messing , poliert, lackiert brass polished, painted | 1 Stück /pcs. | 05811-3 | 5,80/St./pcs. |
| vernickelt/ nickel plated | 1 Stück /pcs. | 05812-0 | 6,74/St./pcs. |

Eindrehwerkzeug für Kugelösen 16mm, Messing/ tool for ball eyelets 16 mm, brass

zur Verwendung im Akkuschauber/ for use in electric drills

| | |
|---------|----------------|
| 72256-4 | 65,42/St./pcs. |
|---------|----------------|

183 Klappöse, große Ausführung Ø 16 mm, offen/ folding eyelets large Ø 16 mm, open

inkl. Schr. + Dübel
incl. screws + dowels



| | | | |
|---|-------------|---------|-----------------|
| Messing glatt/ brass smooth | 1 Paar/pair | 05510-5 | 37,26/Paar/pair |
| Messing mit Dekor/ brass with decor | 1 Paar/pair | 05530-3 | 38,48/Paar/pair |
| vernickelt glatt/ nickel plated smooth | 1 Paar/pair | 05520-4 | 42,76/Paar/pair |
| vernickelt mit Dekor/ nickel plated with decor | 1 Paar/pair | 05540-2 | 43,92/Paar/pair |
| vernickelt matt glatt/ nickel plated smooth | 1 Paar/pair | 39040-4 | 52,00/Paar/pair |
| vernickelt matt mit Dekor/ nickel plated with decor | 1 Paar/pair | 39050-3 | 47,72/Paar/pair |

434 Klappöse, große Ausführung Ø 16 mm, geschlossen/ folding eyelets large Ø 16 mm, closed

inkl. Schr. + Dübel
incl. screws + dowels



| | | | |
|--|-------------|---------|-----------------|
| Messing glatt/ brass smooth | 1 Paar/pair | 39060-2 | 37,26/Paar/pair |
| Messing mit Dekor/ brass with decor | 1 Paar/pair | 39070-1 | 38,48/Paar/pair |
| vernickelt glatt/ nickel plated smooth | 1 Paar/pair | 39065-7 | 42,76/Paar/pair |
| vernickelt matt glatt/ nickel plated smooth | 1 Paar/pair | 39075-6 | 52,00/Paar/pair |

10. LÄUFERSTANGEN/ 10. STAIR RODS

Achtung: Der Aufpreis für die Anfertigung von Sonderlängen beträgt generell 15% zuzügl. Verschnitt!

Note: There is a 15% surcharge for special length cuts plus waste!

Der Läuferstangendurchmesser ist nach Läuferart und Verlegetechnik zu wählen! Wir beraten Sie gern!

Stair rod diameter should be selected according to type of carpet and laying technology! We advise you gladly!

Läuferstange Ø 25 mm

stair rod Ø 25 mm

| Material/material | L / l (m) | Art./ref. | € |
|-------------------|-----------|-----------|---|
|-------------------|-----------|-----------|---|

184 Läuferstange Ø 25 x 4 mm Messing/ stair rod Ø 25 x 4 mm brass

4 mm Wandstärke/ 4 mm walls



| | | | |
|---|-----|---------|----------|
| Messing, poliert, lackiert brass polished, painted | 1,0 | 39250-7 | 125,30/m |
|---|-----|---------|----------|

Die Fertigung erfolgt objektbezogen/ manufactured on customers order

187 Abschlussknopf Imperial 25 mm/ endings imperial 25 mm



| | | |
|--|---------|-----------------|
| Messing poliert, lackiert brass polished, painted | 39266-8 | 61,66/Paar/pair |
|--|---------|-----------------|

185 Profi-Kugelöse 25 mm, gedreht/ profi-ball eyelet 25 mm, twisted

gedrehte Ausführung mit
Stockschraube M6 x 50
für stabilere Befestigung
twisted version with
hanger bolt M6 x 50
for stronger fastening



| | | |
|---|---------|----------------|
| Messing, poliert, lackiert brass polished, painted | 39262-0 | 30,74/St./pcs. |
|---|---------|----------------|

| | | |
|---|---------|----------------|
| Messing mit Feststellschraube brass with locking screw | 39264-4 | 35,18/St./pcs. |
|---|---------|----------------|

186 Klappöse Ø 25 mm, große Ausführung/ folding eyelets large Ø 25 mm

inkl. Schrauben+Dübel
incl. screws+dowels



| | | |
|--|---------|-----------------|
| Messing poliert, lackiert, offen, mit Dekor brass polished, painted, open, with decor | 39260-6 | 53,70/Paar/pair |
|--|---------|-----------------|

für Läuferbreiten bis 2,9 m ohne Mittelöse
im hochwertigen Objektbereich

for carpets with a width of 2,9 m without middle fixings in grand buildings



Staatstheater Warschau/ state theatre Warsaw

11. REPARATURWINKEL FÜR TREPPEN & PVC-PROFILE

11. REPAIR ANGLES FOR STAIRS + PVC-FILES

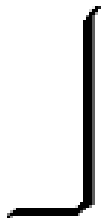

11. REPARATURWINKEL & PVC-PROFILE/ 11. REPAIR ANGLES + PVC-FILES

Schrauben + Dübel
siehe Abschnitt 12!
screws + dowels, see section 12!

| Reparaturwinkel Edelstahl für Treppensanierung | | | | | |
|---|-----------|-----------|--------------------|---|--|
| repair angle steel stainless steel for staircase renovation | | | | | |
| Material/material | Art./ref. | L / l (m) | Stk./VE / pcs/unit | € | |

336 **EDELSTAHL**-Reparaturwinkel **B20** für Betontreppen

stainless steel repair angle
B20 for concrete stairs

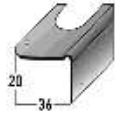

| 20 mm Nase 20 mm nose | ohne Befestigungszubehör without fixing accessories | 00973-3 | 1,0 | 25 | 19,04 |
|--------------------------|--|---------|------|----|-------|
| | | 00982-1 | 1,25 | | 23,58 |
| | | 00975-1 | 2,0 | | 35,70 |

Extra Befestigungszubehör siehe
Abschnitt 12! / Extra fixing accessories,
see section 12!

| Reparaturwinkel Stahl verzinkt für Treppensanierung | | | | | |
|--|-----------|-----------|--------------------|---|--|
| repair angle steel galvanized for staircase renovation | | | | | |
| Material/material | Art./ref. | L / l (m) | Stk./VE / pcs/unit | € | |

243 Reparaturwinkel **H15** für Holztreppen

repair angle H15
for wooden stairs



| 15 mm Nase 15 mm nose | inkl. Ringnägel incl. ruffled nails | 00942-9 | 1,0 | 25 | 6,34 |
|--------------------------|--|---------|-----|----|-------|
| | | 00943-6 | 2,0 | | 12,76 |
| | ohne Befestigungszubehör without fixing accessories | 00950-4 | 1,0 | 25 | 6,02 |
| | | 00951-1 | 2,0 | | 12,10 |

119 Reparaturwinkel **H20** für Holztreppen

repair angle H20
for wooden stairs



| 20 mm Nase 20 mm nose | inkl. Ringnägel incl. ruffled nails | 00910-8 | 1,0 | 25 | 6,34 |
|--------------------------|--|---------|------|----|-------|
| | | 00983-0 | 1,25 | | 8,32 |
| | | 00915-3 | 2,0 | | 12,76 |
| | ohne Befestigungszubehör without fixing accessories | 00955-9 | 1,0 | 25 | 6,02 |
| | | 00984-9 | 1,25 | | 7,84 |
| | | 00957-3 | 2,0 | | 12,10 |

242 Reparaturwinkel **H38** für Holztreppen

repair angle H38
for wooden stairs



| 38 mm Nase 38 mm nose | inkl. Ringnägel incl. ruffled nails | 00920-7 | 1,0 | 25 | 8,10 |
|--------------------------|--|---------|-----|----|-------|
| | | 00925-2 | 2,0 | | 16,30 |
| | ohne Befestigungszubehör without fixing accessories | 00960-3 | 1,0 | 25 | 7,36 |
| | | 00961-0 | 2,0 | | 14,62 |

244 Reparaturwinkel **B15** für Betontreppen

repair angle B15
for concrete stairs

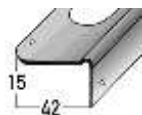

| 15 mm Nase 15 mm nose | inkl. Schrauben + Dübel incl. screws + dowels | 00945-0 | 1,0 | 25 | 8,54 |
|--------------------------|--|---------|-----|----|-------|
| | | 00946-7 | 2,0 | | 16,74 |
| | ohne Befestigungszubehör without fixing accessories | 00965-8 | 1,0 | 25 | 7,58 |
| | | 00966-5 | 2,0 | | 15,22 |

120 Reparaturwinkel **B20** für Betontreppen

repair angle B20
for concrete stairs

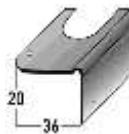

| 20 mm Nase 20 mm nose | inkl. Schrauben + Dübel incl. screws + dowels | 00930-6 | 1,0 | 25 | 8,54 |
|--------------------------|--|---------|------|----|-------|
| | | 00985-8 | 1,25 | | 11,08 |
| | | 00935-1 | 2,0 | | 16,74 |
| | ohne Befestigungszubehör without fixing accessories | 00970-2 | 1,0 | 25 | 7,58 |
| | | 00986-7 | 1,25 | | 9,90 |
| | | 00972-6 | 2,0 | | 15,22 |

432 **RUND**-Reparaturwinkel **B25x40, R 7,5** für DEBOLON-TK 3

round repair angle
B25x40 R 7,5
for Debolon-TK 3



| 25 mm Nase 25 mm nose | inkl. Schrauben + Dübel incl. screws + dowels | 00979-7 | 1,0 | 25 | 13,70 |
|--------------------------|--|---------|------|----|-------|
| | | 00987-6 | 1,25 | | 18,74 |
| | | 00981-2 | 2,0 | | 27,16 |
| | ohne Befestigungszubehör without fixing accessories | 00976-0 | 1,0 | 25 | 12,80 |
| | | 00988-5 | 1,25 | | 16,62 |
| | | 00978-8 | 2,0 | | 25,64 |

11. REPARATURWINKEL & PVC-PROFILE / 11. REPAIR ANGLES + PVC-PROFILES

| PVC-Profil | | | | | |
|-------------------|--------------------|-----------|---------------|-----------|-------------|
| PVC profiles | | | | | |
| Material/material | Stk./VE / pcs/unit | L / l (m) | Farbe/ colour | Art./ref. | €/Stk./pcs. |

356 PVC-Einfassleiste, einseitig

PVC insert profile, single-sided

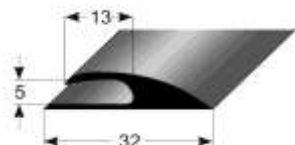

| | | | | | |
|---|----|-------|---------------|---------|-------|
| einseitig, ohne Kleber, weich PVC, für Beläge bis 5 mm single-sided, without adhesive, soft PVC, for floorings up to 5 mm | 20 | 2,7 m | grau grey | 52848-7 | 10,90 |
| | | | schwarz black | 52850-0 | |
| | | | braun brown | 52852-4 | |
| | | | beige beige | 52854-8 | |

357 PVC-Einfassleiste, doppelseitig

PVC insert profile, double-sided

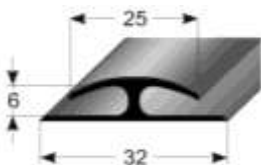

| | | | | | |
|--|----|-------|---------------|---------|------|
| doppelseitig, ohne Kleber, weich PVC, für Beläge bis 6 mm double-sided, without adhesive, soft PVC, for floorings up to 6 mm | 20 | 2,7 m | grau grey | 52856-2 | 9,30 |
| | | | schwarz black | 52858-6 | |
| | | | braun brown | 52860-9 | |
| | | | beige beige | 52862-3 | |

358 PVC-Übergangprofil 30 mm

PVC connecting profile 30 mm



| | | | | | |
|--|----|-------|-------------|---------|------|
| hart PVC, gelocht hard PVC, drilled | 20 | 1,0 m | grau grey | 52864-7 | 2,96 |
| | | | braun brown | 52866-1 | |
| | | | beige beige | 52868-5 | |

246 PVC-Winkel für Stufenmatten, selbstklebend / PVC angle for stair matts, self-adhesive



| | | | | | |
|---|----|--------|---|---------|-------|
| 23,5 x 53 mm, Oberfläche geriffelt, 40 mm Kleberbreite 23,5 x 53 mm, ribbed surface, 40 mm adhesive width | 10 | 0,63 m | unbestimmt, Recycling-material indefinite, recycled material | 52101-3 | 2,62 |
| | | 2,7 m | | 52102-0 | 11,24 |

11. REPARATURWINKEL & PVC-PROFILE/ 11. REPAIR ANGLES + PVC-FILES

| PVC-Profile | | | | | |
|-------------------|--------------------|-----------|---------------|-----------|---|
| PVC profiles | | | | | |
| Material/material | Stk./VE / pcs/unit | L / l (m) | Farbe/ colour | Art./ref. | € |

51 PVC-Knickwinkel 20 x 20 mm

PVC bending angle
20 x 20 mm

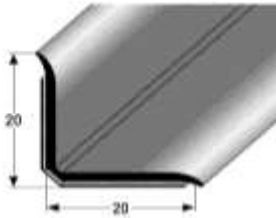

| | | | | | |
|---|---|-----------------------|-------------------------|---------|---------------------|
| selbstklebend weich PVC auf Rolle self-adhesive soft PVC rolled | 4 | Rolle/ roll à 25 m | grau/ grey | 57301-2 | 1,36/m 33,92/Ro. |
| | | | braun/ brown | 57303-6 | |
| | | | beige/ beige | 57304-3 | |
| | | | weiß/ white | 57308-1 | |
| | | | Eiche hell oak light | 57305-0 | 1,42/m 35,64/Ro. |

57 PVC-Sockelleiste 15 x 50 mm

PVC skirting 15 x 50 mm

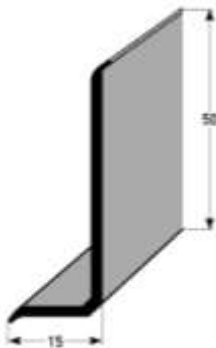

| | | | | | |
|--|---------|-----------------------|-----------------------------|---------|---------------------|
| ohne Kleber weich PVC auf Rolle without adhesive soft PVC rolled | 2 | Rolle/ roll à 50 m | grau/ grey | 58381-3 | 1,44/m 71,98/Ro. |
| | | | braun/ brown | 58383-7 | |
| | | | beige/ beige | 58384-4 | |
| | | | weiß/ white | 58388-2 | |
| | | | Eiche hell oak light | 58385-1 | |
| | | | Esche grau ash-tree grey | 58387-5 | |
| | | | Buche/ beech | 58389-9 | |
| Ahorn/ maple | 58420-9 | | | | |

Verlegehinweis:

Behandeln Sie raue und saugende Untergründe mit Grundierung nach Herstellervorschrift vor.

Fettige Stellen müssen entfettet bzw. isoliert werden.

Installation tip:

Treat rough and absorbent surfaces with primer. Follow the manufacturers directions.

Greasy surfaces need to be degreased before installation!

433 PVC-Hohlkehprofil 25 x 25 mm als Stützunterlage für Bodenbelagssockel

PVC hollow profile
25 x 25 mm
as floor to wall support

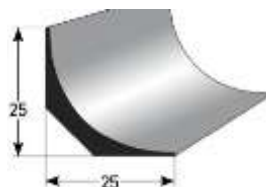

| | | | | | |
|-----------------------|---|-----------------------|------------------|---------|---------------------|
| weich-PVC soft PVC | 1 | Rolle/ roll à 25 m | schwarz black | 59502-1 | 3,30/m 82,48/Ro. |
|-----------------------|---|-----------------------|------------------|---------|---------------------|

für einen optimalen Übergang der Bodenbeläge vom Boden zur Wand
 for best edge linking carpets from floor to wall

11. REPARATURWINKEL & PVC-PROFILE/ 11. REPAIR ANGLES + PVC-FILES

PVC-Treppenkanten

PVC stair nosings

| Material/material | L / l (m) | Stk./VE / pcs/unit | Farbe/ colour | Art./ref. | € |
|-------------------|-----------|--------------------|---------------|-----------|---|
|-------------------|-----------|--------------------|---------------|-----------|---|

361 PVC-Treppenkante 30 x 45 x 3 mm/ PVC stair nosing 30 x 45 x 3 mm

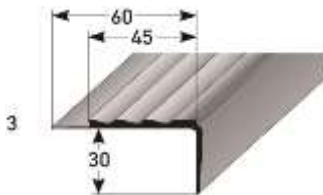

| | | | | | |
|--|-----|-------------------|----------------|---------|--------------------------|
| für Beläge bis 3 mm, weich PVC for floorings up to 3 mm, soft PVC | 2,5 | Kart./box à 30 | grau/ grey | 52800-5 | 7,78/m 19,50/St./pcs. |
| | | | schwarz/ black | 52802-9 | |
| | | | braun/ brown | 52804-3 | |
| | | | beige/ beige | 52806-7 | |

362 PVC-Treppenkante 45 x 35 x 2 mm/ PVC stair nosing 45 x 35 x 2 mm

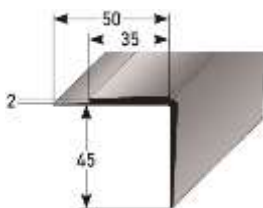

| | | | | | |
|--|-----|-------------------|----------------|---------|--------------------------|
| für Beläge bis 2 mm, weich PVC for floorings up to 2 mm, soft PVC | 2,5 | Kart./box à 30 | grau/ grey | 52808-1 | 8,18/m 20,54/St./pcs. |
| | | | schwarz/ black | 52810-4 | |
| | | | braun/ brown | 52812-8 | |
| | | | beige/ beige | 52814-2 | |

363 PVC-Treppenkante 42 x 45 x 3 mm/ PVC stair nosing 42 x 45 x 3 mm

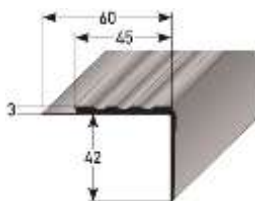

| | | | | | |
|--|-----|-------------------|----------------|---------|--------------------------|
| für Beläge bis 3 mm, weich PVC for floorings up to 3 mm, soft PVC | 2,5 | Kart./box à 25 | grau/ grey | 52816-6 | 7,62/m 19,10/St./pcs. |
| | | | schwarz/ black | 52818-0 | |
| | | | braun/ brown | 52820-3 | |
| | | | beige/ beige | 52822-7 | |

364 PVC-Treppenkante 42 x 42 x 3 mm/ PVC stair nosing 42 x 42 x 3 mm

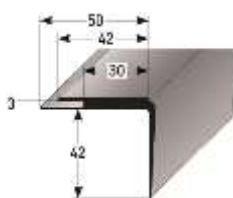

| | | | | | |
|--|-----|-------------------|----------------|---------|--------------------------|
| für Beläge bis 3 mm, weich PVC for floorings up to 3 mm, soft PVC | 2,5 | Kart./box à 20 | grau/ grey | 52824-1 | 8,44/m 21,06/St./pcs. |
| | | | schwarz/ black | 52826-5 | |
| | | | braun/ brown | 52828-9 | |
| | | | beige/ beige | 52830-2 | |

366 PVC-Treppenkante 42 x 57 mm/ PVC stair nosing 42 x 57 mm

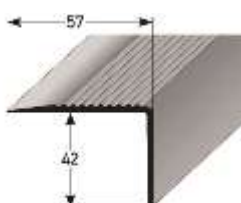

| | | | | | |
|-----------------------|-----|-------------------|----------------|---------|--------------------------|
| weich PVC soft PVC | 2,5 | Kart./box à 30 | grau/ grey | 52840-1 | 7,86/m 19,62/St./pcs. |
| | | | schwarz/ black | 52842-5 | |
| | | | braun/ brown | 52844-9 | |
| | | | beige/ beige | 52846-3 | |

12. ZUBEHÖR

12. ACCESSORIES



12. ZUBEHÖR / 12. ACCESSORIES

Bitte beachten Sie die Hinweise für Klebebänder im Abschnitt 13!

Please note the tips for adhesive tapes in section 13!

Spezialverlegeband / special tape

beidseitig klebender Acrylatkleber mit Gewebeträger, weitgehend weichmacherbeständig
 double-sided acrylat adhesive with fabric support, mostly plasticizer-resistant

| Klebezubehör | | | |
|----------------------|-----------------------------------|-----------|---------------|
| adhesive accessories | | | |
| Breite/width | Länge/ length (m) Rolle/roll à | Art./ref. | €/ Rolle/roll |
| 50 mm | 25 m | 15024-4 | 24,56 |

Verlegeband super/ tape super

beidseitig klebend, extreme Klebkraft, z.B. für Sockelleisten / double-sided extremely strong, e.g. for skirtings

| | | | |
|-------|------|---------|-------|
| 35 mm | 50 m | 15026-8 | 50,44 |
|-------|------|---------|-------|

Verlegeband/ tape

beidseitig klebend, z.B. für Sockelleisten / double-sided self-adhesive, e.g. for skirtings

| | | | |
|-------|------|---------|-------|
| 45 mm | 50 m | 15030-5 | 40,34 |
|-------|------|---------|-------|

Flachklebeband / flat tape



| | | | |
|-------|-------|---------|--------|
| 22 mm | 100 m | 15040-4 | 128,80 |
|-------|-------|---------|--------|

beidseitig klebend für Metallprofile, 1 Klebstoffstreifen 18 mm breit, 0,4 mm dick, auf Basis Synthesekautschuk

double-sided for metall profiles, 1 adhesive strip 18 mm wide, 0,4 mm thick, based on synthetic rubber

Flachschnurklebeband

flat corded tape



| | | | |
|-------|-------|---------|--------|
| 27 mm | 250 m | 15062-6 | 201,42 |
|-------|-------|---------|--------|

beidseitig klebend für Metallprofile, 2 Klebstoffstreifen, 6 mm breit, 0,8 mm dick

double-sided for metall profiles, 2 adhesive strips, 6 mm wide, 0,8 mm thick

Rundschnurklebeband

corded tape



| | | | |
|-------|-------|---------|-------|
| 28 mm | 100 m | 15052-7 | 96,60 |
|-------|-------|---------|-------|

beidseitig klebend für Metallprofile, 2 Klebstoffstreifen, 2,5 mm Durchmesser

double-sided for metall profiles, 2 adhesive strips, 2,5 mm diameter

Grundierung für Metallprofile/ primer for metall profiles

Für die Klebemontage empfehlen wir die Verwendung eines geeigneten Primers. Gerne beraten wir Sie dahingehend.



| | |
|-----------|-------------|
| Art./ref. | €/Stk./pcs. |
| 71956-4 | auf Anfrage |

We recommend using a suitable primer for adhesive mounting. We would be happy to advise you on this.

Montagekleber (Basis MSX-Polymer)

builders adhesive (based on MSX polymer)



| | Art./ref. | €/Stk./pcs. |
|---|-----------|-------------|
| Kartusche „FIX ALL FLEXI“ 470 g, weiß cartridge „FIX ALL FLEXI“ 470 g, white | 22245-3 | 34,24 |
| Kartusche „FIX ALL CRISTAL“ 300 g, transparent cartridge „FIX ALL CRISTAL“ 300 g, transparent | 22257-6 | 34,24 |
| Kartusche „FIX ALL TURBO“ 430 g, weiß cartridge „FIX ALL TURBO“ 430 g, white | 22258-3 | 37,42 |

12. ZUBEHÖR / 12. ACCESSORIES

Spanplattenschrauben PZD 1/ TORX TX10

chipboard screws cross slot PZD 1/ TORX TX10







Abpackungen à 500 Stück, sowohl im Beutel als auch im Karton erhältlich. Bitte bei der Bestellung angeben.

Packs à 500 pcs. are available in bags and also in boxes.

Please specify when you place your order.

| Größe/ dimension | Material/Farbe material/colour | Btl./VE bags/unit | Stückz./Btl. pcs./bag | Linsenkopf button head | | Senkkopf countersunk head | |
|---------------------|--|----------------------|--------------------------|---------------------------|-------------|------------------------------|-------------|
| | | | | Art./ref. | €/ Btl./bag | Art./ref. | €/ Btl./bag |
| 3x20 | Fe-Messing iron brass | 30 | 50 SB | 20031-4 | 2,50 | 20035-2 | 2,50 |
| | | 30 | 10 SB | 20032-1 | 0,72 | 20036-9 | 0,72 |
| | | 30 | 100 | 20033-8 | 4,22 | 20037-6 | 4,22 |
| | | 6 | 500 | 20034-5 | 20,16 | 20038-3 | 20,16 |
| | Fe-Nickel iron nickel | 30 | 50 SB | 20041-3 | 2,50 | 20045-1 | 2,50 |
| | | 30 | 10 SB | 20042-0 | 0,72 | 20046-8 | 0,72 |
| | | 30 | 100 | 20043-7 | 4,22 | 20047-5 | 4,22 |
| | | 6 | 500 | 20044-4 | 20,16 | 20048-2 | 20,16 |
| | Fe-bronze hell pulverbeschichtet bronze light powder coated | 30 | 50 SB | 16005-2 | 6,98 | 16025-0 | 6,98 |
| | | 30 | 10 SB | 16010-6 | 1,96 | 16030-4 | 1,96 |
| | | 30 | 100 | 16015-1 | 12,76 | 16035-9 | 12,76 |
| | | 6 | 500 | 16020-5 | 62,54 | 16040-3 | 62,54 |
| | Fe-bronze dunkel iron bronze dark | 30 | 50 SB | 20051-2 | 2,50 | 20055-0 | 2,50 |
| | | 30 | 10 SB | 20052-9 | 0,72 | 20056-7 | 0,72 |
| | | 30 | 100 | 20053-6 | 4,22 | 20057-4 | 4,22 |
| | | 6 | 500 | 20054-3 | 20,16 | 20058-1 | 20,16 |
| 3x25 | Fe-Messing iron brass | 30 | 50 SB | 20065-9 | 2,86 | 20061-1 | 2,86 |
| | | 30 | 10 SB | 20066-6 | 0,88 | 20062-8 | 0,88 |
| | | 30 | 100 | 20067-3 | 5,06 | 20063-5 | 5,06 |
| | | 6 | 500 | 20068-0 | 22,28 | 20064-2 | 22,28 |
| | Fe-Nickel iron nickel | 30 | 50 SB | 20075-8 | 2,86 | 20071-0 | 2,86 |
| | | 30 | 10 SB | 20076-5 | 0,88 | 20072-7 | 0,88 |
| | | 30 | 100 | 20077-2 | 5,06 | 20073-4 | 5,06 |
| | | 6 | 500 | 20078-9 | 22,28 | 20074-1 | 22,28 |
| | Fe-bronze hell pulverbeschichtet bronze light powder coated | 30 | 50 SB | 16045-8 | 7,54 | 16065-6 | 7,54 |
| | | 30 | 10 SB | 16050-2 | 2,04 | 16070-0 | 2,04 |
| | | 30 | 100 | 16055-7 | 13,76 | 16075-5 | 13,76 |
| | | 6 | 500 | 16060-1 | 67,82 | 16080-9 | 67,82 |
| | Fe-bronze dunkel iron bronze dark | 30 | 50 SB | 20085-7 | 2,86 | 20081-9 | 2,86 |
| | | 30 | 10 SB | 20086-4 | 0,88 | 20082-6 | 0,88 |
| | | 30 | 100 | 20087-1 | 5,06 | 20083-3 | 5,06 |
| | | 6 | 500 | 20088-8 | 22,28 | 20084-0 | 22,28 |
| 3x30 | Fe-Messing iron brass | 30 | 50 SB | 20091-8 | 3,52 | 20095-6 | 3,52 |
| | | 30 | 10 SB | 20092-5 | 0,94 | 20096-3 | 0,94 |
| | | 30 | 100 | 20093-2 | 6,40 | 20097-0 | 6,40 |
| | | 6 | 500 | 20094-9 | 30,72 | 20098-7 | 30,72 |
| | Fe-Nickel iron nickel | 30 | 50 SB | 20101-4 | 3,52 | 20105-2 | 3,52 |
| | | 30 | 10 SB | 20102-1 | 0,94 | 20106-9 | 0,94 |
| | | 30 | 100 | 20103-8 | 6,40 | 20107-6 | 6,40 |
| | | 6 | 500 | 20104-5 | 30,72 | 20108-3 | 30,72 |
| | Fe-bronze hell pulverbeschichtet bronze light powder coated | 30 | 50 SB | 16085-4 | 8,06 | 16105-9 | 8,06 |
| | | 30 | 10 SB | 16090-8 | 2,10 | 16110-3 | 2,10 |
| | | 30 | 100 | 16095-3 | 14,88 | 16115-8 | 14,88 |
| | | 6 | 500 | 16100-4 | 73,14 | 16120-2 | 73,14 |
| | Fe-bronze dunkel iron bronze dark | 30 | 50 SB | 20111-3 | 3,52 | 20115-1 | 3,52 |
| | | 30 | 10 SB | 20112-0 | 0,94 | 20116-8 | 0,94 |
| | | 30 | 100 | 20113-7 | 6,40 | 20117-5 | 6,40 |
| | | 6 | 500 | 20114-4 | 30,72 | 20118-2 | 30,72 |

12. ZUBEHÖR / 12. ACCESSORIES

| Spanplattenschrauben TORX TX10, Senkkopf | | | | | | |
|---|--|--------------------------|---|---------------------|---------------------------|--------------------|
| chipboard screws cross slot PZD 1/ TORX TX10 | | | | | | |
| Abbildung illustration | Material/Farbe material/colour | Stückz./Btl. pcs./bag | Größe/ dimension | Art./ref. | €/ Btl./bag | |
|  | schwarz black | Btl./bag à 100 | 3x20 | 72260-1 | 7,72 | |
| | | | 3x25 | 72262-5 | 8,48 | |
| | | | 3x30 | 72264-9 | 10,40 | |
| | Fe-Nickel iron nickel | Btl./bag à 100 | 3,5x25 | 16000-7 | 5,88 | |
| | | | 3,5x30 | 16001-4 | 7,46 | |
| | | | 3,5x40 | 16002-1 | 9,96 | |
| Emaille-beschichtete Schrauben, PZD 1/ TORX TX10, Senkkopf | | | | | | |
| enamel-coated screws PZD 1/ TORX TX10, countersunk head | | | | | | |
|  | dunkelgrau metallic/ dark grey | Btl./bag à 100 | 3x25 | 40120-9 | 31,48 | |
| | silber metallic/ silver metallic | | | 40270-1 | | |
| Profi-K-Spezialschraube, TX 10, Kopf 5,8 mm | | | | | | |
| professional-K screws, TX 10, head 5,8 mm | | | | | | |
|  | Fe-Nickel iron nickel | Btl./bag à 100 |  | 4x20 | 72516-9 | 15,42 |
| | | | | 4x25 | 72518-3 | 17,30 |
| | | | | 4x30 | 72520-6 | 19,20 |
| | | | | 4x35 | 72522-0 | 22,02 |
| | | | | 4x45 | 36640-9 | 22,28 |
| | Fe-Messing iron brass | | | 4x45 | 36630-0 | 22,28 |
| | Fe-bronze hell iron bronze light | | | 4x45 | 36645-4 | 30,76 |
| Fe-bronze dunkel iron bronze dark | 4x45 | 36650-8 | 22,28 | | | |
| Edelstahlschrauben, Senkkopf, Kreuzschlitz, Beutel à 100 Stk. | | | | | | |
| stainless steel screw, countersunk head, cross slot, bag à 100 pcs. | | | | | | |
|  | Größe/ dimension | Art./ref. | €/100 Stk./pcs. | Größe/ Dimension | Art./ref. | €/100 Stk./pcs. |
| | 3x20 | 39330-6 | 10,72 | 3,5x16 | 39360-3 | 15,54 |
| | 3x25 | 39340-5 | 13,08 | 3,5x20 | 39365-8 | 17,06 |
| | 3x30 | 39350-4 | 13,98 | 3,5x25 | 39370-2 | 18,52 |
| | 4x40 | 39400-6 | 26,42 | 3,5x30 | 39380-1 | 20,44 |
| | 4x45 | 39410-5 | 29,24 | 3,5x40 | 39390-0 | 22,04 |
| | 4x50 | 39420-4 | 32,02 | | | |
| Dübel | | | | | | |
| dowels | | | | | | |
| Abbildung illustration | Maß/size (mm) | VE unit | Stk./Verpack. pcs./pack | Art./ref. | €/Btl./Kart. €/bag/box | |
| Spreiz-Dübel expansion dowel  | 5 mm | 10 | Btl./bag à 20 SB | 20151-9 | 1,04 | |
| | | 10 | Btl./bag à 100 | 20150-2 | 3,76 | |
| | | 5 | Btl./bag à 500 | 20160-1 | 18,06 | |
| | 6 mm | 10 | Btl./bag à 20 SB | 20171-7 | 1,52 | |
| | | 10 | Btl./bag à 100 | 20170-0 | 4,72 | |
| | | 5 | Btl./bag à 500 | 20172-4 | 23,78 | |
| Quattro-Dübel quattro dowels Die Problemlöser! Problem solver!  | 5 mm | 10 | Btl./bag à 100 | 20161-8 | 14,80 | |
| | 6 mm | 10 | Btl./bag à 100 | 20165-6 | 19,10 | |

12. ZUBEHÖR / 12. ACCESSORIES

Schrauben für Mini-APL- & SKD-System

screws for MINI-APL + SKD -system

| Material/Farbe material/colour | Btl./VE bags/unit | 2,9 x 5,5 mm | | 2,9 x 9,0 mm | |
|--|----------------------|--------------|--------------------|--------------|--------------------|
| | | Art./ref. | €/100 Stk./pcs. | Art./ref. | €/100 Stk./pcs. |
| FE-verzinkt/ iron galvanized | 1 | 20986-7 | 12,14 | 20991-1 | 12,68 |
| FE-vermessingt/ iron brass plated | | 20987-4 | 12,14 | 20992-8 | 12,68 |
| FE-bronze dunkel/ iron bronze dark | | 20988-1 | 12,14 | 20993-5 | 12,68 |
| FE-gelb verzinkt/ iron yellow galvanized | | 20989-8 | 12,14 | 20994-2 | 12,68 |

Schrauben für APL- & SLP-System

screws for APL- and SLP-systems

| Material/Farbe material/colour | Btl./VE bags/unit | 2,9 x 7 mm | | 2,9 x 11 mm | | 2,9 x 17 mm | |
|--|----------------------|------------|--------------------|-------------|--------------------|-------------|--------------------|
| | | Art./ref. | €/100 Stk./pcs. | Art./ref. | €/100 Stk./pcs. | Art./ref. | €/100 Stk./pcs. |
| FE-verzinkt iron galvanized | 1 | 20971-3 | 12,14 | 70902-2 | 13,36 | 20981-2 | 13,64 |
| FE-vermessingt iron brass plated | | 20972-0 | 12,14 | 70904-6 | 13,36 | 20982-9 | 13,64 |
| FE-bronze dunkel iron bronze dark | | 20973-7 | 12,14 | 70906-0 | 13,36 | 20983-6 | 13,64 |
| FE-gelb verzinkt iron yellow galvanized | | 20974-4 | 12,14 | 70908-4 | 13,36 | 20984-3 | 13,64 |

| Material/Farbe material/colour | Btl./VE bags/unit | 2,9 x 7 mm | | 2,9 x 13 mm | | 2,9 x 17 mm | |
|-----------------------------------|----------------------|------------|--------------------|-------------|--------------------|-------------|--------------------|
| | | Art./ref. | €/100 Stk./pcs. | Art./ref. | €/100 Stk./pcs. | Art./ref. | €/100 Stk./pcs. |
| Edelstahl stainless steel | 1 | 20975-1 | 12,94 | 70910-7 | 13,88 | 20985-0 | 14,64 |

Extra Befestigungszubehör für Reparaturwinkel H15, H20, H38

extra fixing accessories for repair angle H15, H20, H38

| | Maß/size (mm) | Material/Farbe material/colour | Stück/Btl. pcs./bag | Art./ref. | €/ Btl./bag |
|----------------------------|------------------|-----------------------------------|------------------------|-----------|-------------|
| Ringnägel riffled nails | 2,2/ 2,4 x 27 mm | Fe-Nickel iron nickel plated | 50 | 20181-6 | 1,38 |
| | | | 100 | 20180-9 | 2,52 |
| | | | 500 | 20182-3 | 11,82 |
| | | Fe-Messing iron brass plated | 50 | 20201-1 | 1,38 |
| | | | 100 | 20200-4 | 2,52 |
| | | | 500 | 20202-8 | 11,82 |
| | | Fe-Bronze iron bronze plated | 50 | 20211-0 | 1,38 |
| | | | 100 | 20210-3 | 2,52 |
| | | | 500 | 20212-7 | 11,82 |

Wegmarkierungsronden aus 2 mm Edelstahl matt

trail marker ronden out of 2 mm stainless steel matt

| | Durchmesser/ diameter (mm) | Art./ref. | €/ Stk./pcs. |
|--|-------------------------------|-----------|--------------|
| Wegmarkierungs- ronden trail marker ronden | 10 | 71400-2 | 2,32 |
| | 15 | 71402-6 | 3,50 |
| | 24 | 71404-0 | 4,66 |

Andere Abmaße auf Anfrage. / Other dimensions on request.

12. ZUBEHÖR / 12. ACCESSORIES

| Leistenstifte | | | | | | |
|---------------|-----------------------------------|------------------|----------------------------|------------|-----------|---------------------------|
| pins | | | | | | |
| | Material/Farbe material/colour | Maß/size (mm) | Stk./Verpack. pcs./pack | VE unit | Art./ref. | €/Btl./Kart. €/bag/box |

1,5 mm Leistenstifte Stahl, gehärtet

1,5 mm pins steel,
hardened



| | | | | | |
|---|--------|--|----|---------|-------|
| verzinkt galvanized | 1,5x20 | Karton à 1000 Stk. box à 1000 pcs. | 5 | 20600-2 | 22,02 |
| | 1,5x25 | | | 20610-1 | 25,72 |
| | 1,5x30 | | | 20620-0 | 26,92 |
| | 1,5x35 | | | 20630-9 | 30,36 |
| blank bare | 1,5x20 | Karton à 1000 Stk. box à 1000 pcs. | 5 | 20640-8 | 16,80 |
| | 1,5x25 | | | 20650-7 | 17,52 |
| | 1,5x30 | | | 20660-6 | 18,16 |
| | 1,5x35 | | | 20670-5 | 20,00 |
| vermessingt, lackiert brass plated, painted | 1,5x25 | Beutel à 100 Stk. bag à 100 pcs. | 10 | 20680-4 | 4,56 |
| | 1,5x30 | | | 20685-9 | 5,38 |
| | 1,5x35 | | | 20690-3 | 6,70 |
| | 1,5x25 | Karton à 1000 Stk. box à 1000 pcs. | 5 | 20681-1 | 35,94 |
| | 1,5x30 | | | 20686-6 | 44,12 |
| | 1,5x35 | | | 20691-0 | 57,32 |

1,4 mm Leistenstifte Stahl, gehärtet

1,4 mm pins steel,
hardened

mit geschlagener
Spitze, für normale
Beanspruchung
with hammered tip,
for normal use



| | | | | | |
|-------------------------------|--------|------------------|----|---------|-------|
| verzinkt galvanized | 1,4x20 | Kart./box à 1000 | 5 | 20300-1 | 12,76 |
| | | Btl./bag à 1000 | 5 | 20302-5 | 12,80 |
| | | Btl./bag à 100 | 10 | 20301-8 | 1,96 |
| | 1,4x25 | Kart./box à 1000 | 5 | 20350-6 | 14,38 |
| | | Btl./bag à 1000 | 5 | 20352-0 | 14,56 |
| | | Btl./bag à 100 | 10 | 20351-3 | 2,00 |
| | 1,4x30 | Kart./box à 1000 | 5 | 20400-8 | 15,86 |
| | | Btl./bag à 1000 | 5 | 20402-2 | 16,02 |
| | | Btl./bag à 100 | 10 | 20401-5 | 2,04 |
| | 1,4x35 | Kart./box à 1000 | 5 | 20450-3 | 17,40 |
| | | Btl./bag à 1000 | 5 | 20452-7 | 17,52 |
| | | Btl./bag à 100 | 10 | 20451-0 | 2,06 |

"ELOXAL-FIX" Schleifreiniger, mittel, mit Körnung 120

zur Beseitigung von leichten
Oberflächenverunreinigungen eloxierter Profile
(nicht geeignet für eine durchbrochene Eloxalschicht)

"ELOXAL-FIX" cleaning block, medium, with grain size 120
for removing facile surface contaminants at anodized profiles
(not suitable for a perforated anodized coating)

| Art./ref. | €/Stk./pcs. |
|-----------|-------------|
| 22281-1 | 23,32 |



12. ZUBEHÖR / 12. ACCESSORIES

| Türstopper | | | | | |
|--------------|---------------|-------------------------|---------|-----------|-------------|
| door stopper | | | | | |
| | Maß/size (mm) | Stk./Verpack. pcs./pack | VE unit | Art./ref. | €/Stk./pcs. |

249 hochwertiger Türstopper für Wandmontage/ high quality door stopper for wand installation

Gesamttiefe 80 mm,
Schlüsselweite 24 mm
depth: 80 mm,
wrench opening: 24 mm



| | | | | |
|------------------------------------|------------------------------------|-------------|---------|-------|
| Messing brass | Karton à 10 Stk. box à 10 pcs. | 1 Kart./box | 20598-2 | 24,54 |
| | SB Beutel à 1 Stk. bag à 1 pcs. | 10 St./pcs | 20599-9 | 25,44 |
| vernickelt nickel plated | Karton à 10 Stk. box à 10 pcs. | 1 Kart./box | 20360-5 | 26,48 |
| | SB Beutel à 1 Stk. bag à 1 pcs. | 10 St./pcs | 20361-2 | 27,42 |

79 hochwertiger Türstopper montagefertig/ high quality door stopper

Gesamthöhe 35 mm,
Durchmesser 28 mm
height 35 mm, diameter 28 mm



| | | | | |
|------------------------------------|------------------------------------|-------------|---------|-------|
| Messing brass | Karton à 10 Stk. box à 10 pcs. | 1 Kart./box | 20590-6 | 12,30 |
| | SB Beutel à 1 Stk. bag à 1 pcs. | 10 St./pcs | 20592-0 | 13,42 |
| vernickelt nickel plated | Karton à 10 Stk. box à 10 pcs. | 1 Kart./box | 20591-3 | 14,20 |
| | SB Beutel à 1 Stk. bag à 1 pcs. | 10 St./pcs | 20593-7 | 15,36 |

248 Türstopper schwere Ausführung/ door stopper, heavy

Gesamthöhe 44 mm,
Durchmesser 38 mm
height 44 mm, diameter 38 mm







| | | | | |
|------------------------------------|------------------------------------|-------------|---------|-------|
| Messing brass | Karton à 10 Stk. box à 10 pcs. | 1 Kart./box | 20594-4 | 20,74 |
| | SB Beutel à 1 Stk. bag à 1 pcs. | 10 St./pcs | 20596-8 | 21,72 |
| vernickelt nickel plated | Karton à 10 Stk. box à 10 pcs. | 1 Kart./box | 20595-1 | 23,20 |
| | SB Beutel à 1 Stk. bag à 1 pcs. | 10 St./pcs | 20597-5 | 24,16 |

andere Abmessungen
auf Anfrage

other dimensions on demand

Heizrohrrosetten aus 3 mm Edelstahl matt

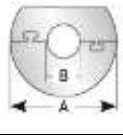
heating pipe rosettes, 3 mm stainless steel matt

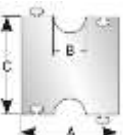
| | | AxBxC (mm) | | Art./ref. | €/Stk./pcs. |
|--|---|--------------|--|-----------|-------------|
| 278 Heizrohrrosette Komplettkreis heating pipe rosette full circle |  | 50 x 12 |  | 14400-7 | 22,72 |
| | | 50 x 15 | | 14402-1 | |
| | | 50 x 18 | | 14404-5 | |
| | | 50 x 22 | | 14406-9 | |
| 279 Heizrohrrosette mit Wandteil heating pipe rosette with wall trim |  | 50 x 12 |  | 14416-8 | 22,72 |
| | | 50 x 15 | | 14418-2 | |
| | | 50 x 18 | | 14420-5 | |
| | | 50 x 22 | | 14422-9 | |
| 280 Zwischenstück kombi- nierbar, für Doppelrohre insert pieces, for combination for double pipes |  | 50 x 12 x 50 |  | 14408-3 | 31,16 |
| | | 50 x 15 x 50 | | 14410-6 | |
| | | 50 x 18 x 50 | | 14412-0 | |
| | | 50 x 22 x 50 | | 14414-4 | |

C = Abstand der Heizrohre/ distance between heating pipes

12. ZUBEHÖR / 12. ACCESSORIES

***Auslaufartikel**
 discontinued item

Lüftungsbleche aus Aluminium

aluminum vents

Lüftungsblech/
vents 70 x 70 mm

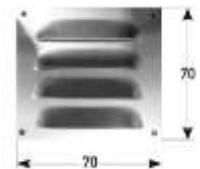

110 x 110 mm

150 x 150 mm

| Farbe/ colour | VE/ unit | Art./ref. | €/St./ pcs. | SB-Verpackung/ self-service pack | | | €/Beutel/ bag |
|---|----------|-----------|--------------|----------------------------------|--------------------|-----------|---------------|
| | | | | VE/unit | St./Btl./ pcs./bag | Art./ref. | |
| silberfarbig eloxiert silver anodized | 25 | 21013-9 | 1,44 | 10 Btl./ bag | à 2 St./pcs. | 21014-6 | 3,94 |
| goldfarbig eloxiert gold anodized | | 21000-9 | 2,66 | | à 4 St./pcs. | 21015-3 | 6,84 |
| weiß , PVC-beschichtet white, PVC-coated | | 21025-2 | 2,76 | | à 2 St./pcs. | 21001-6 | 6,38 |
| | | | à 4 St./pcs. | | 21002-3 | 11,70 | |
| | | | | | à 2 St./pcs. | 21026-9 | 6,58 |
| | | | | | à 4 St./pcs. | 21027-6 | 12,12 |
| weiß , PVC-beschichtet white, PVC-coated | 10 | 21305-5 | 4,46 | | | | |
| Kupfer antik , PVC-beschichtet * antique copper, PVC-coated | | 21300-0 * | | | | | |
| weiß , PVC-beschichtet white, PVC-coated | 10 | 21315-4 | 7,78 | | | | |
| Kupfer antik , PVC-beschichtet * antique copper, PVC-coated | | 21310-9 * | | | | | |

Lüftungsblech/
vents

Ø 70 mm



| | | | | | | | |
|---|----|-----------|------|--------------|--------------|-----------|-------|
| silberfarbig eloxiert silver anodized | 25 | 21070-2 | 1,44 | 10 Btl./ bag | à 2 St./pcs. | 21071-9 | 3,94 |
| goldfarbig eloxiert gold anodized | | 21050-4 | 2,66 | | à 4 St./pcs. | 21072-6 | 6,84 |
| weiß , PVC-beschichtet white, PVC-coated | | 21056-6 | 2,76 | | à 2 St./pcs. | 21051-1 | 6,38 |
| Kupfer antik , PVC-beschichtet * antique copper, PVC-coated | | 21053-5 * | 2,76 | | à 4 St./pcs. | 21052-8 | 11,70 |
| | | | | | à 2 St./pcs. | 21057-3 | 6,58 |
| | | | | | à 4 St./pcs. | 21058-0 | 12,12 |
| | | | | | à 2 St./pcs. | 21054-2 * | 6,58 |
| | | | | | à 4 St./pcs. | 21055-9 * | 12,12 |

Lüftungsblech/
vents



| | | | | | | | |
|---|----|-----------|------|--------------|--------------|-----------|-------|
| silberfarbig eloxiert silver anodized | 25 | 21063-4 | 1,44 | 10 Btl./ bag | à 2 St./pcs. | 21064-1 | 3,94 |
| goldfarbig eloxiert gold anodized | | 21060-3 | 2,66 | | à 4 St./pcs. | 21065-8 | 6,84 |
| weiß , PVC-beschichtet white, PVC-coated | | 21040-5 | 2,76 | | à 2 St./pcs. | 21061-0 | 6,38 |
| Kupfer antik , PVC-beschichtet * antique copper, PVC-coated | | 21043-6 * | 2,76 | | à 4 St./pcs. | 21062-7 | 11,70 |
| | | | | | à 2 St./pcs. | 21041-2 | 6,58 |
| | | | | | à 4 St./pcs. | 21042-9 | 12,12 |
| | | | | | à 2 St./pcs. | 21044-3 * | 6,58 |
| | | | | | à 4 St./pcs. | 21045-0 * | 12,12 |

Lüftungsblech/
vents



| | | | | | | | |
|---|----|-----------|------|--------------|--------------|-----------|-------|
| silberfarbig eloxiert silver anodized | 25 | 21073-3 | 1,34 | 10 Btl./ bag | à 2 St./pcs. | 21074-0 | 3,74 |
| goldfarbig eloxiert gold anodized | | 21030-6 | 2,56 | | à 4 St./pcs. | 21075-7 | 6,42 |
| weiß , PVC-beschichtet white, PVC-coated | | 21036-8 | 2,66 | | à 2 St./pcs. | 21031-3 | 6,16 |
| Kupfer antik , PVC-beschichtet * antique copper, PVC-coated | | 21033-7 * | 2,66 | | à 4 St./pcs. | 21032-0 | 11,28 |
| | | | | | à 2 St./pcs. | 21037-5 | 6,38 |
| | | | | | à 4 St./pcs. | 21038-2 | 11,70 |
| | | | | | à 2 St./pcs. | 21034-4 * | 6,38 |
| | | | | | à 4 St./pcs. | 21035-1 * | 11,70 |

Lüftungsblech 60 x 200 mm/ vents 60 x 200 mm

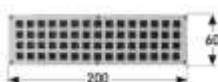

| | | | | | | | |
|--|----|---------|------|--------------|--------------|---------|-------|
| weiß , PVC-beschichtet white, PVC-coated | 25 | 21190-7 | 6,96 | 10 Btl./ bag | à 2 St./pcs. | 21201-0 | 14,98 |
|--|----|---------|------|--------------|--------------|---------|-------|

Lüftungsblech 60 x 400 mm/ vents 60 x 400 mm

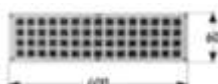

| | | | | | | | |
|--|----|---------|-------|--------------|--------------|---------|-------|
| weiß , PVC-beschichtet white, PVC-coated | 25 | 21240-9 | 13,64 | 10 Btl./ bag | à 2 St./pcs. | 21241-6 | 28,32 |
|--|----|---------|-------|--------------|--------------|---------|-------|

13. HINWEISE & AGB

13. HINTS + TERMS AND CONDITIONS



13. HINWEISE & AGB/ 13. ADVICE + TERMS AND CONDITIONS

Verlegehinweise

1. Für Edelstahlprodukte: Unser Produkte werden, wenn nichts anderes angegeben ist, aus Edelstahl Werkstoff 1.4016 (poliert) und 1.4301 (V2A) für den chemisch nicht belasteten Innen- und Außenbereich hergestellt. Für chemisch belastete Bereiche können wir auf Anfrage die Produkte auch aus V4A Werkstoff 1.4571 fertigen.

2. Für die Klebemontage: Für die Klebemontage empfehlen wir die Verwendung eines geeigneten Primers. Gerne beraten wir Sie dahingehend.

3. Für Klebebänder: Der Untergrund muss fest, trocken, staub- und fettfrei sein!
Alle Klebebänder sind besonders umweltfreundlich, da lösungsmittelfrei!

Spezialverlegeband: als Untergrund eignen sich alle Flächen mit glatten, festen Oberflächen wie Gips, Keramik, Metall, Holz sowie festhaftende Tapete oder Farbanstrich

Verlegeband Super: speziell für rauhe, poröse Oberflächen wie Mauerwerk, Beton oder Putz (sofern nicht absandend)

4. Für selbstklebende Produkte:

Der Untergrund muss trocken, staub- und fettfrei, sowie gerade und tragfähig sein, um einen Klebekontakt von 100% zu erreichen. Ungeübte sollten vorab das Profil mit Trägerpapier mehrfach trocken auflegen. Notfalls Richtmarkierungen oder Anschläge verwenden, da die Profile in der Regel nur ein Mal verklebt werden können.

Bei Temperaturen über 80°C wird der Kleber stark elastisch bis flüssig.

Klebereste kann man mit Nitroverdünnung entfernen.

Trägerpapier nun abziehen und Aufkleben, dabei Klebebahn nicht mit Fingern berühren.

Verschiedene Faktoren können abstoßend wirken, wie z.B. Zementschleier, Teppichimprägnierung, Bodenbelagspflege, ausdünstende Beschichtungen, Restfeuchte.

Bitte Informationen beim jeweiligen Materiallieferanten einholen.

Bei Einsatz von Wölbprofilen im Fussboden + Objektbelastung kann es zum sogen. "**Walkeffekt**" kommen. Gibt das Profil beim Betreten in der Mitte nach unten nach (Kleber wird gewalkt), wird durch die Wölbung bedingte Steifheit des Profiles eine Hebelwirkung an den äusseren Enden nach oben erzeugt. Staub unterwandert den Kleber. Aufgrund dessen sollten die Profile **bauseits zusätzlich seitlich mit**

Montagekleber "Fix All" Art.-nr. 22245-3 fixiert werden.

Der "Walkeffekt" betrifft auch Treppenkanten. Der Einsatz von Selbstklebeband wird hier nicht empfohlen. Der Kleber bleibt dauerelastisch (wie bei Dehnungsfugen), ist aber nicht für die Verklebung unter Decken geeignet. Senkrechte Wandverklebungen, sowie Sockelleisten müssen mit "Fix All" gesichert werden.

Achtung: Viele Wandoberflächen sind abweisend! Bitte Informationen beim jeweiligen Materiallieferanten einholen.

Der Einsatz von selbstklebenden Produkten bei Brandschutztüren unterliegt der Genehmigung durch den Türenhersteller (Gewährleistungsfrage).

Die Klebkraft kann beträchtlich erhöht werden, wenn Profil und Untergrund mit Heißluft erwärmt werden.

5. Für Gleitschutzeinlagen:

Einlage 12/ 23/ 39 / 50 mm breit, selbstklebend

Die Klebenut der Treppenkantenprofile trocken, staub- und fettfrei machen (Richtlinien f. Selbstklebeprodukte).

Die Einlagen entsprechend der Profillänge ausrollen und vorschneiden. Schutzfolie nach und nach abziehen und Einlage mit Andrückrolle fest anpressen. Der Kleber der Gleitschutzeinlage hat nach 24 Stunden seine volle Klebkraft erreicht. Die Gleitschutzeinlage beim Verlegen nicht dehnen.

Den Überstand nicht abschneiden, da sich das Band auf die vorgeschchnittene Länge wieder zusammenzieht.

Reinigungsmittel, die den Kleber auflösen, sind nicht zu verwenden.

Einlage 27 mm breit, eben oder gerippt f. Kombi-Winkel

Die Einlagen entsprechend der Profillänge ausrollen und vorschneiden. Nun an das Profil anlegen und zentimeterweise eindrücken. Dabei nicht dehnen. Es ist mit einer Einlagenstreckung zu rechnen.

Die Einlage schrumpft nach einer gewissen Zeit in die vorgeschchnittene Länge zurück.

Bei sofortiger maßlicher Fertigstellung, besonders bei Gehrungsschnitten, ca. 50 mm

der **beiden Enden (rechts und links) mit Sekunden- oder Kontaktkleber (PVC-P/ Metall) fixieren.**

Gelegentliches Wechseln der Einlagen, je nach Verschleißgrad, sollte vorgesehen werden.

13. HINWEISE & AGB/ 13. ADVICE + TERMS AND CONDITIONS

Installation tips

1. For stainless steel: Unless otherwise stated, our products are made of stainless steel material 1.4016 (polished) and 1.4301 (V2A) for interior and exterior areas that are not exposed to chemical loads. For chemically contaminated areas, we can also manufacture the products from V4A material 1.4571 on request.

2. For adhesive assembly: We recommend using a suitable primer for adhesive mounting. We would be happy to advise you on this.

3. For adhesive tapes: The surface should be strong, dry, free of dust and any grease!

Special tape: suitable surfaces include smooth dry surfaces such as plaster, ceramic, metal, wood as well as glued wallpaper and painted walls

Tape super: especially suitable for rough and porous surfaces such as bricks, and concrete

All adhesive tapes are environmentally friendly as they do not contain solvents!

4. For all self-adhesive products:

The surface should be dry, free of dust and grease as well as straight and stable in order to achieve 100 % adhesive contact. If you are not experienced, try profiles with the protective film.

Use markings or other tools to help. Profiles usually can only be glued once.

At temperatures above 80 °C adhesive becomes very elastic and liquid.

Use nitro thinner to remove any adhesive leftover.

Remove protective film and stick the profiles into position, without touching the adhesive surface.

Some factors can influence the strength of the adhesive bond: e.g. cement residue, carpet impregnation, vapours of coatings, humidity. For more information please ask the supplier.

The use of some profiles and heavy usage can lead to a **"bulging effect"**.

If the profile is bent down slightly by stepping on it in the middle, the adhesive is "walked".

The outside edges of the profile are lifted slightly and dust can get on the adhesive

leaving the adhesive much less effective. **Fix the profiles laterally with builders adhesive to prevent this.**

"Fix All" Ref.-no. 22245-3. The "bulging effect" may also occur with stair nosings, but the use of self-adhesive tape is not recommended here. Although the glue stays elastic, its use is not recommended under ceilings.

Vertical installations need to be secured with "Fix All". Attention: Many wall surfaces do not bond!

For more information please ask the supplier.

For usage involving fire doors it is required to get a prior permission by the manufacturer.

The adhesive strength can be substantially increased, if the profiles or surface is warmed with hot air.

5. For anti-slip inserts:

Insert 12/ 23/ 39 / 50 mm wide, self-adhesive

The adhesive seam of the profiles needs to be free of dust, dirt and grease. Roll out the insert according to the profile's length and cut bit by bit. Remove the protective film and push the insert tightly on the profile with a roll. The adhesive will have reached its full strength after 24h.

Do neither stretch the insert during installation nor cut any surplus length of the insert.

It will revert back to its original size after some time.

Do not use any cleaning agents which dissolve the adhesive.

PVC insert 27 mm wide, smooth or ribbed for combination stair nosing

Roll out the inserts according to the length of the profiles and cut insert into the profile by pushing in 5 cm at a time, do not stretch the insert! Otherwise, it will revert back to its original length after some time.

After installing the insert, but especially when miter cuts were used, fix the ends of the inserts (5cm) with **contact adhesive or superglue**. Please expect to change the inserts occasionally, depending on usage.

13. HINWEISE & AGB/ 13. ADVICE + TERMS AND CONDITIONS

Liefer- und Zahlungsbedingungen

- Allgemeine Produktbeschreibungen, Zeichnungen, Muster, Abbildungen und Maße sind unverbindlich. Die Angaben sind daher nur nach schriftlicher Bestätigung verbindlich. Dies betrifft auch Auskünfte, Ratschläge und Empfehlungen unserer Mitarbeiter. Produktionsbedingte Farbabweichungen, Konstruktions- oder Formänderungen bleiben unter Vorbehalt, sofern keine erheblichen Änderungen des Kaufgegenstandes entstehen.
- Allen Lieferungen werden die z.Z. der Lieferung geltenden Preise und Rabatte zugrunde gelegt. Der Käufer erkennt die vorliegenden Verkaufsbedingungen als verbindlich an.
- Der Versand von Lagerware innerhalb Deutschlands erfolgt in der Regel innerhalb von 7 Werktagen (nach Vereinbarung auch kurzfristiger, Expresskosten werden vom Kunden getragen). Transportkosten und Lieferzeiten für Inselzustellungen sind separat zu erfragen.
Der Besteller hat bei Versendung der Ware an den von ihm benannten Bestimmungsort, im Rahmen seiner Mitwirkungspflicht, die erforderlichen Voraussetzungen für die Entgegennahme der Ware bei Anlieferung vor Ort zu schaffen. Das von uns beauftragte Liefer-/Zustellungsunternehmen ist nicht verpflichtet, am jeweiligen Bestimmungsort in unzumutbarer Weise nach dem Empfänger zu forschen. Kann die Ware nicht termingemäß zugestellt werden, weil der Empfänger am Bestimmungsort nicht festgestellt werden kann, gehen dadurch entstehende Zeitverzögerungen und Kosten für weitere Anfahrten zu Lasten des Bestellers.
Für Baustellenanlieferungen ist generell ein Telefonavis mit aktueller Telefonnummer auf Kundenkosten (+6 € netto) **Pflicht**, um Anlieferungsprobleme, Verzögerungen und Zusatzkosten zu vermeiden.
- Aus versandtechnischen Gründen sind alle im Katalog mit 2,7 m ausgezeichneten Profile nur 2,69 m lang (Handelsbezeichnung bleibt weiterhin 2,7 m). Bei Bestellungen innerhalb Deutschlands ab 450 € netto erfolgt die Lieferung frei Haus, unter 450 € wird eine Kostenpauschale von 25 € berechnet, unter 75 € erheben wir zusätzlich einen Mindermengenaufschlag von 8 €. Diese Bedingungen gelten für Lieferungen bis 2,69 m. Lieferungen über 2,69 m erfolgen nur mit Spedition. Die Transportkostenhöhe ergibt sich aus Gewicht und Länge der Sendung.
- Die Zahlungsfrist beträgt 10 Tage 3 % Skonto oder 30 Tage netto. Für Vorkasse, Nachnahme und Bankeinzug gelten 4 % Skonto. Bis zur vollständigen Bezahlung der gelieferten Ware bleibt diese Eigentum des Lieferanten. Bei Zahlungsverzug sind wir berechtigt Verzugszinsen entsprechend den gesetzlichen Bestimmungen zu berechnen.
- Gerichtsstand und Erfüllungsort für beide Vertragsteile ist Sitz des Lieferanten.
Schadenersatz- und Aufwendungsersatzansprüche des Käufers, gleich aus welchem Rechtsgrund, insbesondere wegen Verletzung von Pflichten aus einem Schuldverhältnis und aus unerlaubter Handlung, sind ausgeschlossen. Dies gilt nicht, soweit nach gesetzlichen Vorschriften oder Garantie zwingend gehaftet wird.
Bei Reklamationen von Transportschäden bitten wir Sie für Begutachtungen die Verpackung aufzuheben.
- Nach §§ 26 und 34 Bundesdatenschutzgesetz sind wir verpflichtet, Sie davon in Kenntnis zu setzen, dass wir Daten Ihrer Firma bei uns speichern und verarbeiten. Selbstverständlich sind davon nur solche Angaben betroffen, die geschäftsnotwendig sind und direkt aus unserer Geschäftsbeziehung stammen.
- Warenrücknahme erfolgt nur nach ausdrücklicher Genehmigung durch uns. Die Rücksendung ist in jedem Fall franko und in transportsicherer Verpackung vorzunehmen.
Bei Rücksendungen, die nicht auf unser Verschulden zurückzuführen sind, erheben wir eine Wiedereingliederungspauschale von 15%. Sonderanfertigungen werden nicht zurückgenommen.
- Bei Sonderlängenzuschnitten in Einzellängenanfertigung berechnen wir den anfallenden Materialverbrauch zuzüglich einem Arbeitsaufschlag von 15 %. Ab einer Serienfertigung von 30 Stück je Profil und Länge entfällt der Arbeitsaufschlag (Ausnahme: Läuferstangen).
- Alle Preise sind zuzüglich Mehrwertsteuer.
- Dieser Katalog, inkl. Liefer- & Zahlungsbedingungen, tritt ab 01.01.2024 in Kraft. Ältere Kataloge und die bisherigen Liefer- & Zahlungsbedingungen verlieren damit ihre Gültigkeit. Wir behalten uns vor kurzfristig unterjährig einen Teuerungsaufschlag einzuführen.

Umsatzsteueridentifikationsnummer: DE 141030233

AG Chemnitz HRB 2292

ILN 40 17589 00000 6



Unsere Bankverbindungen:

Deutsche Bank

IBAN: DE59 8707 0000 0747 1758 00

BIC: DEUTDE8CXXX

Commerzbank

IBAN: DE12 8708 0000 0660 3452 00

BIC: DRESDEFF870

13. HINWEISE & AGB/ 13. ADVICE + TERMS AND CONDITIONS

TERMS AND CONDITIONS

1. General product descriptions, drawings, pattern, illustrations and dimensions are not binding. The data are therefore binding only after written confirmation. This also applies to information, advice and recommendations of our employees. Production-related variations in colour, design or shape changes remain reserved, unless a significant change in the purchase item arises.
2. All deliveries are subject to the prices and discounts valid at the time of the delivery. The customer accepts the terms and conditions as legally binding.
3. Goods in stock are usually dispatched within 14 working days (or sooner after prior agreement, the customer may be subject to additional charges). The customer should make suitable arrangements to receive the goods at the specified address. Deliveries usually require a signature.
The delivery service may not search for the recipient at delivery time. If the goods cannot be delivered on time because the recipient cannot be determined at the destination, any resulting delays and costs for further delivery attempts will be borne by the customer.
For deliveries to construction sites, a telephone notification (+6 €) with a current telephone number is generally required at the customer's expense in order to avoid delivery problems, delays and additional costs.
4. For technical reasons, all the 2.7 m profiles in the catalog are only 2.69 m long (trade name remains 2.7 m). These terms apply to deliveries. Deliveries over 2,69 m are only possible with forwarding. The transport cost is calculated from the weight and length of the consignment.
5. Payment within 10 days permits a 3 % discount. Payment within 30 days of the net amount. Pre-payment, cash on delivery, or bankers draft are subject to a 4 % discount. Goods stay the property of the manufacturer until they are fully paid. For late payments we charge interest according to law.
6. Court of jurisdiction and place of fulfillment for both parties to a contract is the registered office of the supplier. In case of complaints about transport damages please retain the packaging for appraisals.
7. According to §§ 26 and 34 of the German Data Protection Act we are obliged to let you know that we store and process data of your business. We only store and process data which are necessary for conducting business and directly originate from our business relation.
8. Goods returns are only accepted after explicit prior permission by us. The return should be postage paid and the goods packed in suitable packaging. For returns which are not due to our mistakes we charge a 15% restocking fee. Custom made orders are not returnable.
9. Custom lengths are chargeable at cost of materials plus 15% extra labour costs. For custom orders of 30 pieces or more of a single profile and length, we waive the additional labour costs (exception: stair rods).
10. All prices are exclusive of VAT.
11. This catalog, including delivery and payment conditions, comes into force on 01.01.2024. Older catalogs and the previous terms of delivery and payment lose their validity. We reserve the right to introduce a surcharge at short notice during the year.

VAT registration number: DE 141030233

Trade register no: AG Chemnitz HRB 2292

ILN 40 17589 00000 6



Our bank details:

Deutsche Bank

IBAN: DE59 8707 0000 0747 1758 00

BIC: DEUTDE8CXXX

Commerzbank

IBAN: DE12 8708 0000 0660 3452 00

BIC: DRESDEFF870



EDELSTAHL-TREPPENKANTEN (Werkstoff 1.4301)

Treppenkanten mit profilierter Riffelung 1,5 mm stark, **Rutschhemmung R10**

10 x 30 x 1,5 mm



20 x 30 x 1,5 mm



30 x 30 x 1,5 mm

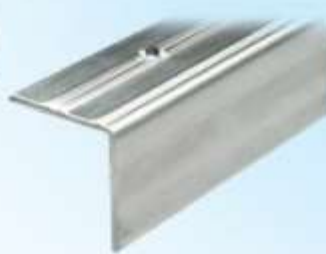

20 x 40 x 1,5 mm

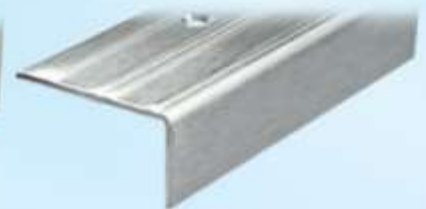

Treppenkanten mit gefräster Riffelung 3,0 mm stark

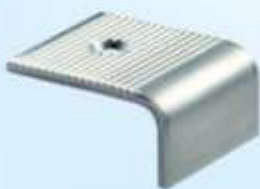

20 x 40 x 3 mm



28 x 50 x 3 mm



30 x 30 x 3 mm



40 x 40 x 1,5 mm

Einschubprofile mit Nase 1,5 mm stark

Höhe des Einschubes nach Bedarf



10 x 40 x 1,5 mm



10 x 40 x 1,5 mm

auch für runde Stufen möglich,
gebogen nach Schablone,
Radius oder Skizze

Einschubprofil mit Nase

Sicherheitsriffelung 3,0 mm



10 x 40 x 3 mm

EDELSTAHL-TREPPENKANTEN (Werkstoff 1.4301)

Treppenkanten mit Prägelochung 1,5 mm stark. **Rutschhemmung R12**

10 x 30 x 1,5 mm



10 x 30 x 1,5 mm (Anker)



20 x 40 x 1,5 mm



mit Anker: zum Einbetten in Beton oder zum nachträglichen Einkleben mit Spezialkleber (Diebstahlschutz)

ohne Anker: zum nachträglichen Verschrauben auf der Stufe



25 x 60 x 1,5 mm



25 x 80 x 1,5 mm



50 x 80 x 1,5 mm

Treppenkanten mit Prägelochung kommen bei Einrichtungen wie Bahnhöfen, Flughäfen, Skigebieten, Clubs, Diskotheken, Seniorenheimen, Krankenhäusern, Ämtern und Behörden zum Einsatz. Sie können aber auch hervorragend zur Treppensanierung eingesetzt werden.



Läuferstange 25 mm

Messing poliert,
lackiert



∅ 25 x 4 mm

Läuferstange 10 mm

Messing poliert,
lackiert

∅ 10 x 0,8 mm
mit & ohne Stahlkern



Läuferstange 16 mm

Messing poliert,
lackiert



∅ 16 x 3 mm

Läuferstange 10 mm

Edelstahl poliert

∅ 10 x 1,5 mm



Knauf

Zepter

Eichel

Krone

Zylinder

Läuferstange 10 mm

Weiß beschichtet

∅ 10 x 1,5 mm



Läuferstange 16 mm

Edelstahl
matt geschliffen



∅ 16 x 1 und 2 mm

Läuferstange 10 mm

Schwarz matt

∅ 10 x 1,5 mm



Dreikantläuferstange 16 mm

Messing poliert & lackiert,
Messing vernickelt

∇ 16 x 16 mm



Läuferstange 10 mm

Kupfer antik

∅ 10 x 1,5 mm



Läuferstange 13 mm

Messing poliert & lackiert,
Edelstahl poliert und matt geschliffen

∅ 13 x 1 mm
mit & ohne Stahlkern



Läuferstange 10 mm

Edelstahl
matt geschliffen

∅ 10 x 1,5 mm



∅ 16

∅ 13

∅ 10

Klappösen
offen oder geschlossen



Teppichnagel
30 mm

Teppich-
schraube

Unterlegscheibe
∅ 17

Buchse

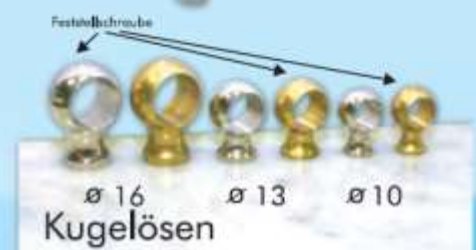

Festboltschraube

∅ 16

∅ 13

∅ 10

Kugelösen



PROFILE ZUM BIEGEN

Artikel, die mit diesen Zeichen versehen sind, stanzen und biegen wir für Sie nach Angabe des Radius oder nach Schablone.



Treppenkanten



Einschubprofile



Einfäßschienen



Profile für Laminat / Parkett

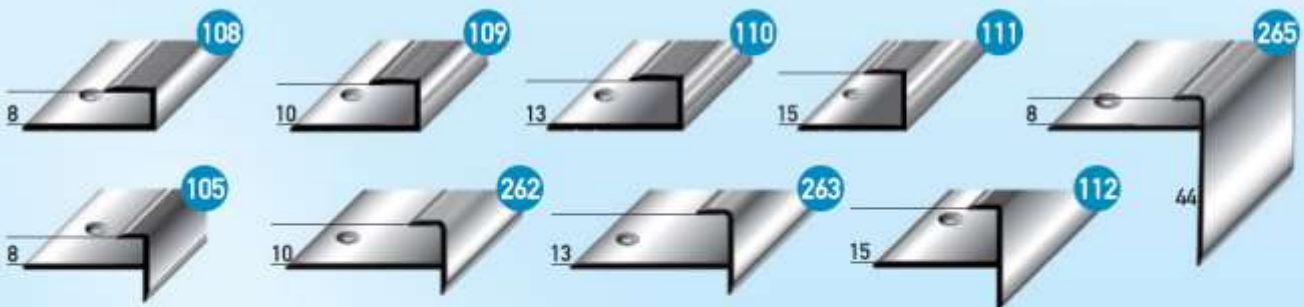

T-Profile



Treppenkanten mit abriebfester und nachleuchtender Spezialemailierung

für bodennahe Leitsysteme nach BGR 216

Krankenhäuser, Seniorenheime, öffentl. Gebäude, Schiffe, Flughäfen, Tiefgaragen, Hotels usw.

20 x 40 mm

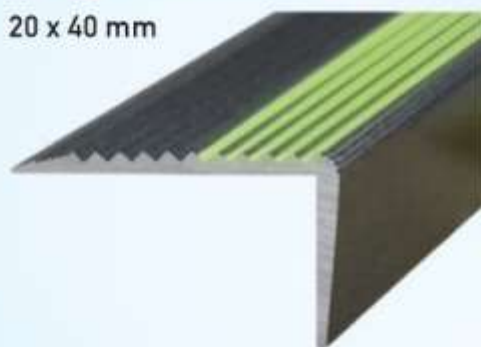

Leuchtzeit:

1 Stunde stark bei einer Mindestbeleuchtung von 100 Lux für ca. 5 min.

Alu-Profil mit lang nachleuchtendem Email, unbegrenzt oft wiederholbarer Nachleuchteffekt. Vollständige Beschichtung möglich - auch für andere Profile.

Eigenschaften:

abriebfest, desinfizierbar, keimabweisend, witterungsbeständig.

Das Material besteht aus ungiftigem und gefahrungsfreiem Erdalkalialuminat und ist als Aluschrott recyclingfähig.

Schwarz
20 x 40

Grün
20 x 40

Rot
20 x 40

Treppenkante mit LED-Beleuchtung

für Krankenhäuser, Seniorenheime, öffentliche Gebäude, Schiffe, Flughäfen, Tiefgaragen, Hotels, Gaststätten, Diskotheken, usw.

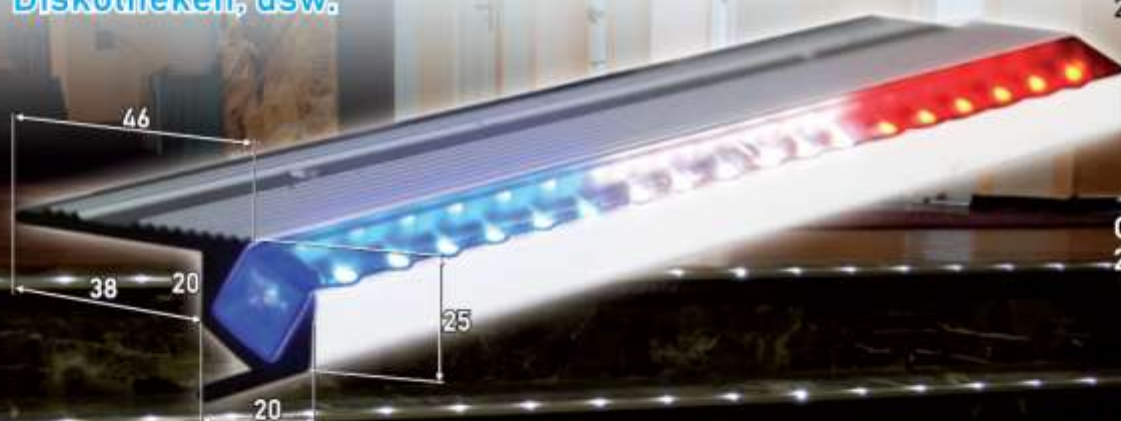

Blau
20 x 40

Gold
20 x 40

Profil-Farben: Silber, Gold, Bronze hell, Bronze dunkel, Edelstahlfarbig
LED-Farben: transparent, blau, rot, grün, gelb, lila - auf Wunsch mit Dimmer
Beleuchtungsleiste: 12V = 10 LED/lfm., alternativ 12V = 30 LED/lfm.
Preise auf Anfrage

Silber
metallisch
20 x 40

Dunkelgrau
20 x 40



Bohren / drilling



Profilieren / profiling



Abkanten / folding

Nachleuchtende Treppenketten
luminescent stair nosings

LED-beleuchtete Treppenketten
LED-illuminated stair nosings

Edelstahlbeschichtete Treppenketten
mit abriebfester Spezialemailierung
stainless steel coated stair nosings
with abrasion-resistant special enamelling

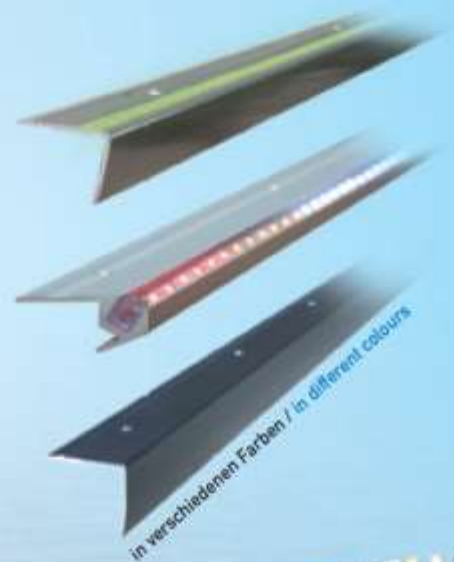

In verschiedenen Farben / in different colours



Jedes Profil in Folie eingeschumpft.
mit Schrauben, Dübel und EAN-Code versehen.
Every profile is shrink-wrapped in foil
with screws, dowels and European Article Number (EAN)



Auer Metallprofile GmbH
Muldenstraße 2
D-08280 Aue / Sachs.

Tel. +49 (0) 3771 / 28 68-0
Fax +49 (0) 3771 / 28 68-13
www.Auer-Metallprofile.de
info@Auer-Metallprofile.de



Unser Service für Sie:

Our service for you:

-  **Kurze Lieferzeiten**
(48 Stunden in Deutschland möglich)
short delivery times
(48 hours intrastate possible)
-  **Keine Mindestabnahmemenge**
minimum purchase quantity
-  **Zuschnitte für Sonderlängen**
special cuts of lengths
-  **Abkantprofile nach Skizze**
folded profiles according to your sketch
-  **Biegen von Profilen**
bending of profiles
-  **Oberflächenbearbeitung**
(vergolden, schleifen, polieren)
surface processing
(gilding, grinding, polishing)
-  **Flexible Farbgestaltung mit Eloxal-,
Emaill- und RAL-Farben**
Flexible colour design with anodized, enamel
and RAL colours

